

## ***COMMAND SERIES*** ***CH18-26, CH730-740*** ***HORIZONTAL CRANKSHAFT***



**KOHLER**  
engines

**BORN  
TO RUN™**

## Safety Precautions

To insure safe operations please read the following statements and understand their meaning. Also refer to your equipment owner's manual for other important safety information. This manual contains safety precautions which are explained below. Please read carefully.

### **WARNING**

Warning is used to indicate the presence of a hazard that *can* cause *severe* personal injury, death, or substantial property damage if the warning is ignored.

### **CAUTION**



Caution is used to indicate the presence of a hazard that *will* or *can* cause *minor* personal injury or property damage if the caution is ignored.

### **NOTE**

Note is used to notify people of installation, operation, or maintenance information that is important but not hazard-related.



### **For Your Safety!**

*These precautions should be followed at all times. Failure to follow these precautions could result in injury to yourself and others.*

 <b>WARNING</b>

<b>Explosive Fuel can cause fires and severe burns.</b>
Stop engine before filling fuel tank.



### **Explosive Fuel!**

Gasoline is extremely flammable and its vapors can explode if ignited. Store gasoline only in approved containers, in well ventilated, unoccupied buildings, away from sparks or flames. Do not fill the fuel tank while the engine is hot or running, since spilled fuel could ignite if it comes in contact with hot parts or sparks from ignition. Do not start the engine near spilled fuel. Never use gasoline as a cleaning agent.

 <b>WARNING</b>

<b>Rotating Parts can cause severe injury.</b>
Stay away while engine is in operation.



### **Rotating Parts!**

Keep hands, feet, hair, and clothing away from all moving parts to prevent injury. Never operate the engine with covers, shrouds, or guards removed.

 <b>WARNING</b>

<b>Hot Parts can cause severe burns.</b>
Do not touch engine while operating or just after stopping.

### **Hot Parts!**

Engine components can get extremely hot from operation. To prevent severe burns, do not touch these areas while the engine is running, or immediately after it is turned off. Never operate the engine with heat shields or guards removed.

 <b>CAUTION</b>

<b>Electrical Shock can cause injury.</b>
Do not touch wires while engine is running.

### **Electrical Shock!**

Never touch electrical wires or components while the engine is running. They can be sources of electrical shock.



<b>California Proposition 65 Warning</b>
Engine exhaust from this product contains chemicals known to the State of California to cause cancer, birth defects, or other reproductive harm.

## Safety Precautions (Cont.)



 <b>WARNING</b>

<p><b>Accidental Starts can cause severe injury or death.</b></p> <p>Disconnect and ground spark plug leads before servicing.</p>

**Accidental Starts!**  
**Disabling engine. Accidental starting can cause severe injury or death.** Before working on the engine or equipment, disable the engine as follows: 1) Disconnect the spark plug lead(s). 2) Disconnect negative (-) battery cable from battery.

 <b>WARNING</b>

<p><b>Carbon Monoxide can cause severe nausea, fainting or death.</b></p> <p>Do not operate engine in closed or confined area.</p>

**Lethal Exhaust Gases!**  
Engine exhaust gases contain poisonous carbon monoxide. Carbon monoxide is odorless, colorless, and can cause death if inhaled. Avoid inhaling exhaust fumes, and never run the engine in a closed building or confined area.

 <b>WARNING</b>

<p><b>Explosive Gas can cause fires and severe acid burns.</b></p> <p>Charge battery only in a well ventilated area. Keep sources of ignition away.</p>

**Explosive Gas!**  
Batteries produce explosive hydrogen gas while being charged. To prevent a fire or explosion, charge batteries only in well ventilated areas. Keep sparks, open flames, and other sources of ignition away from the battery at all times. Keep batteries out of the reach of children. Remove all jewelry when servicing batteries.

Before disconnecting the negative (-) ground cable, make sure all switches are OFF. If ON, a spark will occur at the ground cable terminal which could cause an explosion if hydrogen gas or gasoline vapors are present.

**Congratulations** – You have selected a fine four-cycle, twin cylinder, air-cooled engine. Kohler designs long life strength and on-the-job durability into each engine...making a Kohler engine dependable...dependability you can count on. Here are some reasons why:

- Efficient overhead valve design and full pressure lubrication provide maximum power, torque, and reliability under all operating conditions.
- Dependable, maintenance-free electronic ignition ensures fast, easy starts time after time.
- Kohler engines are easy to service. All routine service areas like the dipstick, oil fill, air cleaner, and spark plugs are easily and quickly accessible.
- Parts subject to the most wear and tear (like the cylinder liner\* and camshaft) are made from precision formulated cast iron. Because the cylinder liner\* can be rebored, these engines can last even longer.

\*Some CH25/26 engines have POWER-BORE™ Cylinders. These cylinders are plated with nickel-silicon to give increased power, virtually permanent cylinder life, superior oil control, and reduced exhaust emissions. These cylinders cannot be rebored.

- Every Kohler engine is backed by a worldwide network of over 10,000 distributors and dealers. Service support is just a phone call away. Call 1-800-544-2444 (U.S. & Canada) for Sales & Service assistance.

To keep your engine in top operating condition, follow the maintenance procedures in this manual.

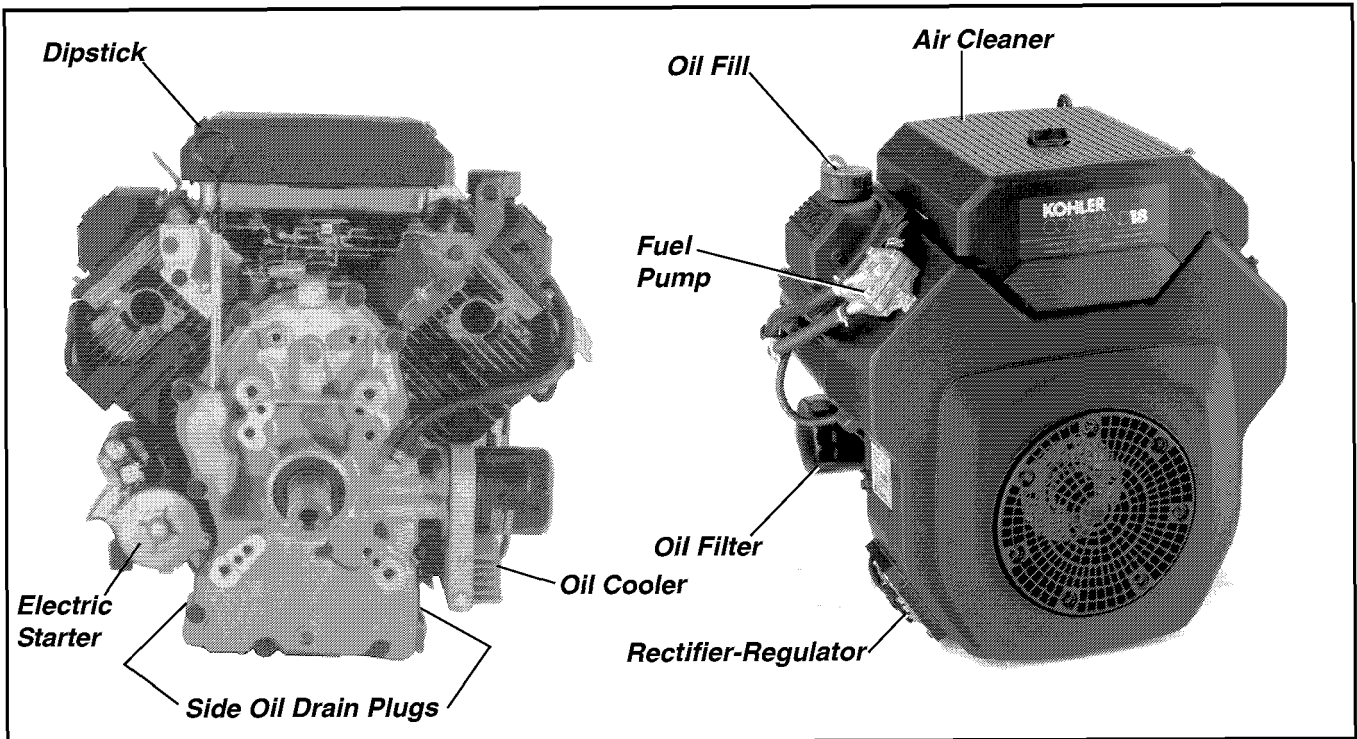


Figure 1. Typical Command Horizontal Shaft Engine (CH18-25, CH730, 740).

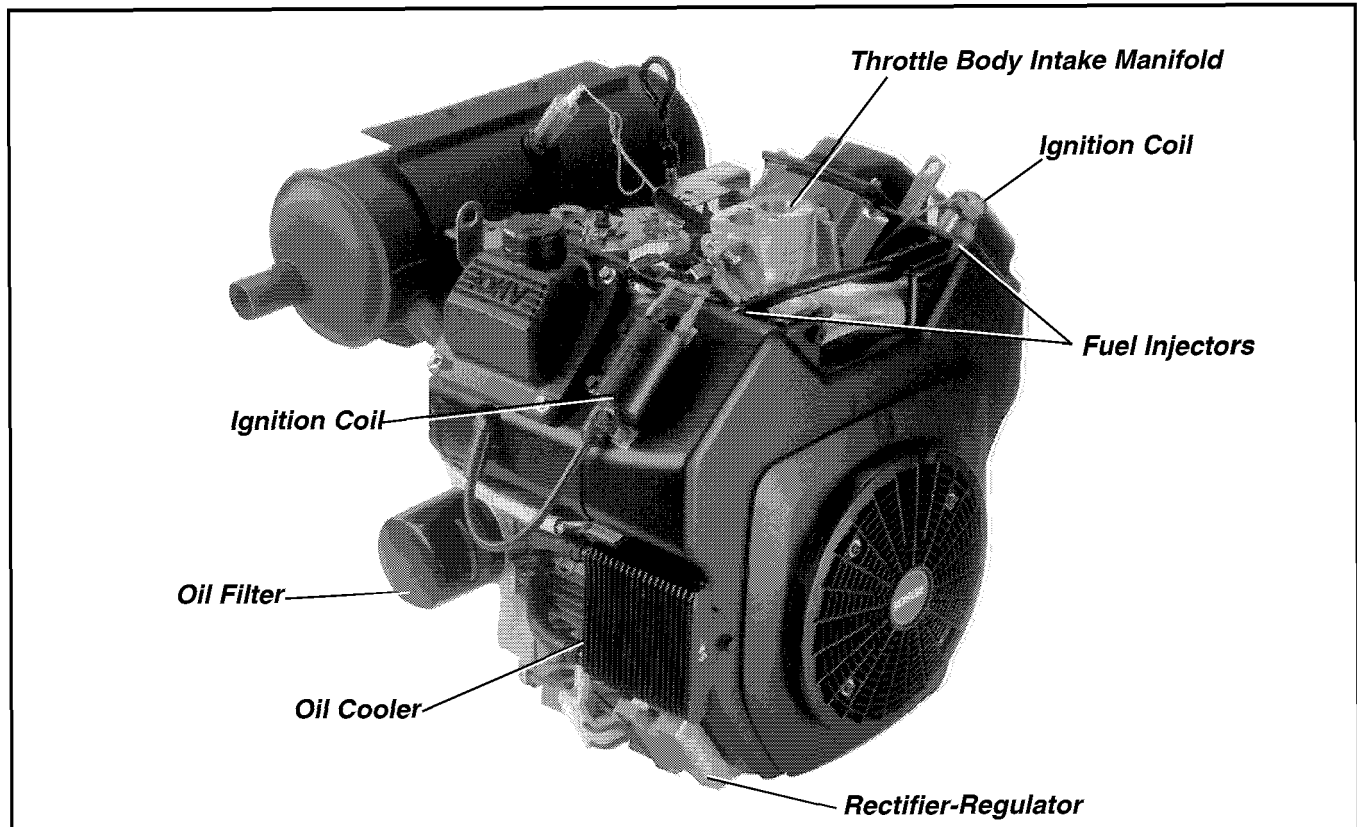


Figure 2. CH26 Command Horizontal Shaft Engine.



## Oil Recommendations

Using the proper type and weight of oil in the crankcase is extremely important. So is checking oil daily and changing oil regularly. Failure to use the correct oil, or using dirty oil, causes premature engine wear and failure.

### Oil Type

Use high quality detergent oil of **API (American Petroleum Institute) service class SG, SH, SJ or higher**. Select the viscosity based on the air temperature at the time of operation as shown in the following table.

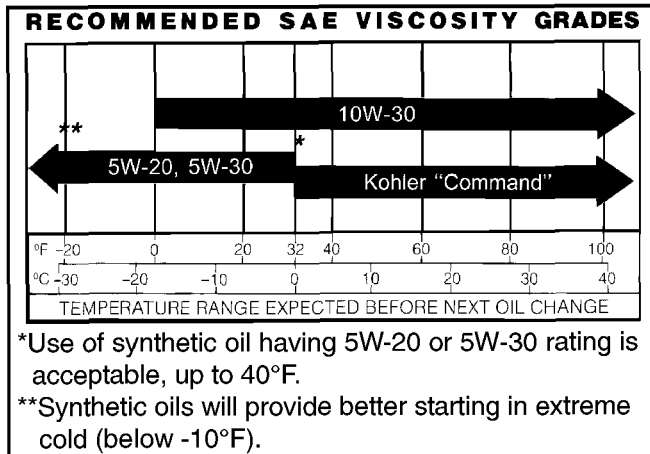


Figure 3. Viscosity Grades Table.

NOTE: Using other than service class SG, SH, SJ or higher oil or extending oil change intervals longer than recommended can cause engine damage.

A logo or symbol on oil containers identifies the API service class and SAE viscosity grade. See Figure 4.

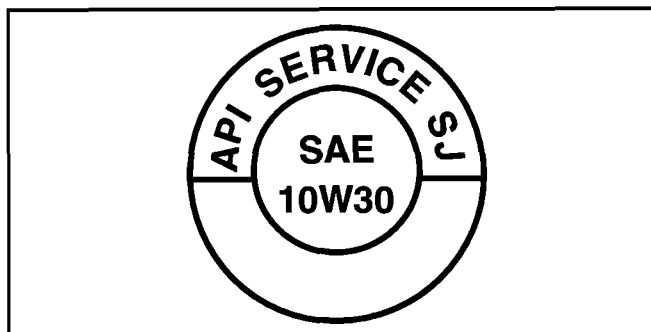


Figure 4. Oil Container Logo.

Refer to "Maintenance Instructions" beginning on page 8 for detailed oil check, oil change, and oil filter change procedures.

## Fuel Recommendations



### WARNING: Explosive Fuel!

Gasoline is extremely flammable and its vapors can explode if ignited. Store gasoline only in approved containers, in well ventilated, unoccupied buildings, away from sparks or flames. Do not fill the fuel tank while the engine is hot or running, since spilled fuel could ignite if it comes in contact with hot parts or sparks from ignition. Do not start the engine near spilled fuel. Never use gasoline as a cleaning agent.

### General Recommendations

Purchase gasoline in small quantities and store in clean, approved containers. A container with a capacity of 2 gallons or less with a pouring spout is recommended. Such a container is easier to handle and helps eliminate spillage during refueling.

Do not use gasoline left over from the previous season, to minimize gum deposits in fuel system and to insure easy starting.

Do not add oil to the gasoline.

Do not overfill the fuel tank. Leave room for the fuel to expand.

### Fuel Type

For best results use only clean, fresh, **unleaded** gasoline with a pump sticker octane rating of 87 or higher. In countries using the Research method, it should be 90 octane minimum.

Unleaded gasoline is recommended as it leaves less combustion chamber deposits and reduces harmful exhaust emissions. Leaded gasoline is not recommended and **must not** be used on CH26 engine, or on other models where exhaust emissions are regulated.

### Gasoline/Alcohol blends

Gasohol (up to 10% ethyl alcohol, 90% unleaded gasoline by volume) is approved as a fuel for Kohler engines. Other gasoline/alcohol blends are not approved.

### Gasoline/Ether blends

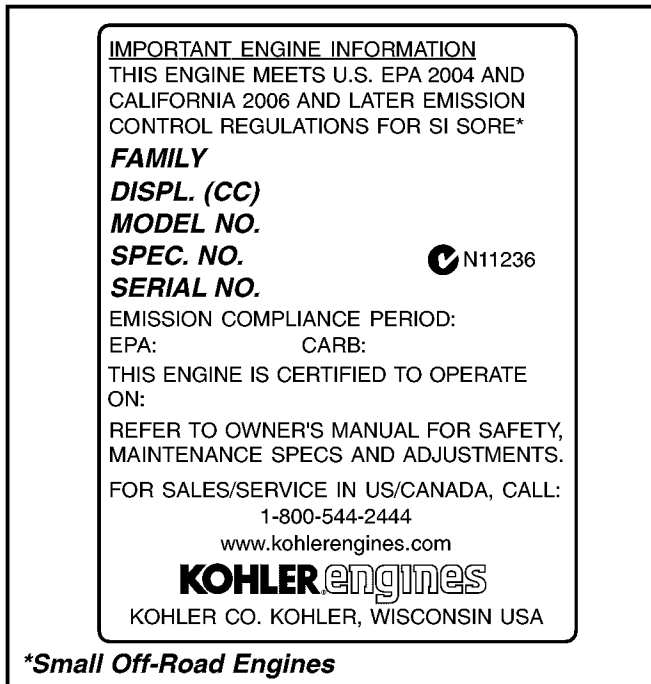
Methyl Tertiary Butyl Ether (MTBE) and unleaded gasoline blends (up to a maximum of 15% MTBE by volume) are approved as a fuel for Kohler engines. Other gasoline/ether blends are not approved.

## Engine Identification Numbers

When ordering parts, or in any communication involving an engine, always give the **Model, Specification, and Serial Numbers** of the engine.

The engine identification numbers appear on a decal affixed to the engine shrouding. Include letter suffixes, if there are any.

Record your engine identification numbers on the identification label below (Figure 5) for future reference.



**Figure 5. Engine Identification Label.**

The Emission Compliance Period referred to on the Emission Control or Air Index label indicates the number of operating hours for which the engine has been shown to meet Federal and CARB emission requirements. The following table provides the Engine Compliance Period (in hours) associated with the category descriptor found on the certification label.

### Emission Compliance Period (Hours)

EPA	Category C 250 hours	Category B 500 hours	Category A 1000 hours
CARB	Moderate 125 hours	Intermediate 250 hours	Extended 500 hours

Refer to certification label for engine displacement.

Exhaust Emission Control System for models CH18,20,22,23,25,730,740 is EM. Exhaust Emission Control System for model CH26 is EM, O2S, ECM, MFI.

## Model Designation

Model CH20S for example: C designates Command engine, H designates horizontal crankshaft, and 20 designates horsepower. Some model numbers (CH730) use the approximate displacement rather than horsepower. A letter suffix designates a specific version as follows:

Suffix	Designates
S	Electric Start
ST	Electric Start/Retractable Start
QS	Quiet Model/Electric Start
EP	Electric Plant
CS	Clutch Model/Electric Start

## Operating Instructions

Also read the operating instructions of the equipment this engine powers.

### Pre-Start Checklist

- Check oil level. Add oil if low. Do not overfill.
- Check fuel level. Add fuel if low.
- Check cooling air intake areas and external surfaces of engine. Make sure they are clean and unobstructed.
- Check that the air cleaner components and all shrouds, equipment covers, and guards are in place and securely fastened.
- Check that any clutches or transmissions are disengaged or placed in neutral. This is especially important on equipment with hydrostatic drive. The shift lever must be exactly in neutral to prevent resistance which could keep the engine from starting.



### **WARNING: Lethal Exhaust Gases!**

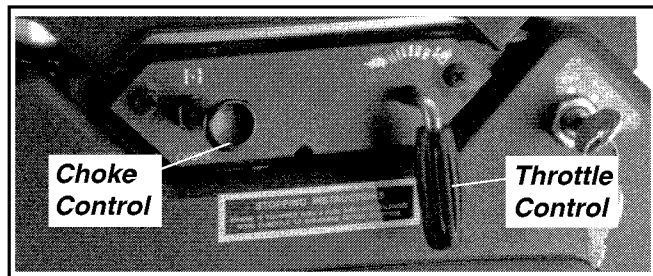
Engine exhaust gases contain poisonous carbon monoxide. Carbon monoxide is odorless, colorless, and can cause death if inhaled. Avoid inhaling exhaust fumes, and never run the engine in a closed building or confined area.

## Cold Weather Starting Hints

1. Be sure to use the proper oil for the temperature expected. See Figure 3 on page 5.
2. Disengage all possible external loads.
3. Be sure the battery is in good condition. A warm battery has much more starting capacity than a cold battery.
4. Use fresh winter grade fuel. NOTE: Winter grade gasoline has higher volatility to improve starting. Do not use gasoline left over from summer.

## Starting

1. Place the throttle control *midway* between the “*slow*” and “*fast*” positions. Place the choke control (non-EFI engines only) into the “*on*” position. See Figure 6.



**Figure 6. Optional Engine Mounted Throttle and Choke Controls (CH18-25,CH730,740).**

2. Start the engine by activating the key switch. Release the switch as soon as the engine starts.

**NOTE:** Do not crank the engine continuously for more than 10 seconds at a time. If the engine does not start, allow a 60 second cool down period between starting attempts. Failure to follow these guidelines can burn out, or permanently damage, the starter motor.

**NOTE:** Upon start-up, a metallic ticking may occur. This is caused by hydraulic lifter leakdown during storage. Run the engine for 5 minutes. The noise will normally cease in the first minute. If noise continues, run the engine at mid-throttle for 20 minutes. If noise persists, take the engine to your local authorized Kohler Engine Service Dealer.

**NOTE:** If the engine develops sufficient speed to disengage the starter but does not keep running (a false start), engine rotation must be allowed to come to a complete stop before attempting to restart the engine. If the starter is engaged while the flywheel is rotating, the starter pinion and flywheel ring gear may clash resulting in damage to the starter.

If the starter does not turn the engine over, shut off starter immediately. Do not make further attempts to start the engine until the condition is corrected. Do not jump start using another battery (refer to “Battery” on this page). See your Kohler Engine Service Dealer for service assistance.

## Carbureted Engines Only:

3. **For a Cold Engine** – Gradually return the choke control to the “*off*” position after the engine starts and warms up.

The engine/equipment may be operated during the warm-up period, but it may be necessary to leave the choke partially on until the engine warms up.

4. **For a Warm Engine** – Return choke to “*off*” position as soon as engine starts.

## Stopping

1. Remove the load by disengaging all PTO driven attachments.
2. **For Carbureted Engines Without A Shutdown Solenoid:** Move the throttle to the “*slow*” or “*low*” idle position. Allow the engine to run at idle for 30-60 seconds; then stop the engine.

**For Carbureted Engines Equipped With A Shutdown Solenoid:** Position the throttle control somewhere between half and full throttle; then stop the engine.

**For EFI Engines:** Move the throttle to the “*slow*” or “*idle*” position; turn key “*off*” to stop engine.

## Battery

A 12 volt battery is normally used. Refer to the operating instructions of the equipment this engine powers for specific battery requirements.

If the battery charge is not sufficient to crank the engine, recharge the battery (see page 13).

## Operating

### Angle of Operation

This engine will operate continuously at angles up to 25°. Check oil level to assure crankcase oil level is at the “F” mark on the dipstick.

Refer to the operating instructions of the equipment this engine powers. Because of equipment design or application, there may be more stringent restrictions regarding the angle of operation.

**NOTE:** Do not operate this engine continuously at angles exceeding 25° in any direction. Engine damage could result from insufficient lubrication.

### Cooling

NOTE: If debris builds up on the grass screen or other cooling air intake areas, stop the engine immediately and clean. Operating the engine with blocked or dirty air intake and cooling areas can cause extensive damage due to overheating.



#### **WARNING: Hot Parts!**

Engine components can get extremely hot from operation. To prevent severe burns, do not touch these areas while the engine is running, or immediately after it is turned off. Never operate the engine with heat shields or guards removed.

### Engine Speed

NOTE: Do not tamper with the governor setting to increase the maximum engine speed. Overspeed is hazardous and will void the engine warranty. The maximum allowable high idle speed for these engines is 3750 RPM, no load.

## Maintenance Instructions

**Maintenance, repair, or replacement of the emission control devices and systems, which are being done at the customer's expense, may be performed by any non-road engine repair establishment or individual. Warranty repairs must be performed by an authorized Kohler service outlet.**



#### **WARNING: Accidental Starts!**

**Disabling engine. Accidental starting can cause severe injury or death.** Before working on the engine or equipment, disable the engine as follows: 1) Disconnect the spark plug lead(s). 2) Disconnect negative (-) battery cable from battery.

## Maintenance Schedule

These required maintenance procedures should be performed at the frequency stated in the table. They should also be included as part of any seasonal tune-up.

<b>Frequency</b>	<b>Maintenance Required</b>
<b>Daily or Before Starting Engine</b>	<ul style="list-style-type: none"><li>• Fill fuel tank.</li><li>• Check oil level.</li><li>• Check air cleaner for dirty<sup>1</sup>, loose, or damaged parts.</li><li>• Check air intake and cooling areas, clean as necessary<sup>1</sup>.</li></ul>
<b>Every 25 Hours</b>	<ul style="list-style-type: none"><li>• Service precleaner element<sup>1</sup>.</li></ul>
<b>Every 100 Hours</b>	<ul style="list-style-type: none"><li>• Replace air cleaner element<sup>1</sup>.</li><li>• Change oil. (More frequently under severe conditions.)</li><li>• Remove cooling shrouds and clean cooling areas<sup>1,3</sup>.</li><li>• Check oil cooler fins, clean as necessary (if equipped).</li></ul>
<b>Every 200 Hours</b>	<ul style="list-style-type: none"><li>• Check spark plug condition and gap.</li><li>• Change oil filter.</li></ul>
<b>Every 250 Hours</b>	<ul style="list-style-type: none"><li>• Replace heavy-duty air cleaner element and check inner element<sup>1</sup>.</li></ul>
<b>Annually or Every 500 Hours</b>	<ul style="list-style-type: none"><li>• Have bendix starter drive serviced<sup>2</sup>.</li><li>• Have solenoid shift starter disassembled and cleaned<sup>2</sup>.</li></ul>
<b>Every 500 Hours</b>	<ul style="list-style-type: none"><li>• Have crankshaft spline lubricated<sup>2</sup>.</li></ul>
<b>Every 1500 Hours</b>	<ul style="list-style-type: none"><li>• Replace fuel filter<sup>1</sup> (EFI engines).</li></ul>

<sup>1</sup>Perform these maintenance procedures more frequently under extremely dusty, dirty conditions.

<sup>2</sup>Have a Kohler Engine Service Dealer perform this service.

<sup>3</sup>Cleanout Kits 25 755 20-S (black) or 25 755 21-S (gold) allow cooling areas to be cleaned without removing shrouds.

## Check Oil Level

The importance of checking and maintaining the proper oil level in the crankcase cannot be overemphasized. Check oil **BEFORE EACH USE** as follows:

1. Make sure the engine is stopped, level, and is cool so the oil has had time to drain into the sump.
2. To keep dirt, debris, etc., out of the engine, clean the area around the dipstick before removing it.
3. Remove the dipstick; wipe oil off. Reinsert the dipstick into the tube and press all the way down.
4. Remove the dipstick and check the oil level.

The oil level should be up to, but not over, the "F" mark on the dipstick. See Figure 7.

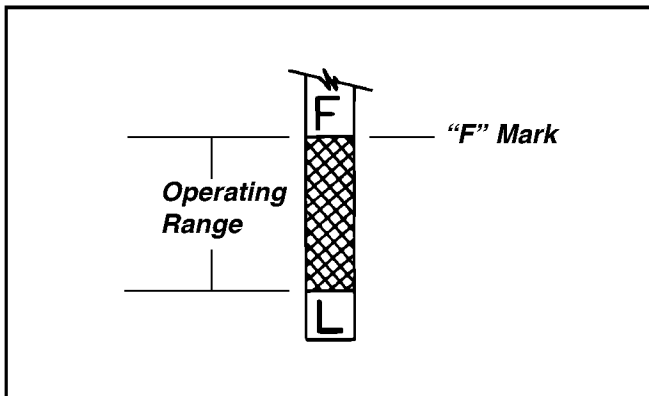


Figure 7. Oil Level Dipstick.

5. If the level is low, add oil of the proper type, up to the "F" mark on the dipstick. (Refer to "Oil Type" on page 5.) Always check the level with the dipstick before adding more oil.

NOTE: To prevent extensive engine wear or damage, always maintain the proper oil level in the crankcase. Never operate the engine with the oil level below the "L" mark or over the "F" mark on the dipstick.

## Oil Sentry™

Some engines are equipped with an optional Oil Sentry™ oil pressure switch. If the oil pressure decreases below an acceptable level, the Oil Sentry™ will either shut off the engine or activate a warning signal, depending on the application.

NOTE: Make sure the oil level is checked **BEFORE EACH USE** and is maintained up to the "F" mark on the dipstick. This includes engines equipped with Oil Sentry™.

## Change Oil and Filter, Service Oil Cooler

### Change Oil

Change oil after every **100 hours** of operation (more frequently under severe conditions). Refill with service class SG, SH, SJ or higher oil as specified in the "Viscosity Grades" table (Figure 3) on page 5.

Change the oil while the engine is still warm. The oil will flow more freely and carry away more impurities. Make sure the engine is level when filling, checking, and changing the oil.

Change the oil as follows (see Figures 8 and 9):

1. To keep dirt, debris, etc., out of the engine, clean the area around the oil fill cap/dipstick before removing it.
2. Remove one of the oil drain plugs, oil fill cap, and dipstick. Be sure to allow ample time for complete drainage.
3. Reinstall the drain plug. Make sure it is tightened to **13.6 N·m (10 ft. lb.)** torque.
4. Fill the crankcase, with new oil of the proper type, to the "F" mark on the dipstick. Refer to "Oil Type" on page 5. Always check the level with the dipstick before adding more oil.
5. Reinstall the oil fill cap and tighten securely. Reinstall dipstick.

NOTE: To prevent extensive engine wear or damage, always maintain the proper oil level in the crankcase. Never operate the engine with the oil level below the "L" mark or over the "F" mark on the dipstick.

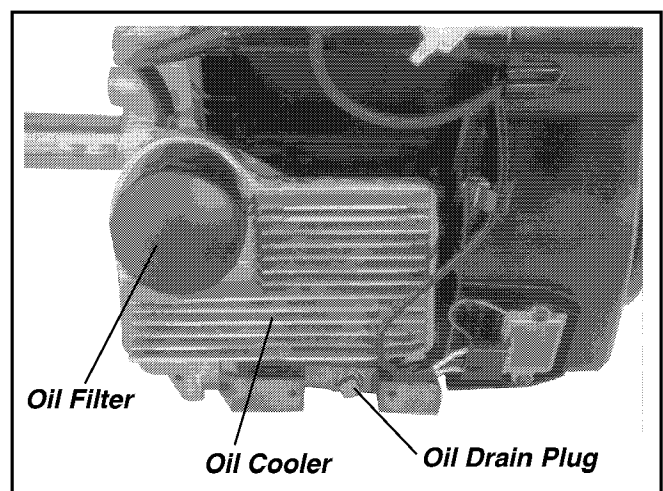
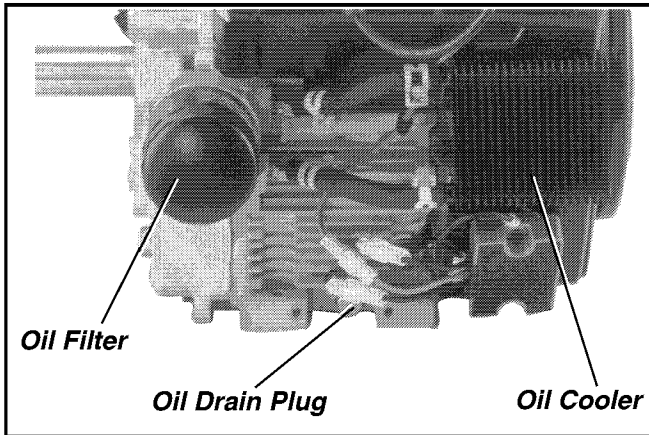


Figure 8. Oil Drain Plugs, Oil Filter, and Oil Cooler (CH25 shown).



**Figure 9. Oil Drain Plugs, Oil Filter, and Oil Cooler (CH26 shown).**

### **Change Oil Filter**

Replace the oil filter **at least every other oil change (every 200 hours of operation)**. Always use a genuine Kohler oil filter, Part No. 12 050 01-S.

Replace the oil filter as follows:

1. Drain the oil from the engine crankcase.
2. Allow the oil filter to drain.
3. Before removing the oil filter, clean the area around the oil filter to keep dirt and debris out of the engine. Remove the old filter. Wipe off the surface where the oil filter mounts.
4. Place a new replacement filter in a shallow pan with the open end up. Pour new oil, of the proper type, in through the threaded center hole. Stop pouring when the oil reaches the bottom of the threads. Allow a minute or two for the oil to be absorbed by the filter material.
5. Put a drop of oil on your fingertip and wipe it on the rubber gasket.
6. Install the replacement oil filter to the filter adapter or oil cooler. Turn the oil filter clockwise until the rubber gasket contacts the filter adapter or oil cooler, then tighten the filter an additional **2/3 to 1 turn**.
7. Reinstall the drain plug. Make sure it is tightened to **13.6 N·m (10 ft. lb.)** torque.
8. Fill the crankcase with new oil of the proper type to the "F" mark on the dipstick.
9. Start the engine and check for oil leaks. Correct any leaks before placing the engine into service. Check oil level to be sure it is up to but not over the "F" mark.

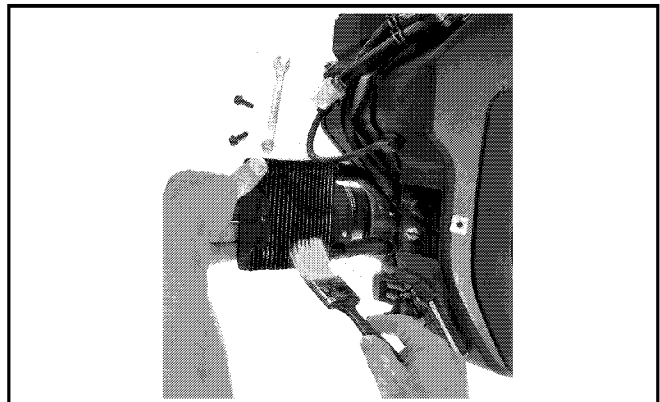
### **Service Oil Cooler**

Some engines are equipped with an oil cooler. One style of oil cooler mounts on the engine crankcase and has the oil filter on it (See Figure 8). The other style of oil cooler is mounted on the blower housing (See Figure 9), separate from the oil filter.

Inspect and clean the oil cooler **every 100 hours of operation** (more frequently under severe conditions). Oil cooler must be kept free of debris.

To service the crankcase mounted oil cooler clean off the outside fins with a brush or with compressed air.

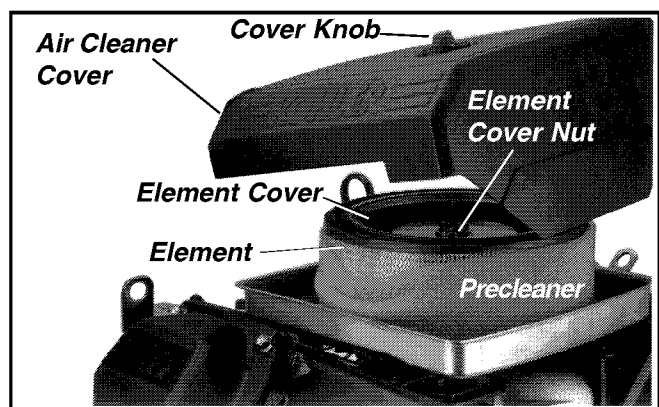
To service the blower housing mounted oil cooler, clean the outside of fins with a brush. Remove the two screws holding the cooler unit to the blower housing. Tilt the cooler downward as shown in Figure 10. Clean the inside of cooler with a brush as shown in Figure 10 or with compressed air. After cleaning, reinstall oil cooler to blower housing with two mounting screws.



**Figure 10.**

### **Service Precleaner and Air Cleaner Element**

This engine is equipped with a replaceable, high density paper air cleaner element. Most engines are also equipped with an oiled, foam precleaner which surrounds the paper element. See Figure 11.



**Figure 11. Air Cleaner System Components.**

---

Check the air cleaner **daily or before starting the engine**. Check for a buildup of dirt and debris around the air cleaner system. Keep this area clean. Also check for loose or damaged components. Replace all bent or damaged air cleaner components.

NOTE: Operating the engine with loose or damaged air cleaner components could allow unfiltered air into the engine causing premature wear and failure.

### **Service Precleaner**

If so equipped, wash and reoil the precleaner every **25 hours** of operation (more often under extremely dusty or dirty conditions).

1. Loosen the cover retaining knob and remove the cover.
2. Remove the precleaner from the paper element.
3. Wash the precleaner in warm water with detergent. Rinse the precleaner thoroughly until all traces of detergent are eliminated. Squeeze out excess water (do not wring). Allow the precleaner to air dry.
4. Saturate the precleaner with new engine oil. Squeeze out all excess oil.
5. Reinstall the precleaner over the paper element.
6. Reinstall the air cleaner cover. Secure cover with the cover retaining knob.
7. When precleaner replacement is necessary, order genuine Kohler parts.

<b>24 083 02-S 61 mm deep x 173 mm O.D.</b>
---------------------------------------------

<b>24 083 05-S 71 mm deep x 173 mm O.D.</b>
---------------------------------------------

### **Service Paper Element**

Every **100 hours** of operation (more often under extremely dusty or dirty conditions) replace the paper element.

1. Loosen the cover retaining knob and remove the cover.
2. Remove the element cover nut, element cover, and paper element with precleaner.
3. Remove the precleaner (if so equipped) from the paper element. Service the precleaner as described above.

4. Do not wash the paper element or **use pressurized air**, as this will damage the element. Replace a dirty, bent, or damaged element with a genuine Kohler element. Handle new elements carefully; do not use if the sealing surfaces are bent or damaged.

5. When servicing the air cleaner, check the air cleaner base. Make sure it is secured and not bent or damaged. Also, check the element cover for damage or improper fit. Replace all damaged air cleaner components.

NOTE: If any loose dirt or debris fell on the air cleaner base when the element was removed, carefully remove it and wipe the base clean. Be careful that none of it drops into the intake throat. Check the condition of the rubber seal on the air cleaner stud. If the condition is questionable in any way, replace it with the new seal packaged with the replacement element.

6. Reinstall the paper element, precleaner, element cover, element cover nut, and air cleaner cover. Secure cover with the cover retaining knob.
7. When element replacement is necessary, order genuine Kohler parts.

<b>47 083 03-S 65 mm deep x 178 mm O.D.</b>
---------------------------------------------

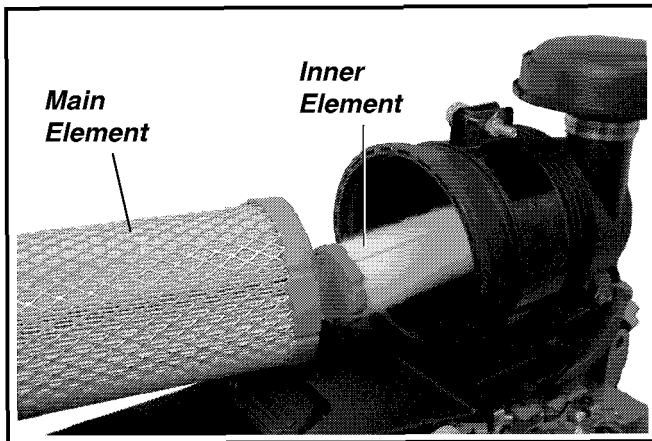
<b>24 083 03-S 74 mm deep x 178 mm O.D.</b>
---------------------------------------------

### **Heavy-Duty Air Cleaner**

#### **To Service**

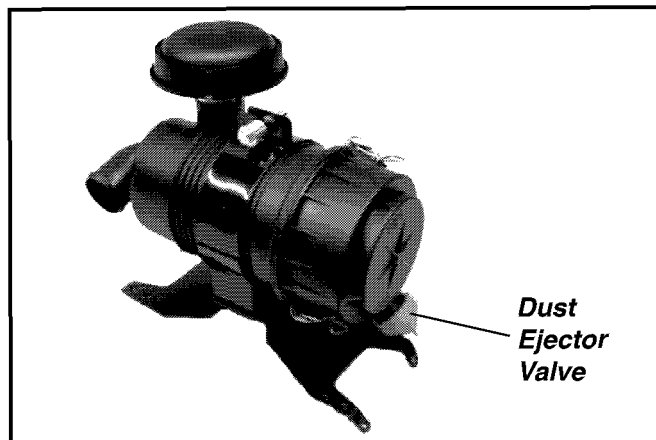
Every **250 hours** of operation (more often under extremely dusty or dirty conditions), replace the paper element and check inner element. Follow these steps.

1. Unhook the two retaining clips and remove the end cap from the air cleaner housing.
2. Pull the air cleaner element out of the housing. See Figure 12.



**Figure 12. Removing Elements.**

3. After the main element is removed, check the condition of the inner element. It should be replaced whenever it appears dirty, typically every other time the main element is replaced. Clean the area around the base of the inner element before removing it, so dirt does not get into the engine.
4. **Do not** wash the paper element and inner element or use pressurized air, this will damage the elements. Replace dirty, bent or damaged elements with new genuine Kohler elements as required. Handle new elements carefully; do not use if the sealing surfaces are bent or damaged.
5. Check all parts for wear, cracks, or damage. Replace any damaged components.
6. Install the new inner element, Kohler Part No. **25 083 04-S** followed by the outer element, Kohler Part No. **25 083 01-S**. Slide each fully into place in the air cleaner housing.
7. Reinstall the end cap so the dust ejector valve is down and secure with the two retaining clips. See Figure 13.



**Figure 13. Heavy-Duty Air Cleaner Assembly.**

### **Clean Air Intake/Cooling Areas**

To ensure proper cooling, make sure the grass screen, cooling fins, and other external surfaces of the engine are kept clean **at all times**.

Every **100 hours** of operation (more often under extremely dusty, dirty conditions), remove the blower housing\* and other cooling shrouds. Clean the cooling fins and external surfaces as necessary. Make sure the cooling shrouds are reinstalled.

**NOTE:** Operating the engine with a blocked grass screen, dirty or plugged cooling fins, and/or cooling shrouds removed, will cause engine damage due to overheating.

\*Cleanout kits 25 755 20-S (black) or 25 755 21-S (gold) allow inspection and cleanout of the cooling fins, without removing the blower housing.

### **Ignition System**

**Carbureted Engines** - Use an electronic Capacitive Discharge (CD) ignition system. Other than periodically checking/replacing the spark plugs, no maintenance, timing, or adjustments are necessary or possible with this system.

**EFI Engines** - Incorporate a computer-controlled battery ignition system with individual coils. Other than periodically checking/replacing the spark plugs, no maintenance, timing, or adjustments are necessary or possible with this system.

### **Check Spark Plugs**

Every **200 hours** of operation, remove the spark plugs, check condition, and reset the gap or replace with new plugs as necessary. The standard spark plug is a Champion® RC12YC (Kohler Part No. 12 132 02-S). A high-performance spark plug, Champion® Premium Gold 2071 (used on Pro Series engines, Kohler Part No. 12 132 06-S) is also available. Equivalent alternate brand plugs can also be used.

1. Before removing the spark plug, clean the area around the base of the plug to keep dirt and debris out of the engine.
2. Remove the plug and check its condition. Replace the plug if worn or reuse is questionable.

**NOTE:** Do not clean the spark plug in a machine using abrasive grit. Some grit could remain in the spark plug and enter the engine causing extensive wear and damage.



3. Check the gap using a wire feeler gauge. Adjust the gap to **0.76 mm (0.030 in.)** by carefully bending the ground electrode. See Figure 14.

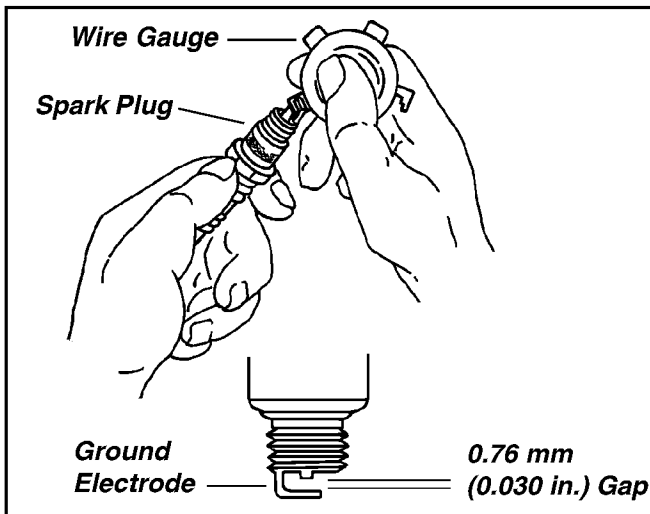


Figure 14. Servicing Spark Plug.

4. Reinstall the spark plug into the cylinder head. Torque the spark plug to **24.4-29.8 N·m (18-22 ft. lb.)**.

### Battery Charging



#### **WARNING: Explosive Gas!**

Batteries produce explosive hydrogen gas while being charged. To prevent a fire or explosion, charge batteries only in well ventilated areas. Keep sparks, open flames, and other sources of ignition away from the battery at all times. Keep batteries out of the reach of children. Remove all jewelry when servicing batteries.

Before disconnecting the negative (-) ground cable, make sure all switches are OFF. If ON, a spark will occur at the ground cable terminal which could cause an explosion if hydrogen gas or gasoline vapors are present.

NOTE: Do not apply 12 volt DC to kill terminal of ignition module.

### Fuel System



#### **WARNING: Fuel System Under Pressure!**

The EFI fuel system operates under high pressure, and the fuel filter and fuel line used must be approved system components only. Use of substitute parts can result in system failure, gasoline leakage and possible explosion.

### Fuel Filter

**Carbureted Engines:** Some engines are equipped with an in-line fuel filter. Periodically inspect the filter and replace when dirty. *Always use genuine Kohler parts.*

**EFI Engines:** A special, high volume, high pressure filter with greater filtration capabilities and internal surface area is used. See Figure 15.

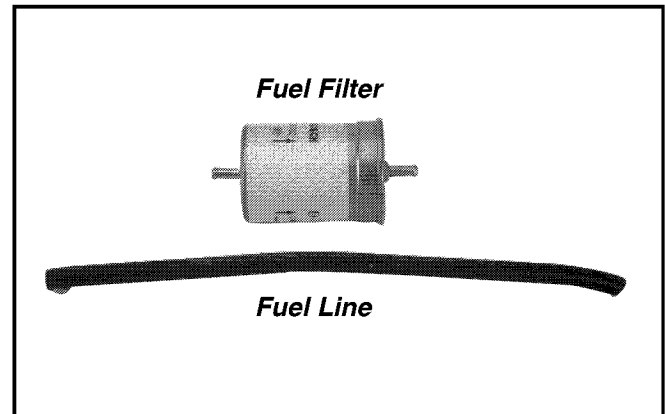


Figure 15. EFI Fuel Filter and Line.

Replacement is recommended **every 1500 hours**, or more frequently under extremely dusty or dirty conditions. When replacement is necessary, always use genuine Kohler parts.

### Fuel Line

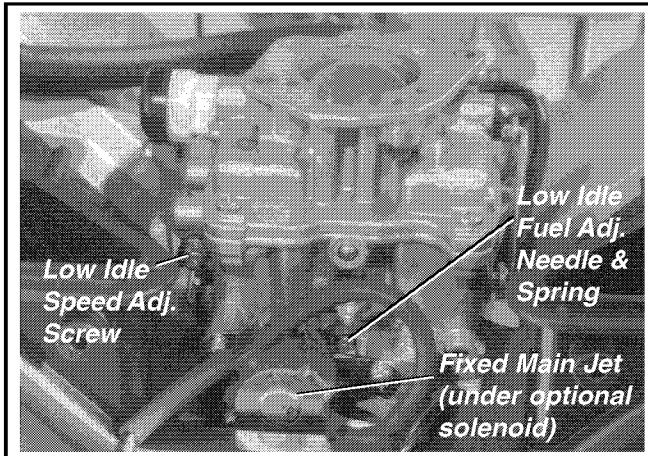
**EFI Engines:** A special fuel line, capable of withstanding the high pressure of the EFI fuel system, is used (must meet SAE R9 specifications). See Figure 15. If fuel line must be replaced, see your Kohler Engine Service Dealer.

### Carburetor Troubleshooting and Adjustments

NOTE: Carburetor adjustments should be made only after the engine has warmed up.

The carburetor is designed to deliver the correct fuel-to-air mixture to the engine under all operating conditions. To comply with current emission regulations, the fuel mixture settings are made at the factory and cannot be adjusted.

NOTE: To ensure correct engine operating at altitudes above 1525 meters (5000ft.), it may be necessary to have an authorized Kohler dealer install a special high-altitude jet kit in the carburetor. If a high-altitude kit has been installed, the engine must be reconverted to the original jet size, before it is operated at lower altitudes, or overheating and engine damage can result.



**Figure 16. Carburetor (CH18-25,CH730,740).**

### **Troubleshooting**

If engine troubles are experienced that appear to be fuel system related, check the following areas before adjusting the carburetor.

- Make sure the fuel tank is filled with clean, fresh gasoline.
- Make sure the fuel tank cap vent is not blocked and that it is operating properly.
- If the fuel tank is equipped with a shut-off valve, make sure it is open.
- If the engine is equipped with an in-line fuel filter, make sure it is clean and unobstructed. Replace the filter if necessary.
- Make sure fuel is reaching the carburetor. This includes checking the fuel lines and fuel pump for restrictions or faulty components, replace as necessary.
- Make sure the air cleaner element is clean and all air cleaner element components are fastened securely.

If, after checking the items listed above, the engine is hard to start, runs roughly, or stalls at low idle speed, it may be necessary to adjust or service the carburetor.

### **Adjust Carburetor**

There are no accessible mixture adjustment screws on the carburetor. The only setting which can be changed is the low idle speed.

1. Start the engine and run at half throttle for 5 to 10 minutes to warm up. The engine must be warm before making final settings (steps 2 and 3).

2. **Low Idle Speed Setting:** Place the throttle control into the “idle” or “slow” position. Set the low idle speed to **1200 RPM\*** ( $\pm 75$  RPM) by turning the low idle speed adjusting screw *in* or *out*. Check the speed using a tachometer.

\*NOTE: The actual low idle speed depends on the application – refer to equipment manufacturers recommendations. The standard low idle speed is 1200 RPM.

3. If proper operation is not restored after adjusting the low idle speed, carburetor servicing by an authorized Kohler Engine Service Dealer may be required.

### **Electronic Fuel Injection (EFI) System**

The EFI system is a complete, electronically-controlled fuel management system, designed to deliver a precisely controlled fuel flow under all operating conditions. The electronic control unit (ECU), the “brain” of the system, automatically adjusts fuel delivery and ignition timing based upon load, speed, operating temperature, and exhaust emission levels. The low idle speed is the only manual adjustment possible.

The ECU continuously monitors operation of the EFI system. If it detects a problem or fault within the system, it will illuminate the malfunction indicator light (MIL), which is mounted in view of the operator. This is a signal that normal, programmed operation has been affected, and service by an authorized Kohler Engine Dealer is required.

NOTE: The EFI system requires a rather complex wiring harness to carry the electrical signals between the sensors and the ECU. **Do not** spray water at the wiring harness or any of the electrical components, especially the ECU, as it could cause malfunction, damage, or failure.

### **Troubleshooting**

If the MIL comes on, or the engine becomes hard to start, runs roughly, or stalls at low idle speed, initial checks should be made in the following areas:

- Make sure the fuel tank is filled with clean, fresh gasoline, and shut-off valve (if so equipped) is opened completely.
- Make sure fuel tank vent cap is not blocked and it is operating properly.
- Make sure the air cleaner element and precleaner are clean and all components are properly secured. Clean or replace as necessary.

- Make sure the proper fuel filter is being used, and it is clean and unobstructed. Replace filter **only** with genuine Kohler parts.
- Make sure all connections to sensors, ECU, and fuel injectors are properly secured.
- Make sure a good 12 volt battery is being used and is fully charged.

If adjustment is to be made, the engine must be at operating temperature, air cleaner in place, and check engine light must be off (no fault codes present).

1. Start the engine and run at half throttle for 5 to 10 minutes to warm up.
2. Place the throttle control into the “idle” or “slow” position.
3. Turn the low idle speed adjusting screw in or out and check RPM with a tachometer. See Figure 17.

If these checks do not correct the problem, or the MIL remains on, further diagnosis and servicing by an authorized Kohler Engine Dealer is necessary.

### Adjustment – EFI Throttle Body

**Low Idle Speed (RPM)** is the only adjustment that can be made. All other fuel calibrations are permanently preset and controlled by the ECU. The standard low idle speed is **1500 RPM\*** (± 75 RPM).

\*NOTE: The actual low idle speed depends on the application -- refer to equipment manufacturer's recommendations.

When an EFI engine is started cold, the ECU will be using internal programming for cold running, and the idle speed may vary from the manual setting. Do not attempt to perform any readjustment during this “warm-up” period.

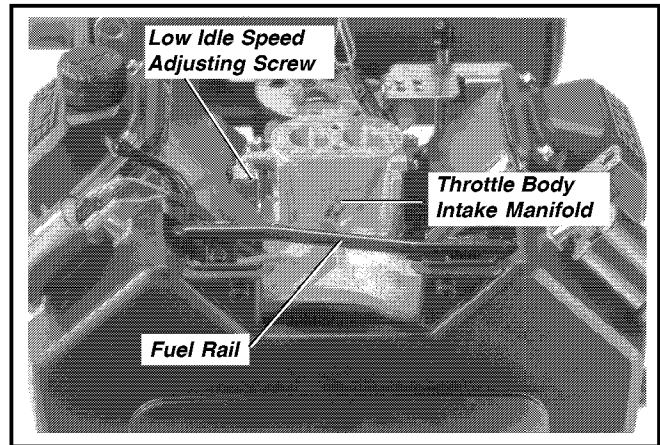


Figure 17. EFI Throttle Body Manifold.

### Troubleshooting

When troubles occur, be sure to check the simple causes which, at first, may seem too obvious to be considered. For example, a starting problem could be caused by an empty fuel tank. Some common causes of engine troubles are listed in the following table.

Do not attempt to service or replace major engine components, or any items that require special timing or adjustment procedures. Have your Kohler Engine Service Dealer do this work.

Possible Cause Problem	No Fuel	Improper Fuel	Dirt In Fuel Line/System	Dirty Grass Screen	Incorrect Oil Level	Engine Overloaded	Dirty Air Cleaner	Faulty Spark Plug
Will Not Start	•	•	•		•	•	•	•
Hard Starting		•	•		•	•	•	•
Stops Suddenly	•		•	•	•	•	•	
Lacks Power		•	•	•	•	•	•	•
Operates Erratically		•	•	•	•	•	•	•
Knocks or Pings		•		•	•	•		•
Skips or Misfires		•	•	•			•	•
Backfires			•			•	•	•
Overheats			•	•	•	•	•	
High Fuel Consumption						•	•	•

---

## Storage

If the engine will be out of service for two months or more, use the following storage procedure:

1. Clean the exterior surfaces of the engine. On EFI engines, avoid spraying water at the wiring harness or any of the electrical components.
2. Change the oil and filter while the engine is still warm from operation. See "Change Oil and Oil Filter" on page 9.
3. The fuel system must be completely emptied, or the gasoline must be treated with a stabilizer to prevent deterioration. If you choose to use a stabilizer, follow the manufacturers recommendations, and add the correct amount for the capacity of the fuel system. Fill the fuel tank with clean, fresh gasoline. Run the engine for 2-3 minutes to get stabilized fuel into the rest of the system. Close fuel shut-off valve when unit is being stored or transported.

To empty the system, run the engine until the tank and system are empty.

4. Remove the spark plugs. Add one tablespoon of engine oil into each spark plug hole. Install the plugs, but do not connect the plug leads. Crank the engine two or three revolutions.
5. Store the engine in a clean, dry place.

## Specifications

Model:	CH18,20,22	CH25,26,730,740
Bore:	77 (3.03)*	83 (3.27)
Stroke:	67 (2.64)	67 (2.64)
Displacement:	624 (38.1)*	725 (44.0)
Power (@3600 RPM):	13.4 (18*)/14.9 (20*)/16.4 (22*)	18.4 (25*)/19.4 (26) 18.6 (25*)/20.1 (27)
Max. Torque (@ RPM):	41 (30) @2500 44 (32) @2500 45 (33) @2500	54 (39.5) @2200 56.4 (41.6) @2200 52 (38) @2800 54 (40) @2800
Compression Ratio:	8.5:1	9.0:1
Weight:	41 (90)	43 (94)
Oil Capacity (w/filter):	2 (2.1)	2 (2.1)
Lubrication:	Full Pressure w/full Flow Filter	

Exhaust Emission Control System for models CH18,20,22,23,25,730,740 is EM.

Exhaust Emission Control System for model CH26 is EM, O2S, ECM, MFI.

\*Horsepower ratings are established in accordance with Society of Automotive Engineers – Small Engine Test Code –J1995 GROSS. Kohler Co. reserves the right to change product specifications, design, and standard equipment without notice and without incurring obligation.

\*CH22 or CH23 engines with Spec. Numbers of 765xx have bore size of 80 mm (3.15 in.) and displacement of 674 cm<sup>3</sup> (41.1 in<sup>3</sup>).

## Parts Ordering

The engine Specification, Model, and Serial Numbers are required when ordering replacement parts from your Kohler Engine Service Dealer. These numbers are found on the identification plate which is affixed to the engine shrouding. Include letter suffixes if there are any. See "Engine Identification Numbers" on page 6.

*Always insist on genuine Kohler parts.* All genuine Kohler parts meet strict standards for fit, reliability, and performance.

## Major Repair

Major repair information is available in Kohler Engine Service Manuals. However, major repair generally requires the attention of a trained mechanic and the use of special tools and equipment. Your Kohler Engine Service Dealer has the facilities, training, and genuine Kohler replacement parts necessary to perform this service. For Sales & Service assistance call 1-800-544-2444 (U.S. & Canada) or contact your Kohler Engine Dealer or Service Distributor, they're in the Yellow Pages under Engines-Gasoline.

## **LIMITED 2 YEAR COMMAND ENGINE WARRANTY**

We warrant to the original consumer that each new COMMAND engine sold by us will be free from manufacturing defects in materials or workmanship in normal service for a period of two (2) years from date of purchase, provided it is operated and maintained in accordance with Kohler Co.'s instructions and manuals.

Our obligation under this warranty is expressly limited, at our option, to the replacement or repair at Kohler Co., Kohler, Wisconsin 53044, or at a service facility designated by us of such parts as inspection shall disclose to have been defective.

### **EXCLUSIONS:**

Mufflers on engines used commercially (non-residential) are warranted for one (1) year from date of purchase, except catalytic mufflers, which are warranted for two (2) years.

This warranty does not apply to defects caused by casualty or unreasonable use, including faulty repairs by others and failure to provide reasonable and necessary maintenance.

The following items are not covered by this warranty:

Engine accessories such as fuel tanks, clutches, transmissions, power-drive assemblies, and batteries, unless supplied or installed by Kohler Co. These are subject to the warranties, if any, of their manufacturers.

WE SHALL NOT BE LIABLE FOR SPECIAL, INDIRECT, INCIDENTAL, OR CONSEQUENTIAL DAMAGES OF ANY KIND, including but not limited to labor costs or transportation charges in connection with the repair or replacement of defective parts.

ANY IMPLIED OR STATUTORY WARRANTIES, INCLUDING WARRANTY OF MERCHANTABILITY OR FITNESS FOR A PARTICULAR PURPOSE, ARE EXPRESSLY LIMITED TO THE DURATION OF THIS WRITTEN WARRANTY. We make no other express warranty, nor is any one authorized to make any in our behalf.

Some states do not allow limitations on how long an implied warranty lasts, or the exclusion or limitation of incidental or consequential damages, so the above limitation or exclusion may not apply to you.

This warranty gives you specific legal rights, and you may also have other rights which vary from state to state.

### **TO OBTAIN WARRANTY SERVICE:**

Purchaser must bring the engine to an authorized Kohler service facility. For the facility nearest you, consult your Yellow Pages or write Kohler Co., Attn: Engine Warranty Service Dept., Kohler, Wisconsin, 53044.

ENGINE DIVISION, KOHLER CO., KOHLER, WISCONSIN 53044

## **KOHLER CO. FEDERAL AND CALIFORNIA EMISSION CONTROL SYSTEMS LIMITED WARRANTY SMALL OFF-ROAD ENGINES**

The U.S. Environmental Protection Agency (EPA), the California Air Resources Board (CARB), and Kohler Co. are pleased to explain the Federal and California Emission Control Systems Warranty on your small off-road equipment engine. For California, engines produced in 1995 and later must be designed, built and equipped to meet the state's stringent anti-smog standards. In other states, 1997 and later model year engines must be designed, built and equipped, to meet the U.S. EPA regulations for small non-road engines. The engine must be free from defects in materials and workmanship which cause it to fail to conform with U.S. EPA standards for the first two years of engine use from the date of sale to the ultimate purchaser. Kohler Co. must warrant the emission control system on the engine for the period of time listed above, provided there has been no abuse, neglect or improper maintenance.

The emission control system may include parts such as the carburetor or fuel injection system, the ignition system, and catalytic converter. Also included are the hoses, belts and connectors and other emission related assemblies.

Where a warrantable condition exists, Kohler Co. will repair the engine at no cost, including diagnosis (if the diagnostic work is performed at an authorized dealer), parts and labor.

### **MANUFACTURER'S WARRANTY COVERAGE**

Engines produced in 1995 or later are warranted for two years in California. In other states, 1997 and later model year engines are warranted for two years. If any emission related part on the engine is defective, the part will be repaired or replaced by Kohler Co. free of charge.

### **OWNER'S WARRANTY RESPONSIBILITIES**

- (a) The engine owner is responsible for the performance of the required maintenance listed in the owner's manual. Kohler Co. recommends that you retain all receipts covering maintenance on the engine, but Kohler Co. cannot deny warranty solely for the lack of receipts or for your failure to assure that all scheduled maintenance was performed.
- (b) Be aware, however, that Kohler Co. may deny warranty coverage if the engine or a part has failed due to abuse, neglect, improper maintenance or unapproved modifications.

*Continued on next page.*

- (c) For warranty repairs, the engine must be presented to a Kohler Co. service center as soon as a problem exists. Call 1-800-544-2444 or access our website at: [www.kohlerengines.com](http://www.kohlerengines.com), for the names of the nearest service centers. The warranty repairs should be completed in a reasonable amount of time, not to exceed 30 days.

If you have any questions regarding warranty rights and responsibilities, you should contact Kohler Co. at 1-920-457-4441 and ask for an Engine Service representative.

#### **COVERAGE**

Kohler Co. warrants to the ultimate purchaser and each subsequent purchaser that the engine will be designed, built and equipped, at the time of sale, to meet all applicable regulations. Kohler Co. also warrants to the initial purchaser and each subsequent purchaser, that the engine is free from defects in materials and workmanship which cause the engine to fail to conform with applicable regulations for a period of two years.

Engines produced in 1995 or later are warranted for two years in California. For 1997 and later model years, EPA requires manufacturers to warrant engines for two years in all other states. These warranty periods will begin on the date the engine is purchased by the initial purchaser. If any emission related part on the engine is defective, the part will be replaced by Kohler Co. at no cost to the owner. Kohler Co. is liable for damages to other engine components caused by the failure of a warranted part still under warranty.

Kohler Co. shall remedy warranty defects at any authorized Kohler Co. engine dealer or warranty station. Warranty repair work done at an authorized dealer or warranty station shall be free of charge to the owner if such work determines that a warranted part is defective.

Listed below are the parts covered by the Federal and California Emission Control Systems Warranty. Some parts listed below may require scheduled maintenance and are warranted up to the first scheduled replacement point for that part. The warranted parts are:

- Carburetor assembly
- Throttle body (EFI Systems)
- Catalytic muffler (if equipped)
- Fuel metering valve (if equipped)
- Crankcase breather
- Fuel pressure regulator (EFI Systems)
- Ignition module(s) with high tension lead
- Spark advance module (if equipped)
- Oxygen, speed, throttle position, and temperature sensors (if equipped)
- Electronic control unit (if equipped)
- Fuel injectors (EFI Systems)
- Air filter, fuel filter, and spark plugs (only to first scheduled replacement point)

#### **LIMITATIONS**

This Emission Control Systems Warranty shall not cover any of the following:

- (a) repair or replacement required because of misuse or neglect, improper maintenance, repairs improperly performed or replacements not conforming to Kohler Co. specifications that adversely affect performance and/or durability and alterations or modifications not recommended or approved in writing by Kohler Co.,
- (b) replacement of parts and other services and adjustments necessary for required maintenance at and after the first scheduled replacement point,
- (c) consequential damages such as loss of time, inconvenience, loss of use of the engine or equipment, etc.,
- (d) diagnosis and inspection fees that do not result in eligible warranty service being performed, and
- (e) any add-on or modified part, or malfunction of authorized parts due to the use of add-on or modified parts.

#### **MAINTENANCE AND REPAIR REQUIREMENTS**

The owner is responsible for the proper use and maintenance of the engine. Kohler Co. recommends that all receipts and records covering the performance of regular maintenance be retained in case questions arise. If the engine is resold during the warranty period, the maintenance records should be transferred to each subsequent owner. Kohler Co. reserves the right to deny warranty coverage if the engine has not been properly maintained; however, Kohler Co. may not deny warranty repairs solely because of the lack of repair maintenance or failure to keep maintenance records.

Normal maintenance, replacement or repair of emission control devices and systems may be performed by any repair establishment or individual; however, **warranty repairs must be performed by a Kohler authorized service center**. Any replacement part or service that is equivalent in performance and durability may be used in non-warranty maintenance or repairs, and shall not reduce the warranty obligations of the engine manufacturer.

FOR SALES AND SERVICE INFORMATION  
IN U.S. AND CANADA, CALL  
**1-800-544-2444**

**KOHLER**engines  
**BORN TO RUN™**

ENGINE DIVISION, KOHLER CO., KOHLER, WISCONSIN 53044

FORM NO.:	TP-2474-H
ISSUED:	12/94
REVISED:	12/01
MAILED:	

LITHO IN U.S.A.

# SERVICE MANUAL

## **KOHLER® AEGIS™ 17,20,23 HP**

**LIQUID-COOLED**

**VERTICAL CRANKSHAFT**



**KOHLER**  
**engines**

**BORN  
TO RUN™**



# Contents

---

Section 1. Safety and General Information .....

1

Section 2. Special Tools .....

2

Section 3. Troubleshooting .....

3

Section 4. Air Cleaner and Air Intake System .....

4

Section 5. Fuel System and Governor .....

5

Section 6. Lubrication System .....

6

Section 7. Cooling System .....

7

Section 8. Electrical System and Components .....

8

Section 9. Disassembly .....

9

Section 10. Inspection and Reconditioning .....

10

Section 11. Reassembly .....

11

---

# Section 1 Safety and General Information

## Safety Precautions

To insure safe operations please read the following statements and understand their meaning. Also refer to your equipment manufacturer's manual for other important safety information. This manual contains safety precautions which are explained below. Please read carefully.

 **WARNING**

Warning is used to indicate the presence of a hazard that *can* cause *severe* personal injury, death, or substantial property damage if the warning is ignored.

 **CAUTION**


Caution is used to indicate the presence of a hazard that *will* or *can* cause *minor* personal injury or property damage if the caution is ignored.

**NOTE**



Note is used to notify people of installation, operation, or maintenance information that is important but not hazard-related.



**For Your Safety!**

*These precautions should be followed at all times. Failure to follow these precautions could result in injury to yourself and others.*

 <b>WARNING</b>

<b>Accidental Starts can cause severe injury or death.</b> Disconnect and ground spark plug leads before servicing.

 <b>WARNING</b>

<b>Rotating Parts can cause severe injury.</b> Stay away while engine is in operation.

 <b>WARNING</b>

<b>Hot Parts can cause severe burns.</b> Do not touch engine while operating or just after stopping.



**Accidental Starts!**  
**Disabling engine. Accidental starting can cause severe injury or death.** Before working on the engine or equipment, disable the engine as follows: 1) Disconnect the spark plug lead(s). 2) Disconnect negative (-) battery cable from battery.

**Rotating Parts!**  
Keep hands, feet, hair, and clothing away from all moving parts to prevent injury. Never operate the engine with covers, shrouds, or guards removed.

**Hot Parts!**  
Engine components can get extremely hot from operation. To prevent severe burns, do not touch these areas while the engine is running - or immediately after it is turned off. Never operate the engine with heat shields or guards removed.



# Section 1

## Safety and General Information

 <b>WARNING</b>

<b>Explosive Fuel can cause fires and severe burns.</b>
Stop engine before filling fuel tank.



### Explosive Fuel!

Gasoline is extremely flammable and its vapors can explode if ignited. Store gasoline only in approved containers, in well ventilated, unoccupied buildings, away from sparks or flames. Do not fill the fuel tank while the engine is hot or running, since spilled fuel could ignite if it comes in contact with hot parts or sparks from ignition. Do not start the engine near spilled fuel. Never use gasoline as a cleaning agent.

 <b>WARNING</b>

<b>Carbon Monoxide can cause severe nausea, fainting or death.</b>
Do not operate engine in closed or confined area.

### Lethal Exhaust Gases!



Engine exhaust gases contain poisonous carbon monoxide. Carbon monoxide is odorless, colorless, and can cause death if inhaled. Avoid inhaling exhaust fumes, and never run the engine in a closed building or confined area.

 <b>WARNING</b>

<b>Explosive Gas can cause fires and severe acid burns.</b>
Charge battery only in a well ventilated area. Keep sources of ignition away.

### Explosive Gas!



Batteries produce explosive hydrogen gas while being charged. To prevent a fire or explosion, charge batteries only in well ventilated areas. Keep sparks, open flames, and other sources of ignition away from the battery at all times. Keep batteries out of the reach of children. Remove all jewelry when servicing batteries.

Before disconnecting the negative (-) ground cable, make sure all switches are OFF. If ON, a spark will occur at the ground cable terminal which could cause an explosion if hydrogen gas or gasoline vapors are present.

 <b>WARNING</b>

<b>Cleaning Solvents can cause severe injury or death.</b>
Use only in well ventilated areas away from ignition sources.

### Flammable Solvents!



Carburetor cleaners and solvents are extremely flammable. Keep sparks, flames, and other sources of ignition away from the area. Follow the cleaner manufacturer's warnings and instructions on its proper and safe use. Never use gasoline as a cleaning agent.

 <b>WARNING</b>

<b>Hot liquid can cause severe burns.</b>
Do not loosen radiator cap while engine is operating or warm to the touch.

### Hot Liquid!

The liquid coolant can get extremely hot from operation. Turning the radiator cap when the engine is hot can allow steam and scalding liquid to blow out and burn you severely.

Shut off machine. Only remove radiator cap when cool enough to touch with bare hands. Slowly loosen cap to first stop to relieve pressure before removing completely.

 <b>CAUTION</b>

<b>Electrical Shock can cause injury.</b>
Do not touch wires while engine is running.

### Electrical Shock!

Never touch electrical wires or components while the engine is running. They can be sources of electrical shock.

**Engine Identification Numbers**

When ordering parts, or in any communication involving an engine, always give the **Model, Specification and Serial Numbers**, including letter suffixes if there are any.

The engine identification numbers appear on a decal, or decals, affixed to the engine shrouding. See Figure 1-1. An explanation of these numbers is shown in Figure 1-2.



**Figure 1-1. Engine Identification Decal Location.**

**A. Model No.** **L V 675 S**

Liquid Cooled \_\_\_\_\_

Vertical Crankshaft \_\_\_\_\_

Displacement/Size (cc) \_\_\_\_\_

Version Code  
S = Electric Start

**B. Spec. No.** **85 1500**

Engine Model Code \_\_\_\_\_

Variation of Basic Engine

<u>Code</u>	<u>Model</u>
81	LV560
83	LV625
85	LV675

**C. Serial No.** **30 05810334**

Year Manufactured Code \_\_\_\_\_

Factory Code

<u>Code</u>	<u>Year</u>
30	2000
31	2001

**Figure 1-2. Explanation of Engine Identification Numbers.**

# Section 1

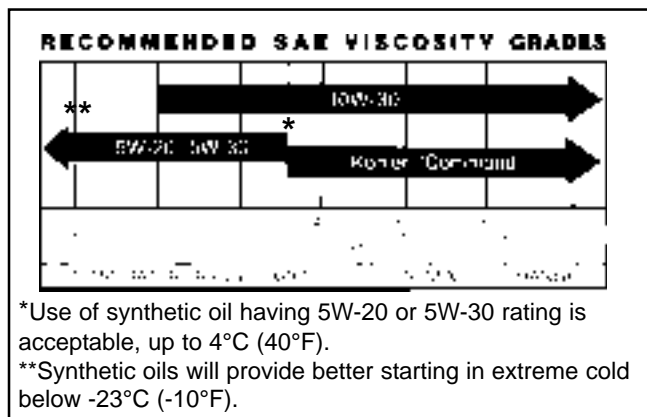
## Safety and General Information

### Oil Recommendations

Using the proper type and weight of oil in the crankcase is extremely important. So is checking oil daily and changing oil regularly. Failure to use the correct oil, or using dirty oil, causes premature engine wear and failure.

#### Oil Type

Use high-quality detergent oil of **API (American Petroleum Institute) Service Class SG, SH, SJ or higher**. Select the viscosity based on the air temperature at the time of operation as shown in the following table.



**NOTE:** Using other than service class SG, SH, SJ or higher oil or extending oil change intervals longer than recommended can cause engine damage.

A logo or symbol on oil containers identifies the API service class and SAE viscosity grade. See Figure 1-3.



Figure 1-3. Oil Container Logo.

Refer to Section 6 - "Lubrication System" for detailed procedures on checking the oil, changing the oil and changing the oil filter.

### Coolant Recommendations

Use equal parts of ethylene glycol and water only. Distilled or deionized water is recommended, especially in areas where the water contains a high mineral content. Propylene glycol based anti-freeze is not recommended.

This mixture will provide protection from -37° C (-34° F) to 108° C (226° F). For protection and use outside the indicated temperature limits, follow the anti-freeze manufacturer's instructions on the container, but do not exceed 70% anti-freeze.

DO NOT use anti-freeze with stop-leak additive(s), or put any other additives in the cooling system.

### Fuel Recommendations



#### WARNING: Explosive Fuel!

*Gasoline is extremely flammable and its vapors can explode if ignited. Store gasoline only in approved containers, in well ventilated, unoccupied buildings, away from sparks or flames. Do not fill the fuel tank while the engine is hot or running, since spilled fuel could ignite if it comes in contact with hot parts or sparks from ignition. Do not start the engine near spilled fuel. Never use gasoline as a cleaning agent.*

### General Recommendations

Purchase gasoline in small quantities and store in clean, approved containers. A container with a capacity of 2 gallons or less with a pouring spout is recommended. Such a container is easier to handle and helps eliminate spillage during refueling.

Do not use gasoline left over from the previous season, to minimize gum deposits in your fuel system and to ensure easy starting.

Do not add oil to the gasoline.

Do not overfill the fuel tank. Leave room for the fuel to expand.

**Fuel Type**

For best results, use only clean, fresh, unleaded gasoline with a pump sticker octane rating of 87 or higher. In countries using the Research method, it should be 90 octane minimum.

Unleaded gasoline is recommended, as it leaves fewer combustion chamber deposits. Leaded gasoline may be used in areas where unleaded is not available and exhaust emissions are not regulated. Be aware, however, that the cylinder head will require more frequent service.

**Gasoline/Alcohol blends**

Gasohol (up to 10% ethyl alcohol, 90% unleaded gasoline by volume) is approved as a fuel for Kohler engines. Other gasoline/alcohol blends are not approved.

**Gasoline/Ether blends**

Methyl Tertiary Butyl Ether (MTBE) and unleaded gasoline blends (up to a maximum of 15% MTBE by volume) are approved as a fuel for Kohler engines. Other gasoline/ether blends are not approved.

**Periodic Maintenance**



**WARNING: Accidental Starts!**

**Disabling engine. Accidental starting can cause severe injury or death.** Before working on the engine or equipment, disable the engine as follows: 1) Disconnect the spark plug lead(s). 2) Disconnect negative (-) battery cable from battery.

**Maintenance Schedule**

These required maintenance procedures should be performed at the frequency stated in the table. They should also be included as part of any seasonal tune-up.

Frequency	Maintenance Required	Refer to:
<b>Daily or Before Starting Engine</b>	<ul style="list-style-type: none"> <li>• Fill fuel tank.</li> <li>• Check oil level.</li> <li>• Check coolant level.</li> <li>• Check air cleaner for dirty<sup>1</sup>, loose, or damaged parts.</li> <li>• Check air intake screen, radiator, and cooling areas, clean as necessary<sup>1</sup>.</li> </ul>	Section 5 Section 6 Section 7 Section 4 Section 4
<b>Every 25 Hours</b>	<ul style="list-style-type: none"> <li>• Service precleaner element<sup>1</sup>.</li> </ul>	Section 4
<b>Every 100 Hours</b>	<ul style="list-style-type: none"> <li>• Replace air cleaner element<sup>1</sup>.</li> <li>• Clean and check cooling areas.</li> <li>• Replace fuel filter.</li> </ul>	Section 4 Section 7 Section 5
<b>Annually or Every 200 Hours</b>	<ul style="list-style-type: none"> <li>• Change oil and oil filter (more frequently under severe conditions).</li> <li>• Check spark plug condition and gap.</li> </ul>	Section 6  Section 8
<b>Annually or Every 500 Hours</b>	<ul style="list-style-type: none"> <li>• Have solenoid shift starter disassembled and cleaned<sup>2</sup>.</li> <li>• Replace spark plugs.</li> </ul>	Section 8 Section 8
<b>Every 2 Years or Every 1000 Hours</b>	<ul style="list-style-type: none"> <li>• Change engine coolant.</li> </ul>	Section 7

<sup>1</sup>Perform these maintenance procedures more frequently under extremely dusty, dirty conditions.

<sup>2</sup>Only required for Denso starters. Not necessary on Delco starters. Have a Kohler Engine Service Dealer perform this service.

## Section 1

# Safety and General Information

---

### Storage

If the engine will be out of service for two months or more, use the following storage procedure:

1. Clean the exterior surfaces of the radiator and engine.
2. Change the oil and filter while the engine is still warm from operation. See "Change Oil and Filter" in Section 6.
3. The coolant (anti-freeze) mixture should be in good condition and tested to guard against freezing in cold temperatures. The recommended equal parts mixture will normally provide protection down to temperatures of  $-37^{\circ}\text{C}$  ( $-34^{\circ}\text{F}$ ). If storage temperatures will fall below this, the cooling system should be drained. A note should then be attached to the equipment and/or engine as a reminder to refill the cooling system before starting.
4. The fuel system must be completely emptied, or the gasoline must be treated with a stabilizer to prevent deterioration. If you choose to use a stabilizer, follow the manufacturer's recommendations, and add the correct amount for the capacity of the fuel system. Fill the fuel tank with clean, fresh gasoline. Run the engine for 2-3 minutes to get stabilized fuel into the carburetor. Close fuel shut-off valve when unit is being stored or transported.  
  
To empty the system, run the engine until the tank and system are empty.
5. Remove the spark plugs. Add one tablespoon of engine oil into each spark plug hole. Install plugs, but do not connect the plug leads. Crank the engine two or three revolutions.
6. Store the engine in a clean, dry place.

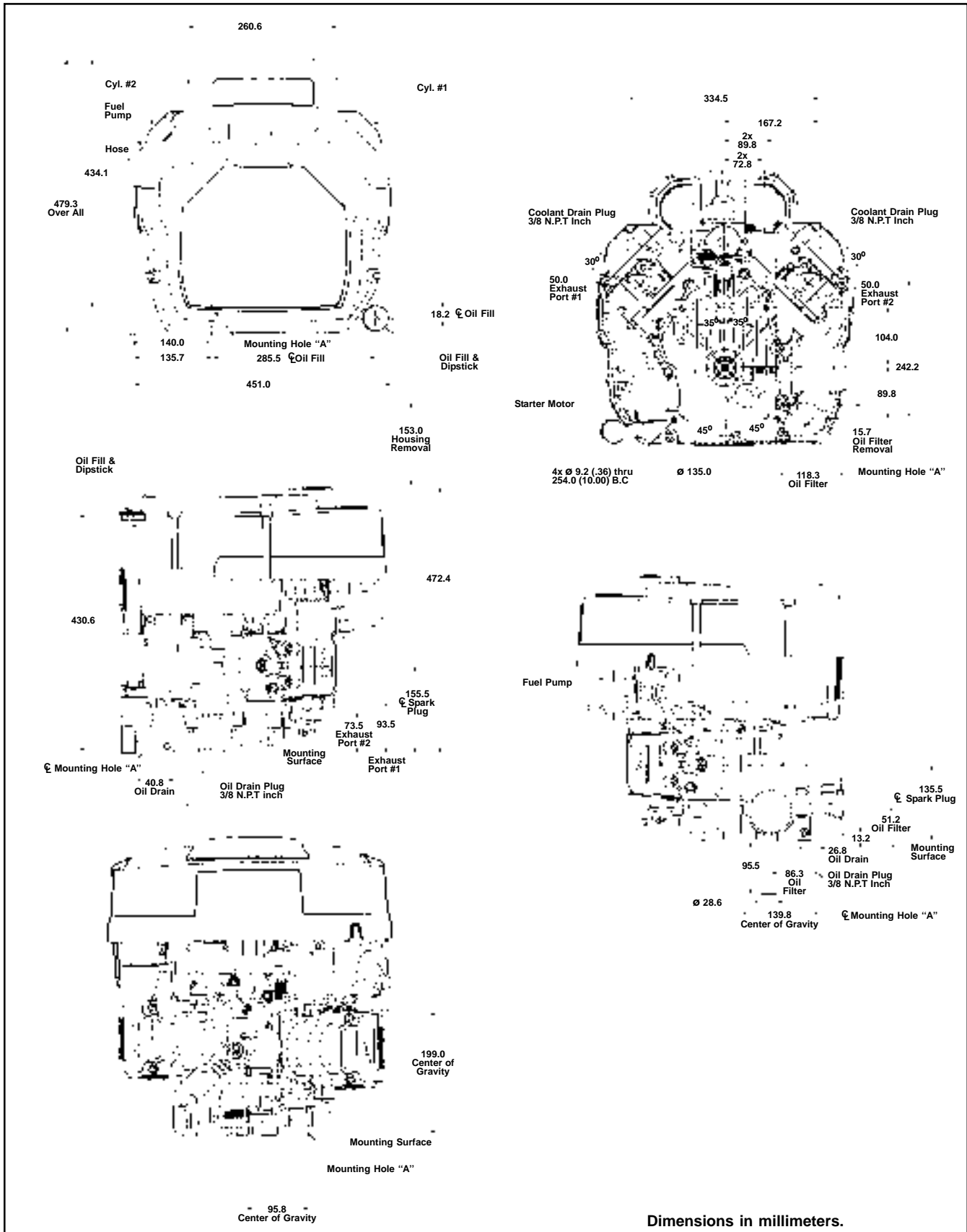


Figure 1-4. Typical Engine Dimensions.



# Section 1

## Safety and General Information

---

### General Specifications<sup>1</sup>

Power (@ 3600 RPM, corrected to SAE J1995)

LV560 .....	12.7 kW (17 HP)
LV625 .....	14.9 kW (20 HP)
LV675 .....	17.1 kW (23 HP)

Peak Torque

LV560 (@ 2400 RPM) .....	32.5 N·m (24 ft. lb.)
LV625 (@ 2400 RPM) .....	41 N·m (30 ft. lb.)
LV675 (@ 2400 RPM) .....	44 N·m (32 ft. lb.)

Bore LV560 .....	73 mm (2.87 in.)
LV625 .....	77 mm (3.03 in.)
LV675 .....	80 mm (3.14 in.)

Stroke .....	67 mm (2.64 in.)
--------------	------------------

Displacement

LV560 .....	561 cc (34.2 cu. in.)
LV625 .....	624 cc (38.1 cu. in.)
LV675 .....	674 cc (41.1 cu. in.)

Compression Ratio .....	8.2:1 (LV560)
	8.5:1 (LV625, LV675)

Dry Weight .....	49.8 kg (110 lb.)
------------------	-------------------

Oil Capacity (with filter) .....	1.9 L (2.0 U.S. qt.)
----------------------------------	----------------------

Coolant Capacity (equal parts of water and ethylene glycol) .....	1.4 L (1.5 U.S. qt.)
-------------------------------------------------------------------	----------------------

Angle of Operation - Maximum (at full oil level) All Directions .....	20°
-----------------------------------------------------------------------	-----

### Lower Blower Housing

M5 Fasteners Torque .....	4.0 N·m (35 in. lb.)
---------------------------	----------------------

M6 Fasteners Torque .....	6.8 N·m (60 in. lb.)
---------------------------	----------------------

Rectifier Fastener Torque .....	4.0 N·m (35 in. lb.)
---------------------------------	----------------------

### Camshaft

End Play (With Shim) .....	0.076/0.127 mm (0.0030/0.0050 in.)
----------------------------	------------------------------------

Running Clearance .....	0.025/0.063 mm (0.0010/0.0025 in.)
-------------------------	------------------------------------

Bore I.D.

New .....	20.000/20.025 mm (0.7874/0.7884 in.)
Max. Wear Limit .....	20.038 mm (0.7889 in.)

Camshaft Bearing Surface O.D.

New .....	19.962/19.975 mm (0.7859/0.7864 in.)
Max. Wear Limit .....	19.959 mm (0.7858 in.)

<sup>1</sup>Values are in Metric units. Values in parentheses are English equivalents. Lubricate threads with engine oil prior to assembly.

---

**Carburetor and Intake Manifold**

Intake Manifold Mounting Fasteners Torque .....	6.2 N·m (55 in. lb.)
Carburetor Mounting Fasteners Torque .....	6.2 N·m (55 in. lb.)

**Connecting Rod**

Cap Fastener Torque (torque in increments) .....	11.3 N·m (100 in. lb.)
Connecting Rod-to-Crankpin Running Clearance	
New .....	0.043/0.068 mm (0.0016/0.0026 in.)
Max. Wear Limit .....	0.083 mm (0.0032 in.)
Connecting Rod-to-Crankpin Side Clearance .....	0.26/0.63 mm (0.0102/0.0248 in.)
Connecting Rod-to-Piston Pin Running Clearance .....	0.015/0.028 mm (0.0006/0.0011 in.)
Piston Pin End I.D.	
New .....	17.015/17.023 mm (0.6699/0.6702 in.)
Max. Wear Limit .....	17.036 mm (0.6707 in.)

**Crankcase**

Governor Cross Shaft Bore I.D.	
New .....	8.025/8.075 mm (0.3159/0.3179 in.)
Max. Wear Limit .....	8.088 mm (0.3184 in.)
Breather Cover Fasteners Torque .....	10.7 N·m (95 in. lb.) Into new as-cast hole 7.3 N·m (65 in. lb.) Into used hole
Oil Drain Plugs .....	13.6 N·m (120 in. lb.)

**Crankshaft**

End Play (free) .....	0.070/0.590 mm (0.0028/0.0232 in.)
Crankshaft Bore (in crankcase)	
New .....	40.974/40.987 mm (1.6131/1.6136 in.)
Max. Wear Limit .....	41.000 mm (1.6141 in.)
Crankshaft Bore (in oil pan)	
New .....	40.974/41.000 mm (1.6131/1.6141 in.)
Max. Wear Limit .....	41.038 mm (1.6156 in.)
Crankshaft Bore (in oil pan)-to-Crankshaft	
Running Clearance - New .....	0.039/0.087 mm (0.0015/0.0034 in.)
Main Bearing Journals	
O.D. - New .....	40.913/40.935 mm (1.6107/1.6116 in.)
O.D. - Max. Wear Limit .....	40.84 mm (1.608 in.)
Max. Taper .....	0.022 mm (0.0009 in.)
Max. Out-of-Round .....	0.025 mm (0.0010 in.)
Crankshaft Bore (in crankcase)-to-Crankshaft	
Running Clearance - New .....	0.039/0.074 mm (0.0015/0.0029 in.)

# Section 1

## Safety and General Information

---

### Crankshaft (Cont'd.)

#### Connecting Rod Journal

O.D. - New .....	35.955/35.973 mm (1.4156/1.4163 in.)
O.D. - Max. Wear Limit .....	35.94 mm (1.415 in.)
Max. Taper .....	0.018 mm (0.0007 in.)
Max. Out-of-Round .....	0.025 mm (0.0010 in.)

#### Crankshaft T.I.R.

PTO End, Crank in Engine .....	0.15 mm (0.0059 in.)
Entire Crank, in V-Blocks .....	0.10 mm (0.0039 in.)

### Cylinder Bore

#### Cylinder Bore I.D.

##### New

LV560 .....	73.006/73.031 mm (2.8742/2.8752 in.)
LV625 .....	77.000/77.025 mm (3.0315/3.0325 in.)
LV675 .....	80.000/80.025 mm (3.1496/3.1506 in.)

##### Max. Wear Limit

LV560 .....	73.070 mm (2.8767 in.)
LV625 .....	77.063 mm (3.0340 in.)
LV675 .....	80.065 mm (3.1522 in.)

Max. Out-of-Round .....	0.12 mm (0.0047 in.)
Max. Taper .....	0.05 mm (0.0020 in.)

### Cylinder Head

Cylinder Head Fastener Torque (torque in 2 increments) ..... 16.9, 33.9 N·m (150, 300 in. lb.)

Max. Out-of-Flatness ..... 0.076 mm (0.003 in.)

Rocker Pivot Fastener Torque, if Screw ..... 11.3 N·m (100 in. lb.)

Rocker Pivot Fastener Torque, if Nut ..... 15.8 N·m (140 in. lb.)

### Electric Starter

Starter Mounting Fastener Torque ..... 15.3 N·m (135 in. lb.)

### Fan/Flywheel

Fan Fastener Torque ..... 13.6 N·m (120 in. lb.)

Flywheel Retaining Screw Torque ..... 66.4 N·m (49 ft. lb.)

### Governor

Governor Cross Shaft to Crankcase Running Clearance ..... 0.025/0.126 mm (0.0009/0.0049 in.)

#### Governor Cross Shaft O.D.

New .....	7.949/8.000 mm (0.3129/0.3149 in.)
Max. Wear Limit .....	7.936 mm (0.3124 in.)

#### Governor Gear Shaft O.D.

New .....	5.990/6.000 mm (0.2358/0.2362 in.)
Max. Wear Limit .....	5.977 mm (0.2353 in.)

Governor Gear Shaft-to-Governor Gear Running Clearance ..... 0.090/0.160 mm (0.0035/0.0063 in.)

**Ignition**

Spark Plug Type (Champion® or equivalent) .....	RC14YC (Kohler Part No. 66 132 01-S)
Spark Plug Gap .....	0.76 mm (0.030 in.)
Spark Plug Torque .....	24.4-29.8 N·m (18-22 ft. lb.)
Ignition Module Air Gap .....	0.2/0.3 mm (0.008/0.012 in.)
Ignition Module Fastener Torque .....	6.2 N·m (55 in. lb.) Into new as-cast hole 3.9 N·m (35 in. lb.) Into used hole

**Muffler**

Muffler Retaining Nuts Torque .....	24.4 N·m (216 in. lb.)
-------------------------------------	------------------------

**Oil Filter/Oil Pan**

Oil Filter Torque .....	8.1-9.4 N·m (72-84 in. lb.)
Oil Pan Fastener Torque .....	24.4 N·m (216 in. lb.)

**Piston, Piston Rings, and Piston Pin**

Piston-to-Piston Pin .....	0.006/0.018 mm (0.0002/0.0007 in.)
Piston Pin Bore I.D.	
New .....	17.006/17.013 mm (0.6695/0.6698 in.)
Max. Wear Limit .....	17.025 mm (0.6703 in.)
Piston Pin O.D.	
New .....	16.995/17.000 mm (0.6691/0.6693 in.)
Max. Wear Limit .....	16.994 mm (0.6691 in.)
Top Compression Ring-to-Groove Side Clearance	
LV560 .....	0.040/0.096 mm (0.0016/0.0037 in.)
LV625 .....	0.040/0.086 mm (0.0016/0.0034 in.)
LV675 .....	0.050/0.096 mm (0.0012/0.0030 in.)
Middle Compression Ring-to-Groove Side Clearance	
LV560 .....	0.030/0.080 mm (0.0012/0.0031 in.)
LV625 .....	0.040/0.086 mm (0.0016/0.0034 in.)
LV675 .....	0.030/0.076 mm (0.0012/0.0030 in.)
Oil Control Ring-to-Groove Side Clearance	
LV560 .....	0.046/0.201 mm (0.0018/0.0079 in.)
LV625 .....	0.046/0.196 mm (0.0018/0.0077 in.)
LV675 .....	0.046/0.196 mm (0.0018/0.0077 in.)

# Section 1

## Safety and General Information

---

### Piston, Piston Rings, and Piston Pin (Cont'd.)

#### Top and Middle Compression Ring End Gap

##### LV560

##### New Bore

Top Ring ..... 0.180/0.380 mm (0.0071/0.0150 in.)

Middle Ring ..... 0.180/0.440 mm (0.0071/0.0173 in.)

Used Bore (Max.) ..... 0.76 mm (0.029 in.)

##### LV625

##### New Bore

Top Ring ..... 0.180/0.380 mm (0.0071/0.0150 in.)

Middle Ring ..... 0.250/0.450 mm (0.0098/0.0177 in.)

Used Bore (Max.) ..... 0.77 mm (0.030 in.)

##### LV675

##### New Bore

Top Ring ..... 0.180/0.430 mm (0.0071/0.0169 in.)

Middle Ring ..... 0.250/0.460 mm (0.0098/0.0181 in.)

Used Bore (Max.) ..... 0.80 mm (0.0315 in.)

#### Piston Thrust Face O.D.<sup>2</sup>

##### LV560

New ..... 72.966/72.984 mm (2.8727/2.8734 in.)

Max. Wear Limit ..... 72.839 mm (2.8677 in.)

##### LV625

New ..... 76.967/76.985 mm (3.0302/3.0309 in.)

Max. Wear Limit ..... 76.840 mm (3.0252 in.)

##### LV675

New ..... 79.963/79.981 mm (3.1481/3.1488 in.)

Max. Wear Limit ..... 79.831 mm (3.1430 in.)

#### Piston Thrust Face-to-Cylinder Bore<sup>2</sup> Running Clearance

LV560 ..... 0.022/0.065 mm (0.0009/0.0026 in.)

LV625 ..... 0.014/0.057 mm (0.0005/0.0022 in.)

LV675 ..... 0.019/0.062 mm (0.0007/0.0024 in.)

### Speed Control

Speed Control Bracket Assembly Fastener Torque ..... 10.7 N·m (95 in. lb.) Into new as-cast hole  
7.3 N·m (65 in. lb.) Into used hole

### Stator

Stator Mounting Screw Torque ..... 6.2 N·m (55 in. lb.)

### Throttle/Choke Controls

Governor Control Lever Fastener Torque ..... 9.9 N·m (88 in. lb.)

### Valve Cover/Rocker Arms

Valve Cover Fastener Torque ..... 6.2 N·m (55 in. lb.)

### Valves and Valve Lifters

Hydraulic Valve Lifter to Crankcase Running Clearance ..... 0.0124/0.0501 mm (0.0004/0.0020 in.)

Intake Valve Stem-to-Valve Guide Running Clearance ..... 0.038/0.076 mm (0.0015/0.0030 in.)

Exhaust Valve Stem-to-Valve Guide Running Clearance ..... 0.050/0.088 mm (0.0020/0.0035 in.)

<sup>2</sup>Measure 6 mm (0.236 in.) above the bottom of the piston skirt at right angles to the piston pin.

**Valves and Valve Lifters (Cont'd.)**

Intake Valve Guide I.D.	
New .....	7.038/7.058 mm (0.2771/0.2779 in.)
Max. Wear Limit .....	7.134 mm (0.2809 in.)
Intake Valve Stem Diameter	
New .....	6.982/7.000 mm (0.2749/0.2756 in.)
Exhaust Valve Guide I.D.	
New .....	7.038/7.058 mm (0.2771/0.2779 in.)
Max. Wear Limit .....	7.159 mm (0.2819 in.)
Exhaust Valve Stem Diameter	
New .....	6.970/6.988 (0.2744/0.2751 in.)
Valve Guide Reamer Size	
Standard .....	7.048 mm (0.2775 in.)
0.25 mm O.S. ....	7.298 mm (0.2873 in.)
Intake Valve Minimum Lift .....	
	8.88 mm (0.3496 in.)
Exhaust Valve Minimum Lift .....	
	8.88 mm (0.3496 in.)
Nominal Valve Seat Angle .....	
	45°

**General Torque Values**

**Metric Fastener Torque Recommendations for Standard Applications**

<b>Tightening Torque: N·m (in. lb.) + or - 20%</b>						
	<b>Property Class</b>					
<b>Size</b>						<b>Noncritical Fasteners Into Aluminum</b>
<b>M4</b>	1.2 (11)	1.7 (15)	2.9 (26)	4.1 (36)	5.0 (44)	2.0 (18)
<b>M5</b>	2.5 (22)	3.2 (28)	5.8 (51)	8.1 (72)	9.7 (86)	4.0 (35)
<b>M6</b>	4.3 (38)	5.7 (50)	9.9 (88)	14.0 (124)	16.5 (146)	6.8 (60)
<b>M8</b>	10.5 (93)	13.6 (120)	24.4 (216)	33.9 (300)	40.7 (360)	17.0 (150)





  

<b>Tightening Torque: N·m (ft. lb.) + or -20%</b>						
	<b>Property Class</b>					
<b>Size</b>						<b>Noncritical Fasteners Into Aluminum</b>
<b>M10</b>	21.7 (16)	27.1 (20)	47.5 (35)	66.4 (49)	81.4 (60)	33.9 (25)
<b>M12</b>	36.6 (27)	47.5 (35)	82.7 (61)	116.6 (86)	139.7 (103)	61.0 (45)
<b>M14</b>	58.3 (43)	76.4 (55)	131.5 (97)	184.4 (136)	219.7 (162)	94.9 (70)

# Section 1

## Safety and General Information

### English Fastener Torque Recommendations for Standard Applications

Tightening Torque: N·m (in. lb.) + or - 20%				
Bolts, Screws, Nuts and Fasteners Assembled Into Cast Iron or Steel				Grade 2 or 5 Fasteners Into Aluminum
	 Grade 2	 Grade 5	 Grade 8	
<b>Size</b>				
8-32	2.3 (20)	2.8 (25)	-----	2.3 (20)
10-24	3.6 (32)	4.5 (40)	-----	3.6 (32)
10-32	3.6 (32)	4.5 (40)	-----	-----
1/4-20	7.9 (70)	13.0 (115)	18.7 (165)	7.9 (70)
1/4-28	9.6 (85)	15.8 (140)	22.6 (200)	-----
5/16-18	17.0 (150)	28.3 (250)	39.6 (350)	17.0 (150)
5/16-24	18.7 (165)	30.5 (270)	-----	-----
3/8-16	29.4 (260)	-----	-----	-----
3/8-24	33.9 (300)	-----	-----	-----
Tightening Torque: N·m (ft. lb.) + or - 20%				
<b>Size</b>				
5/16-24	-----	-----	40.7 (30)	-----
3/8-16	-----	47.5 (35)	67.8 (50)	-----
3/8-24	-----	54.2 (40)	81.4 (60)	-----
7/16-14	47.5 (35)	74.6 (55)	108.5 (80)	-----
7/16-20	61.0 (45)	101.7 (75)	142.4 (105)	-----
1/2-13	67.8 (50)	108.5 (80)	155.9 (115)	-----
1/2-20	94.9 (70)	142.4 (105)	223.7 (165)	-----
9/16-12	101.7 (75)	169.5 (125)	237.3 (175)	-----
9/16-18	135.6 (100)	223.7 (165)	311.9 (230)	-----
5/8-11	149.2 (110)	244.1 (180)	352.6 (260)	-----
5/8-18	189.8 (140)	311.9 (230)	447.5 (330)	-----
3/4-10	199.3 (150)	332.2 (245)	474.6 (350)	-----
3/4-16	271.2 (200)	440.7 (325)	637.3 (470)	-----

### Torque Conversions

N·m = in. lb. x 0.113  
 N·m = ft. lb. x 1.356  
 in. lb. = N·m x 8.85  
 ft. lb. = N·m x 0.737

# Section 2 Special Tools

2

These quality tools are designed to help you perform specific disassembly, repair, and reassembly procedures. By using tools designed for the job, you can service engines easier, faster, and safer! In addition, you'll increase your service capabilities and customer satisfaction by decreasing engine downtime.

Camshaft End play Plate .....	KO1031*
Flywheel Puller Kit .....	NU3226*
Hose Clamp Pliers .....	KO1043*
Valve Guide Reamer .....	KO1026*
Hydraulic Lifter Removal Tool .....	KO1044*
Rocker Arm Spanner Wrench .....	(Obtain locally)
Water Manometer .....	25 761 02-S
Vacuum Gauge .....	25 761 22-S
Cylinder Leakdown Tester .....	25 761 05-S
Ignition System Tester .....	24 455 02-S
Starter Ring Tool .....	25 761 18-S

\*These items can be ordered through your Kohler distributor or purchased directly from SPX Corp. by phoning 1-800-533-0492.

### Ignition System Tester

Use Kohler Part No. 24 455 02-S to test the CD ignition modules on the AEGIS™ engines.

### Cylinder Leakdown Tester

Kohler Part No. 25 761 05-S Cylinder Leakdown Tester is a valuable alternative to a compression test. By pressurizing the combustion chamber from an external air source, this tool can determine if valves or rings are leaking. Instructions for using this tester are found on pages 3.3 and 3.4 of this manual.



Figure 2-1. Hose Clamp Pliers.



## Section 2

### Special Tools

---

#### Special Tools You Can Make

##### Flywheel Holding Tool

Flywheel removal and reinstallation becomes a “snap” using a handy holding tool you can make out of a piece of an old “junk” flywheel ring gear as shown in Figure 2-2. Using an abrasive cut-off wheel, cut out a six tooth segment of the ring gear as shown. Grind off any burrs or sharp edges. The segment can be used in place of a strap wrench. Invert the segment and place it between the ignition module bosses on the #1 cylinder so that the tool teeth engage the ring gear teeth on the flywheel. The bosses will “lock” the tool and flywheel in position for loosening, tightening, or removing with a puller.

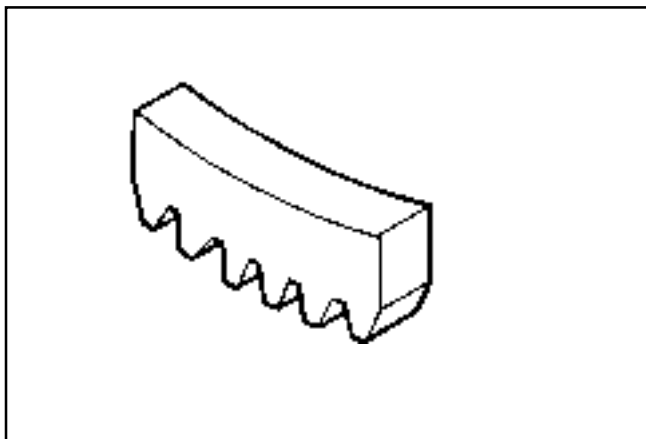


Figure 2-2. Flywheel Holding Tool.

##### RTV Silicone Sealant

RTV (Room Temperature Vulcanizing) silicone sealant is used as a gasket between the crankcase and oil pan.

Only oxime-based, oil resistant RTV sealants, such as those listed below, are approved for use. Loctite® Nos. 5900 and 5910 are recommended for best sealing characteristics.

Loctite® Ultra Blue 587  
Loctite® Ultra Copper  
Loctite® Ultra Black 598  
Loctite® 5900 (Heavy Body)  
Loctite® 5910

NOTE: Always use **fresh** sealant. Using outdated sealant can result in leakage.

# Section 3

## Troubleshooting

### Troubleshooting Guide

When troubles occur, be sure to check the simple causes which, at first, may seem too obvious to be considered. For example, a starting problem could be caused by an empty fuel tank.

Some common causes of engine troubles are listed below. Use these to locate the causing factors.

#### Engine Cranks But Will Not Start

1. Empty fuel tank.
2. Fuel shut-off valve closed.
3. Dirt or water in the fuel system.
4. Clogged fuel line.
5. Spark plug lead(s) disconnected.
6. Key switch or kill switch in "off" position.
7. Faulty spark plugs.
8. Faulty ignition module.
9. Carburetor solenoid malfunction.
10. Diode in wiring harness failed in open circuit mode.
11. Vacuum fuel pump malfunction, or oil in vacuum hose.
12. Vacuum hose to fuel pump leaking/cracked.
13. Battery connected backwards.

#### Engine Starts But Does Not Keep Running

1. Restricted fuel tank cap vent.
2. Dirt or water in the fuel system.
3. Faulty choke or throttle controls.
4. Loose wires or connections that short the kill terminal of ignition module to ground.
5. Faulty cylinder head gasket.
6. Faulty carburetor.
7. Vacuum fuel pump malfunction, or oil in vacuum hose.
8. Leaking/cracked vacuum hose to fuel pump.

#### Engines Starts Hard

1. PTO drive is engaged.
2. Dirt or water in the fuel system.
3. Clogged fuel line.
4. Loose or faulty wires or connections.
5. Faulty choke or throttle controls.

6. Faulty spark plugs.
7. Low compression.
8. Weak spark.
9. Fuel pump malfunction causing lack of fuel.
10. Engine overheated-cooling system problem.

#### Engine Will Not Crank

1. PTO drive is engaged.
2. Battery is discharged.
3. Safety interlock switch is engaged.
4. Loose or faulty wires or connections.
5. Faulty key switch or ignition switch.
6. Faulty electric starter or solenoid.
7. Seized internal engine components.

#### Engine Runs But Misses

1. Dirt or water in the fuel system.
2. Spark plug lead disconnected.
3. Loose wires or connections that intermittently short the kill circuit of ignition system to ground.
4. Engine overheated-cooling system problem.
5. Faulty ignition module.
6. Faulty spark plugs.
7. Carburetor adjusted incorrectly.
8. Faulty interlock switch.

#### Engine Will Not Idle

1. Restricted fuel tank cap vent.
2. Dirt or water in the fuel system.
3. Faulty spark plugs.
4. Idle speed (RPM) adjusting screw improperly set.
5. Low compression.
6. Stale fuel and/or gum in carburetor.
7. Fuel supply inadequate.
8. Engine overheated-cooling system problem.

#### Engine Overheats

1. Air intake/grass screen, radiator, or cooling shrouds clogged.
2. Excessive engine load.
3. Low crankcase oil level.
4. High crankcase oil level.
5. Faulty carburetor.
6. Low coolant level.

## Section 3

### Troubleshooting

---

#### Engine Overheats (cont'd.)

7. Radiator cap faulty or loose.
8. Lean fuel mixture.
9. Water pump belt failed/off.
10. Water pump malfunction.

#### Engine Knocks

1. Excessive engine load.
2. Low crankcase oil level.
3. Old or improper fuel.
4. Internal wear or damage.
5. Hydraulic lifter malfunction.

#### Engine Loses Power

1. Low crankcase oil level.
2. High crankcase oil level.
3. Dirty air cleaner element.
4. Dirt or water in the fuel system.
5. Excessive engine load.
6. Engine overheated.
7. Faulty spark plugs.
8. Low compression
9. Exhaust restriction.
10. Low battery.

#### Engine Uses Excessive Amount Of Oil

1. Incorrect oil viscosity/type.
2. Clogged or improperly assembled breather.
3. Worn or broken piston rings.
4. Worn cylinder bore.
5. Worn valve stems or valve guides.
6. Crankcase overfilled.

#### Oil Leaks from Oil Seals, Gaskets

1. Crankcase breather is clogged or inoperative.
2. Loose or improperly torqued fasteners.
3. Piston blowby or leaky valves.
4. Restricted exhaust.

#### Engine Loses or Uses Coolant

1. Overheating-See "Engine Overheats" section.
2. External leakage-from a joint connection, or a component of the cooling system.
3. Internal leakage-from a head gasket, or cooling system water jacket (passage) leak.

#### External Engine Inspection

Before cleaning or disassembling the engine, make a thorough inspection of its external appearance and condition. This inspection can give clues to what might be found inside the engine (and the cause) when it is disassembled.

- Check for buildup of dirt and debris on the radiators, crankcase, cooling fins, grass screen, blower housing and other external surfaces. Dirt or debris on these areas are causes of higher operating temperatures and overheating.
- Check for obvious fuel, oil, and coolant leaks, or damaged components. Excessive oil leakage can indicate a clogged or improperly assembled breather, worn or damaged seals and gaskets, or loose or improperly torqued fasteners. Coolant leaks can cause higher operating temperatures and overheating.
- Check the air cleaner and base for damage or indications of improper fit and seal.
- Check the air cleaner element. Look for holes, tears, cracked or damaged sealing surfaces, or other damage that could allow unfiltered air into the engine. Also note if the element is dirty or clogged. These could indicate that the engine has been underserviced.
- Check the carburetor throat for dirt. Dirt in the throat is further indication that the air cleaner is not functioning properly.
- Check the oil level. Note if the oil level is within the operating range on the dipstick, or if it is low or overfilled.
- Check the coolant level within the reservoir and in the neck of radiator cap adapter. A low or improperly filled cooling system can cause overheating, excessive fuel consumption, and a lack of power.
- Check the condition of the oil. Drain the oil into a container - the oil should flow freely. Check the appearance (color) of the oil, and for metal chips or foreign particles. A milky, opaque color denotes the presence of engine coolant in the crankcase oil.

Sludge is a natural by-product of combustion; a small accumulation is normal. Excessive sludge formation could indicate overrich carburetion, weak ignition, overextended oil change intervals or wrong weight or type of oil was used, to name a few.

**NOTE:** It is good practice to drain oil at a location away from the workbench. Be sure to allow ample time for complete drainage.

### Cleaning the Engine

After inspecting the external condition of the engine, clean the engine thoroughly before disassembling it. Also clean individual components as the engine is disassembled. Only clean parts can be accurately inspected and gauged for wear or damage. There are many commercially available cleaners that will quickly remove grease, oil, and grime from engine parts. When such a cleaner is used, *follow the manufacturer's instructions and safety precautions carefully.*

Make sure all traces of the cleaner are removed before the engine is reassembled and placed into operation. Even small amounts of these cleaners can quickly break down the lubricating properties of engine oil.

### Basic Engine Tests

#### Crankcase Vacuum Test

A partial vacuum should be present in the crankcase when the engine is operating. Pressure in the crankcase (normally caused by a clogged or improperly assembled breather) can cause oil to be forced out at oil seals, gaskets, or other available spots.

Crankcase vacuum is best measured with either a water manometer (Kohler Part No. 25 761 02-S) or a vacuum gauge (Kohler Part No. 25 761 22-S). Complete instructions are provided in kits.

Test the crankcase vacuum with the manometer as follows:

1. Insert the stopper/hose into the oil fill hole. Leave the other tube of manometer open to atmosphere. Make sure the shut-off clamp is closed.

2. Start the engine and run at no-load high idle speed (3200 to 3750 RPM).
3. Open the clamp and note the water level in the tube.

The level in the engine side should be a minimum of **10.2 cm (4 in.)** above the level in the open side.

If the level in the engine side is less than specified (low/no vacuum), or the level in the engine side is lower than the level in the open side (pressure), check for the conditions in the table below.

4. Close the shut-off clamp **before** stopping the engine.

#### Compression Test

A compression test is best performed on a warm engine. Clean any dirt or debris away from the base of the spark plugs before removing them. Be sure the choke is off, and the throttle is wide open during the test. Compression should be at least 160 psi and should not vary more than 15% between cylinders.

#### Cylinder Leakdown Test

A cylinder leakdown test can be a valuable alternative to a compression test. By pressurizing the combustion chamber from an external air source you can determine if the valves or rings are leaking, and how badly.

Kohler Part No. 25 761 05-S is a relatively simple, inexpensive leakdown tester for small engines. The tester includes a quick disconnect for attaching the adapter hose and a holding tool.

#### No Crankcase Vacuum/Pressure in Crankcase

Possible Cause	Solution
1. Crankcase breather clogged or inoperative.	1. Replace breather assembly (valve cover).
2. Seals and/or gaskets leaking. Loose or improperly torqued fasteners.	2. Replace all worn or damaged seals and gaskets. Make sure all fasteners are tightened securely. Use appropriate torque values and sequences when necessary.
3. Piston blowby or leaky valves. (Confirm by inspecting components.)	3. Recondition piston, rings, cylinder bore, valves, and valve guides.
4. Restricted exhaust.	4. Repair/replace restricted muffler/exhaust system.

## Section 3 Troubleshooting

---

### Leakdown Test Instructions

1. Run engine 3-5 minutes to warm it up.
2. Remove spark plugs, dipstick, and air filter from engine.
3. Rotate crankshaft until piston (of cylinder being tested) is at top dead center (TDC) of compression stroke. You will need to hold the engine in this position while testing. The holding tool supplied with the tester can be used if the PTO end of the crankshaft is accessible. Slide the holding tool onto the crankshaft and adjust the set screw to fit in the key slot. Install a 3/8" breaker bar into the square hole of the holding tool, so it is perpendicular to both the holding tool and crankshaft PTO. If the flywheel end is more accessible, you can use a breaker bar and socket on the flywheel nut/screw to hold it in position. You may need an assistant to hold the breaker bar during testing.

If the engine is mounted in a piece of equipment, you may be able to hold it by clamping or wedging a driven component. Just be certain that the engine cannot rotate off of TDC in either direction.

4. Install the adapter hose into the spark plug hole, but do not attach it to the tester at this time.
5. Connect an adequate air source to the tester.
6. Turn the regulator knob in the increase (clockwise) direction until the gauge needle is in the yellow "set" area at the low end of the scale.
7. Connect tester quick-disconnect to the adapter. Note the gauge reading and listen for escaping air at the carburetor intake, exhaust outlet, and oil fill/dipstick tube.
8. Check your test results against the table below:

### Leakdown Test Results

Air escaping at oil fill tube .....	Defective rings, worn cylinder walls, or blown head gasket.
Air escaping from exhaust outlet .....	Defective exhaust valve.
Air escaping from carburetor inlet .....	Defective intake valve.
Gauge reading in "low" (green) zone .....	Piston rings and cylinder in good condition.
Gauge reading in "moderate" (yellow) zone .....	Engine is still usable, but there is some wear present. Customer should start planning for overhaul or replacement.
Gauge reading in "high" (red) zone .....	Rings and/or cylinder have considerable wear. Engine should be reconditioned or replaced.

### Cooling Leakage Test

A pressure test can be performed as a simple means of determining whether the cooling system may have a problem. The test procedure, possible results, and recommended corrective action are covered in Section 7.

## Section 4

# Air Cleaner and Air Intake System

4

### Air Intake System

#### General

All intake air, for both cooling and combustion, is drawn in through the screen in the upper blower housing.

#### Service

Check the air intake screen **daily or before starting the engine**. Check for a buildup of dirt or debris on the screen. A small accumulation can be brushed off with the screen in place. See Figure 4-1. For a heavier buildup, loosen the four rubber retaining straps and remove the upper blower housing/screen assembly from the engine. See Figure 4-2. Take the housing assembly outdoors or to a trash container and brush off the screen, or use compressed air and blow it off from the back side. Also check that the screen and housing are not cracked or damaged.



Figure 4-1. Cleaning Air Intake Screen.

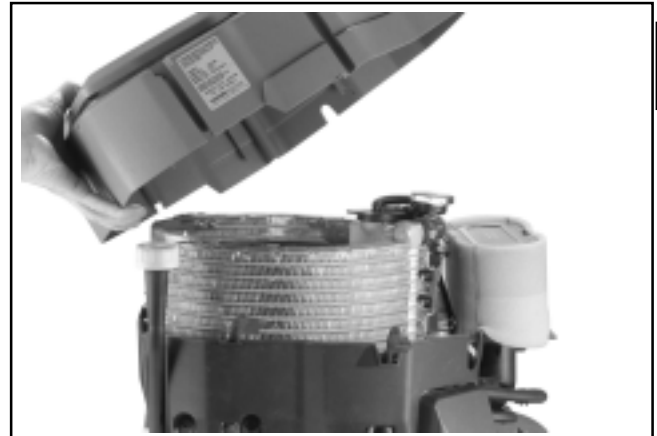


Figure 4-2. Removing Upper Blower Housing and Screen Assembly.

In addition to the daily check, the intake screen should have a thorough cleaning every **100 hours** (more frequently under extremely dusty or dirty conditions). If necessary, the screen assembly may be separated from the upper blower housing by unsnapping it from the underside. See Figure 4-3 and 4-4.

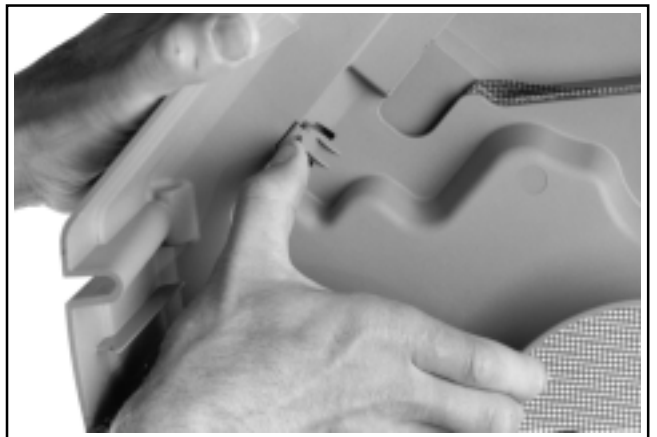


Figure 4-3. Unsnapping Screen Assembly.

## Section 4

### Air Cleaner and Air Intake System



Figure 4-4. Cleaning Separated Screen Assembly.

Always reinstall the upper blower assembly after it has been removed for service. **Do not** operate the engine with the upper blowing housing or screen removed.

#### Air Cleaner

##### General

These engines are equipped with a replaceable, high-density paper air cleaner element surrounded by an oil, foam precleaner, located under the upper blower housing. See Figures 4-5 and 4-6.

##### Service

**Daily or before starting the engine**, remove the upper blowing housing and check the air cleaner system. See Figures 4-5 and 4-6. Again, check for dirt or debris and clean it away. Make sure the precleaner is not damaged, ripped, or missing. The air cleaner elements must be fastened with the retainer strap, and the bottom of the element must be sealed against the air cleaner base. Make sure the base is secured tightly to the carburetor and not cracked or damaged. Also make sure the breather hose is secured to the air cleaner base and to the breather outlet fitting on the valve cover.

**NOTE:** Damaged, worn or loose breather hose or air cleaner components can allow unfiltered air into the engine causing premature wear and failure. Tighten or replace all loose or damaged components.



Figure 4-5. Air Cleaner Assembly.

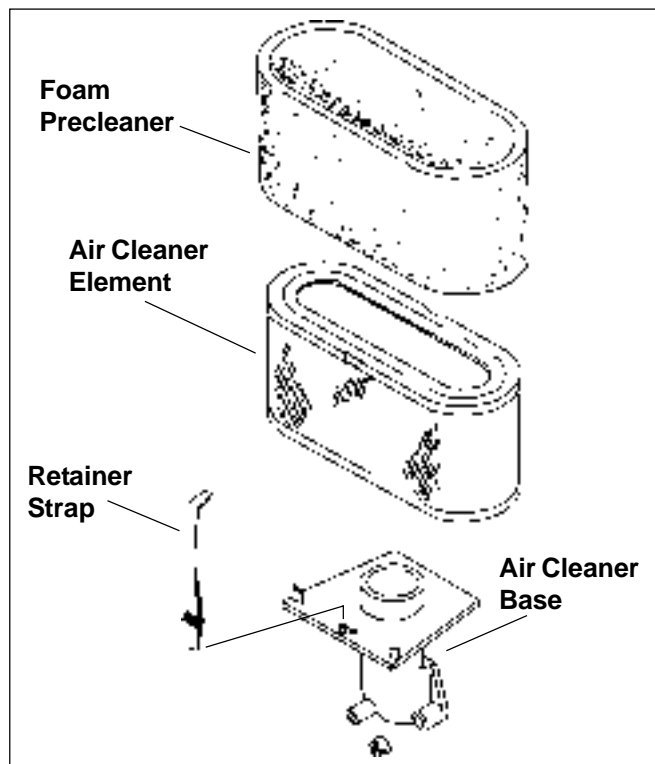


Figure 4-6. Air Cleaner System Components.

##### Precleaner Service

If so equipped, wash and reoil the precleaner every **25 hours** of operation (more often under extremely dusty or dirty conditions).

To service the precleaner perform the following steps.

1. Unhook the four retaining straps and remove the upper blower housing and screen assembly. See Figure 4-2.

2. Remove the precleaner from the paper element. See Figure 4-7.



Figure 4-7. Removing Precleaner from Paper Element.

3. Wash the precleaner in warm water with detergent. Rinse the precleaner thoroughly until all traces of detergent are eliminated. Squeeze out excess water (do not wring). Allow the precleaner to air dry.
4. Saturate the precleaner with new engine oil. Squeeze out all excess oil.
5. Reinstall the serviced precleaner over the paper element, outside the filter element retaining strap.
6. Clean the air cleaner base area, upper blower housing, and screen assembly of any debris accumulation.
7. Reinstall the upper blower housing/screen assembly, and secure with the four retaining straps.
8. When precleaner replacement is necessary, order Kohler Part No. 66 083 03-S.

#### Paper Element Service (Standard Type)

Every **100 hours** of operation (more often under extremely dusty or dirty conditions), replace the paper element.

1. Unhook the four retaining straps and remove the upper blower housing and screen assembly. See Figure 4-2.
2. Remove the precleaner from the paper element. See Figure 4-7.

3. Unhook the filter element retaining strap and remove the paper element from the air cleaner base. See Figure 4-8.

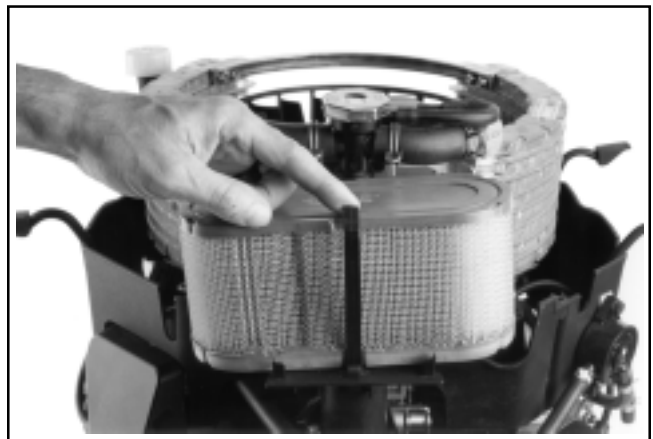


Figure 4-8. Unhooking Retainer Strap.

4. **Do not wash the paper element or use pressurized air**, this will damage the element. Replace a dirty, bent, or damaged element with a genuine Kohler element. Handle new elements carefully; do not use if the sealing surfaces are bent or damaged.
5. Clean the air cleaner base area, upper blower housing, an screen assembly of any debris accumulation.
6. Install the new paper element; Kohler Part No. 66 083 01-S and secure with the filter element retainer strap.

#### Disassembly/Reassembly - Standard Type

If the air cleaner base has to be removed, proceed as follows.

1. Unhook the four retaining straps and remove the upper blower housing and screen assembly. See Figure 4-2.
2. Remove the precleaner and air cleaner element from base. See Figures 4-7 and 4-8.
3. Remove the two hex. flange nuts securing air cleaner base and mounting clamp for vacuum (fuel pump) hose onto carburetor studs. See Figure 4-9.



## Section 4

### Air Cleaner and Air Intake System

---

4. Disconnect the breather hose from the air cleaner base.

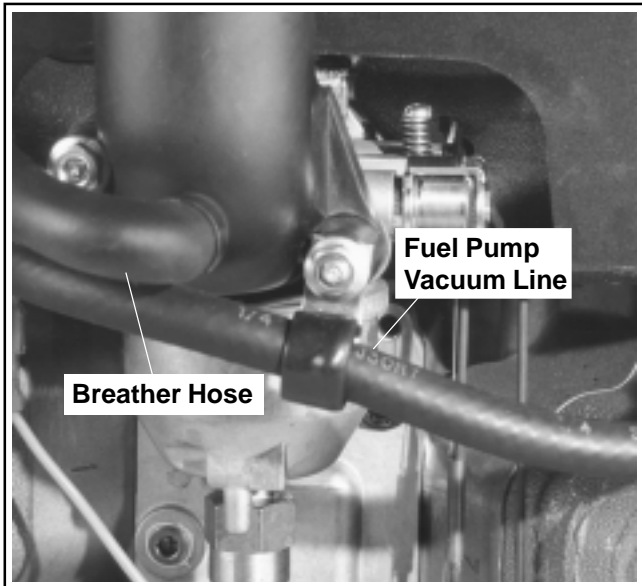


Figure 4-9. Base Plate Removal on Standard Type.

5. Slide the clamp and air cleaner base off the stud.
6. Reverse procedure to reassemble components.  
Torque the hex. flange nuts to **9.9 N·m (88 in. lb.)**.

#### Radiator Cleaning

Every time the upper blower housing assembly is removed to check or service the air cleaner, the condition of the radiators should also be checked. If the cleaning is necessary, follow the instructions in Section 7 Cooling System, found on page 7.2, "Cooling System Maintenance and Service."

# Section 5

## Fuel System and Governor

### Description



#### **WARNING: Explosive Fuel!**

Gasoline is extremely flammable and its vapors can explode if ignited. Store gasoline only in approved containers, in well ventilated, unoccupied buildings, away from sparks or flames. Do not fill the fuel tank while the engine is hot or running, since spilled fuel could ignite if it comes in contact with hot parts or sparks from ignition. Do not start the engine near spilled fuel. Never use gasoline as a cleaning agent.

### Fuel System Components

The typical fuel system and related components include the following:

- Fuel Tank
- In-line Fuel Filter
- Fuel Pump
- Carburetor
- Fuel Lines

### Operation

The fuel from the tank is moved through the in-line filter and fuel lines by the fuel pump. On engines not equipped with a fuel pump, the fuel tank outlet is located above the carburetor inlet allowing gravity to feed fuel to the carburetor.

Fuel then enters the carburetor float bowl and is moved into the carburetor body. There, the fuel is mixed with air. This fuel-air mixture is then burned in the engine combustion chamber.

### Fuel Recommendations

#### General Recommendations

Purchase gasoline in small quantities and store in clean, approved containers. A container with a capacity of 2 gallons or less with a pouring spout is recommended. Such a container is easier to handle and helps eliminate spillage during refueling.

- Do not use gasoline left over from the previous season, to minimize gum deposits in your fuel system and to ensure easy starting.
- Do not add oil to the gasoline.
- Do not overfill the fuel tank. Leave room for the fuel to expand.

### Fuel Type

For best results, use only clean, fresh, unleaded gasoline with a pump sticker octane rating of 87 or higher. In countries using the Research fuel rating method, it should be 90 octane minimum.

Unleaded gasoline is recommended, as it leaves less combustion chamber deposits. Leaded gasoline may be used in areas where unleaded is not available and exhaust emissions are not regulated. Be aware however, that the cylinder head will require more frequent service.

### Gasoline/Alcohol blends

Gasohol (up to 10% ethyl alcohol, 90% unleaded gasoline by volume) is approved as a fuel for Kohler engines. Other gasoline/alcohol blends are not approved.

### Gasoline/Ether blends

Methyl Tertiary Butyl Ether (MTBE) and unleaded gasoline blends (up to a maximum of 15% MTBE by volume) are approved as a fuel for Kohler engines. Other gasoline/ether blends are not approved.

### Fuel Filter

Most engines are equipped with an in-line fuel filter. Periodically inspect the filter and replace when dirty with a genuine Kohler filter.

## Section 5

### Fuel System and Governor

---

#### Fuel System Tests

When the engine starts hard, or turns over but will not start, it is possible that the problem is in the fuel system. To find out if the fuel system is causing the problem, perform the following tests.

#### Troubleshooting – Fuel System Related Causes

Test	Conclusion
1. Check the following: <ol style="list-style-type: none"> <li>a. Make sure the fuel tank contains clean, fresh, proper fuel.</li> <li>b. Make sure the vent in fuel tank cap is open.</li> <li>c. Make sure the fuel valve is open.</li> <li>d. Make sure vacuum and fuel lines to fuel pump are secured and in good condition.</li> </ol>	
2. Check for fuel in the combustion chamber. <ol style="list-style-type: none"> <li>a. Disconnect and ground spark plug leads.</li> <li>b. Close the choke on the carburetor.</li> <li>c. Crank the engine several revolutions.</li> <li>d. Remove the spark plug and check for fuel at the tip.</li> </ol>	2. If there <b>is</b> fuel at the tip of the spark plug, fuel is reaching the combustion chamber.  If there is <b>no</b> fuel at the tip of the spark plug, check for fuel flow from the fuel tank (Test 3).
3. Check for fuel flow from the tank to the fuel pump. <ol style="list-style-type: none"> <li>a. Remove the fuel line from the inlet fitting of fuel pump.</li> <li>b. Hold the line below the bottom of the tank. Open the shut-off valve (if so equipped) and observe flow.</li> </ol>	3. If fuel <b>does</b> flow from the line, check for faulty fuel pump (Test 4).  If fuel <b>does not</b> flow from the line, check the fuel tank vent, fuel pickup screen, in-line filter, shut-off valve, and fuel line. Correct any observed problem and reconnect the line.
4. Check the operation of fuel pump. <ol style="list-style-type: none"> <li>a. Remove the fuel line from the inlet fitting of carburetor.</li> <li>b. Crank the engine several times and observe flow.</li> </ol>	4. If fuel <b>does</b> flow from the line, check for faulty carburetor. (Refer to the "Carburetor" portions of this section).  If fuel <b>does not</b> flow from the line, check for a clogged fuel line. If the fuel line is unobstructed, check for overfilled crankcase and/or oil in pulse line. If none of the checks reveal the cause of the problem, replace the pump.

## Fuel Pump

### General

These engines are equipped with an external pulse fuel pump. The pumping action is created by the oscillation of positive and negative pressures within the crankcase. This pressure is transmitted to the pulse pump through a rubber hose connected between the pump and crankcase. The pumping action causes the diaphragm on the inside of the pump to pull fuel in on its downward stroke and to push it into the carburetor on its upward stroke. Two check valves prevent fuel from going backward through the pump.

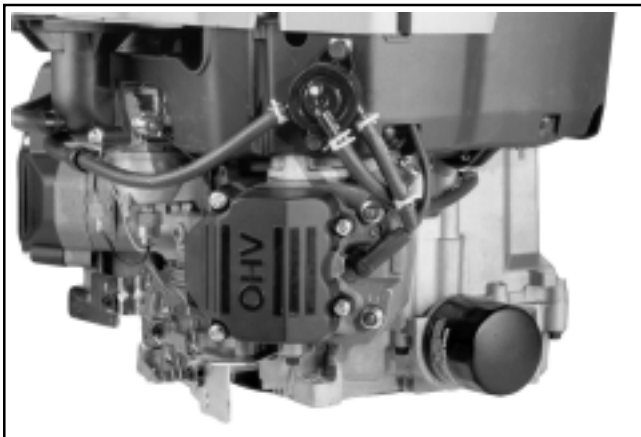
### Performance

Minimum fuel delivery rate must be 7.5 L/hr. (2 gal./hr.) with a pressure at .3 psi and a fuel lift of 24". A 1.3 L/hr. (.34 gal./hr.) fuel rate must be maintained at 5 Hz.

### Replacing the Fuel Pump

Replacement pumps are available through your source of supply. To replace the pulse pump follow these steps. Note orientation of pump before removing.

1. Disconnect the fuel lines from the inlet and outlet fittings.



**Figure 5-1. Fuel Pulse Pump Connections.**

2. Remove the hex. flange screws (securing pump to blower housing) and fuel pump.
3. Remove the vacuum line that connects the pump to the crankcase.
4. Install a new pump using the hex. flange screws.

**NOTE:** Make sure the orientation of the new pump is consistent with the removed pump. Internal damage may occur if installed incorrectly.

5. Connect vacuum line between pulse pump and crankcase. Route line so there are no low spots where oil could collect.
6. Tighten the hex. flange screws to **2.3 N·m (20 in. lb.)**.
7. Connect the fuel lines to the inlet and outlet fittings.

## Carburetor

### General

Engines in this series are equipped with fixed main jet carburetors. Most applications also utilize a fuel shut-off solenoid, which is installed in place of the fuel bowl retaining screw. All carburetors feature the self-relieving choke components shown in the exploded view on page 5.9. These carburetors include three main circuits which function as follows.

**Float Circuit:** Fuel level in the bowl is maintained by the float and fuel inlet needle. The buoyant force of the float stops fuel flow when the engine is at rest. When fuel is being consumed, the float will drop and fuel pressure will push the inlet needle away from the seat, allowing more fuel to enter the bowl. When demand ceases, the buoyant force of the float will again overcome the fuel pressure and stop the flow.

## Section 5 Fuel System and Governor

**Slow Circuit:** (Figure 5-2) At low speeds the engine operates only on the slow circuit. As a metered amount of air is drawn through the slow air bleed jet, fuel is drawn through the main jet and further metered through the slow jet. Air and fuel are mixed in the body of the slow jet and exit to the transfer port. From the transfer port this air fuel mixture is delivered to the idle progression chamber. From the idle progression chamber the air fuel mixture is metered through the idle port passage. At low idle when the vacuum signal is weak, the air fuel mixture is controlled by the metered idle fuel passage. This mixture is then mixed with the main body of air and delivered to the engine. As the throttle plate opening increases, greater amounts of air fuel mixture are drawn in through the fixed and metered idle progression holes. As the throttle plate opens further the vacuum signal becomes great enough so the main circuit begins to work.

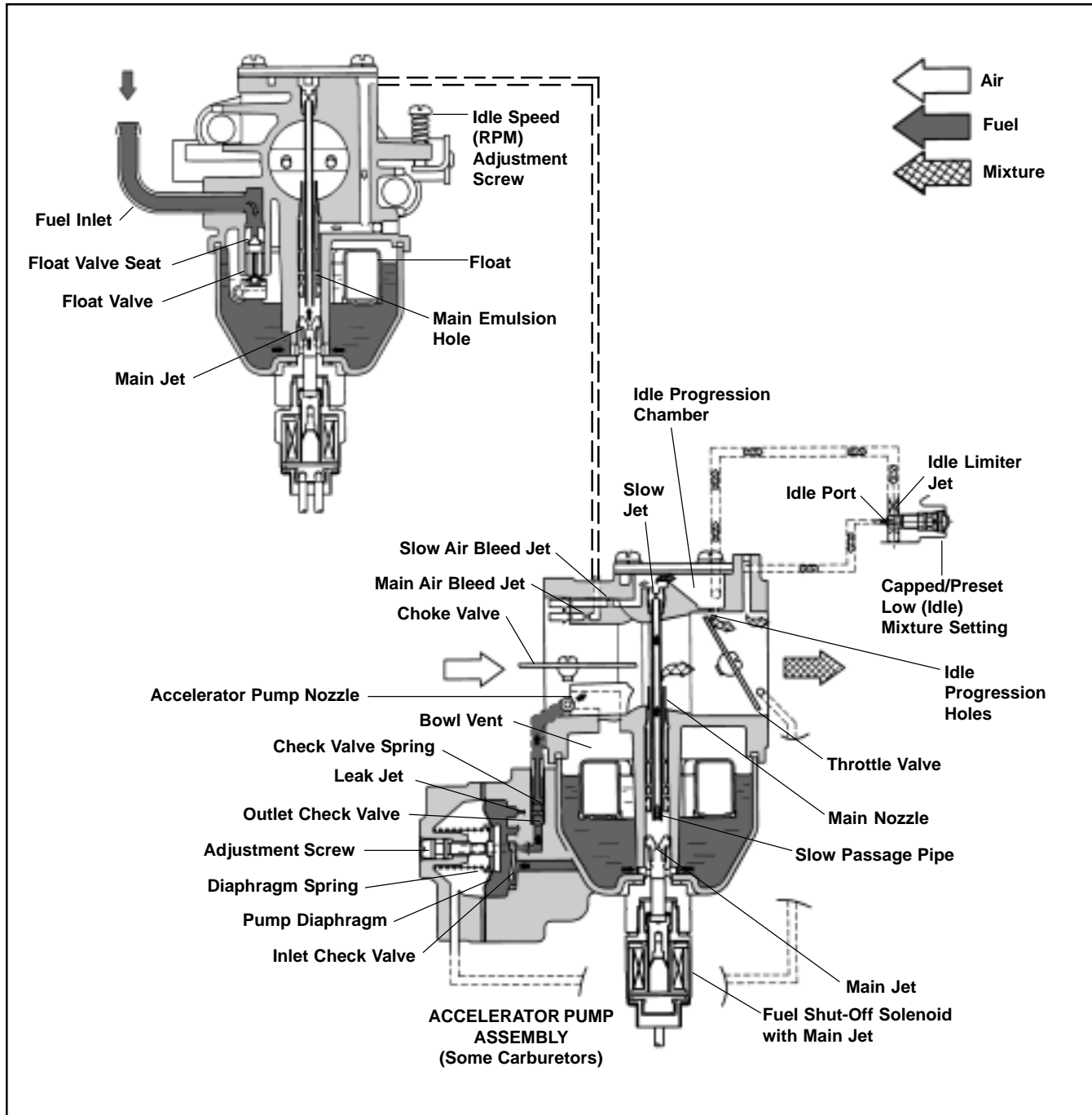
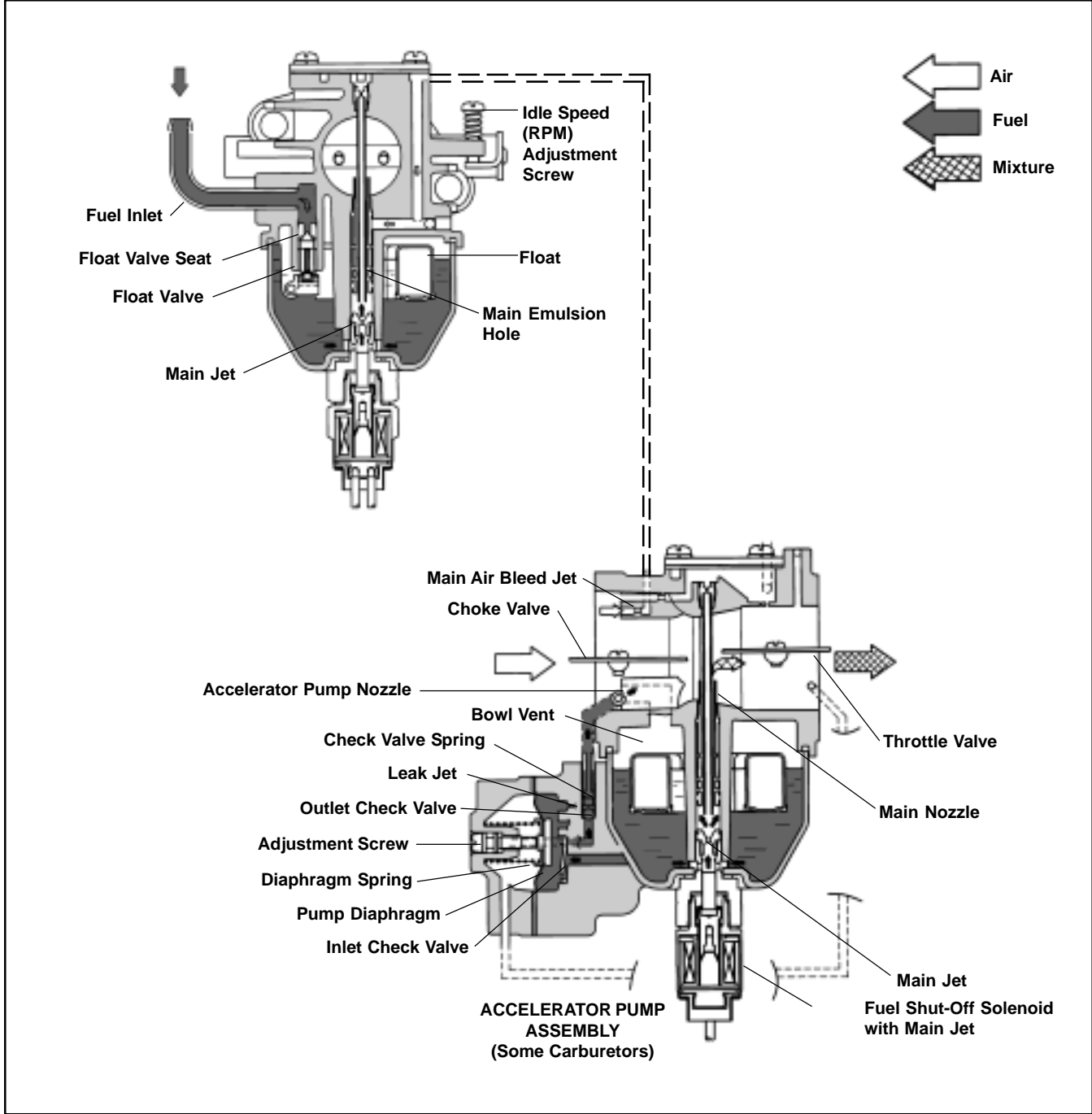


Figure 5-2. Slow Circuit.

Section 5  
Fuel System and Governor

**Main Circuit:** (Figure 5-3) At high speeds the engine operates mostly on the main circuit. As a metered amount of air is drawn through the main air bleed jet, fuel is drawn through the main jet. The air and fuel are mixed in the main nozzle and then enter the main body of air flow, where further mixing of the fuel and air takes place. This mixture is then delivered to the combustion chamber. The carburetor has a fixed main circuit. There is no adjustment feature present.



5

Figure 5-3. Main Circuit.

## Section 5

### Fuel System and Governor

#### Troubleshooting – Carburetor Related Causes

Condition	Possible Cause/Probable Remedy
1. Engine starts hard, runs roughly or stalls at idle speed.	1a. Low idle speed improperly adjusted. Adjust the low idle speed screw. b. Low idle fuel mixture circuit blocked/restricted. Clean carburetor as required.
2. Engine runs rich (indicated by black, sooty exhaust smoke, misfiring, loss of speed and power, governor hunting, or excessive throttle opening).	2a. Clogged air cleaner. Clean or replace. b. Choke partially closed during operation. Check the choke lever/linkage to ensure choke is operating properly. c. Float level too high. Separate fuel bowl from carburetor body. Free (if stuck), or replace float. d. Dirt under the fuel inlet needle. Remove needle; clean needle and seat and blow with compressed air. e. Bowl vent or air bleeds plugged. Clean vent, ports, and air bleeds. Blow out all passages with compressed air. f. Leaky, cracked, or damaged float. Submerge float to check for leaks.
3. Engine runs lean (indicated by misfiring, loss of speed and power, governor hunting, or excessive throttle opening).	3a. Float level too low. Separate fuel bowl from carburetor body. Free (if stuck), or replace float. b. Idle holes plugged; dirt in fuel delivery channels. Clean main fuel jet and all passages; blow out with compressed air.
4. Fuel leaks from carburetor.	4a. Float stuck. See Remedy 2d. b. Dirt under fuel inlet needle. See Remedy 2e. c. Bowl vents plugged. Blow out with compressed air. d. Carburetor bowl gasket leaks. Replace gasket.

#### Troubleshooting Checklist

When the engine starts hard, runs roughly or stalls at low idle speed, check the following areas before adjusting or disassembling the carburetor.

- Make sure the fuel tank is filled with clean, fresh gasoline.
- Make sure the fuel tank cap vent is not blocked and that it is operating properly.
- Make sure fuel is reaching the carburetor. This includes checking the fuel shut-off valve, fuel tank filter screen, in-line fuel filter, fuel lines and fuel pump for restrictions or faulty components as necessary.

- Make sure the air cleaner base and carburetor are securely fastened to the engine using gaskets in good condition.
- Make sure the air cleaner element is clean and all air cleaner components are fastened securely.
- Make sure the ignition system, governor system, exhaust system, and throttle and choke controls are operating properly.

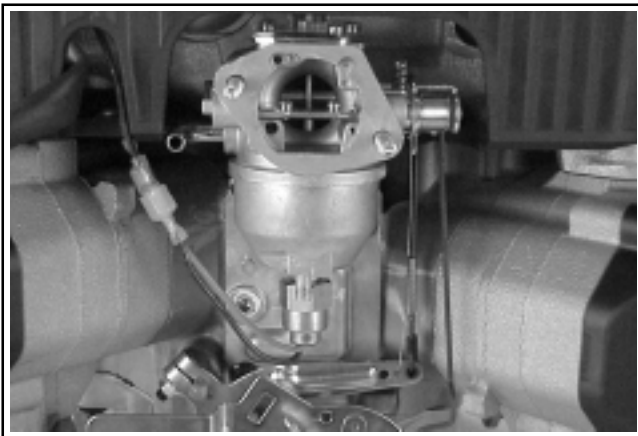
If the engine is hard-starting or runs roughly, or stalls at low idle speed, it may be necessary to service the carburetor.

### Fuel Shut-off Solenoid

Carburetors are equipped with a fuel shut-off solenoid, which also contains the main jet. The solenoid has a spring loaded pin which retracts when the key switch is “on”, allowing the engine to function normally. When the key switch is turned “off”, the pin extends and prevents fuel from entering the engine.

Below is a simple test made with the engine off, that can determine if the solenoid is functioning properly:

1. Shut off the fuel and remove the solenoid from the carburetor. When the solenoid is loosened and removed, gas will leak out of the carburetor. Have a container ready to catch the fuel.
2. Wipe the tip of the solenoid with a shop towel or blow it off with compressed air, to remove any remaining fuel. Take the solenoid to a location with good ventilation and no fuel vapors present. You will need a 12 volt power source that can be switched on and off.
3. Be sure the power source is switched off. Connect the negative power source lead to the black solenoid lead, and connect the positive power source lead to the red lead of the solenoid. Turn on the power source, while observing the pin in the center of the solenoid.
4. If the pin retracted when the power source was turned on, the solenoid is good. If the power source is turned off, the pin should return to its original position.



**Figure 5-4. Carburetor and Solenoid.**

### Adjustments

#### General

In compliance with government emission standards, the carburetor is calibrated to deliver the correct air-to-fuel mixture to the engine under all operating conditions. Both the low and the high speed mixture circuits are pre-established and cannot be adjusted. The low idle speed (RPM) is the only adjustment available.

NOTE: Low idle speed (RPM) adjustment should be made only after the engine has warmed up.

#### Adjusting Low Idle Speed (RPM) Setting

1. Start the engine and run at half throttle for 5 to 10 minutes to warm up. The engine must be warm before making final low idle speed (RPM) adjustment. Check that the throttle and choke plates can fully open.
2. Place the throttle control into the “idle” or “slow” position.
3. Set the low idle speed to **1200 RPM\* ( $\pm 75$  RPM)** by turning the low idle speed adjusting screw **in or out**. Check the speed using a tachometer.

\*NOTE: The actual low idle speed depends on the application. Refer to the equipment manufacturer’s recommendations. The low idle speed for basic engines is 1200 RPM. To ensure best results when setting the low idle fuel needle, the low idle speed should be 1200 RPM ( $\pm 75$  RPM).



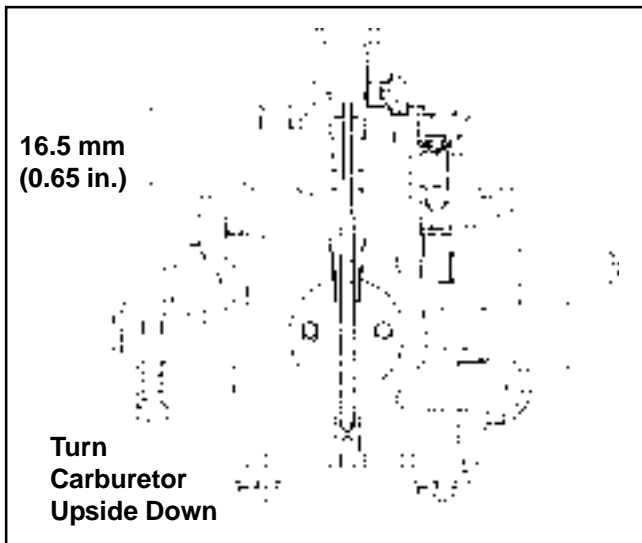
## Section 5

# Fuel System and Governor

### Float Replacement

If symptoms described in the carburetor troubleshooting guide indicate float level problems, remove the carburetor from the engine to check and/or replace the float. Use a Carburetor Overhaul Kit (see page 5.10) if float replacement is necessary.

1. Remove the upper blower housing and air intake components from the carburetor, as described in Section 4.
2. Disconnect the fuel inlet line from the carburetor.
3. Disconnect the governor, choke and throttle linkages from the carburetor.
4. Disconnect the lead wires from the carburetor solenoid.
5. Gently lift up on the lower blower housing directly above the carburetor and slide the carburetor off the mounting studs. Remove the fuel shut-off solenoid and drain any remaining fuel into a safe container. Remove the bowl from the carburetor body.



**Figure 5-5. Proper Float Level.**

6. Turn the carburetor upside down and check the level of the float, as shown in Figure 5-5. With the float needle valve fully seated, 16.5 mm (.65 in.) should be measured from the body to the float as indicated. Don't attempt to adjust by bending the tab. Install a new float if level is wrong.

7. Pull the float hinge pin and remove the float, with the inlet needle attached, to inspect these parts and the needle seat. If dirty, blow out with compressed air. Replace float components as needed with kit.
8. Using new bowl gaskets, reinstall and tighten the bowl with the fuel shut-off solenoid. Tighten to **5.1-6.2 N-m (45-55 in. lb.)**.
9. Reinstall carburetor to engine, reconnecting the fuel line, control linkages and solenoid leads. Reinstall the air intake components, and upper blower housing assembly. Retest operation.

### Disassembly

Use the following procedure to disassemble the carburetor after removing it from the engine. Refer to Figure 5-6 for identification of the component parts.

1. Remove the fuel shut-off solenoid assembly, then remove the fuel bowl and bowl gasket.
2. Pull the float hinge pin. Remove float with inlet needle attached.
3. Remove the set screws holding the throttle plate to the throttle shaft. Check for any burrs on the shaft and remove them. Pull the throttle shaft from the carburetor body.
5. Remove the set screws securing the choke plate to the choke shaft assembly. Check for any burrs on the shaft and remove them. Pull the choke shaft assembly out of the carburetor body. Disassemble self-relieving parts from shaft as needed.
6. Remove the three screws holding the passage cover to the body. Remove the cover and gasket.
7. Remove the slow speed adjusting needle and spring. Except for the slow jet nozzle, main jet, and emulsion tubes, which are considered non-serviceable, the carburetor is now completely disassembled and ready for thorough inspection and cleaning.

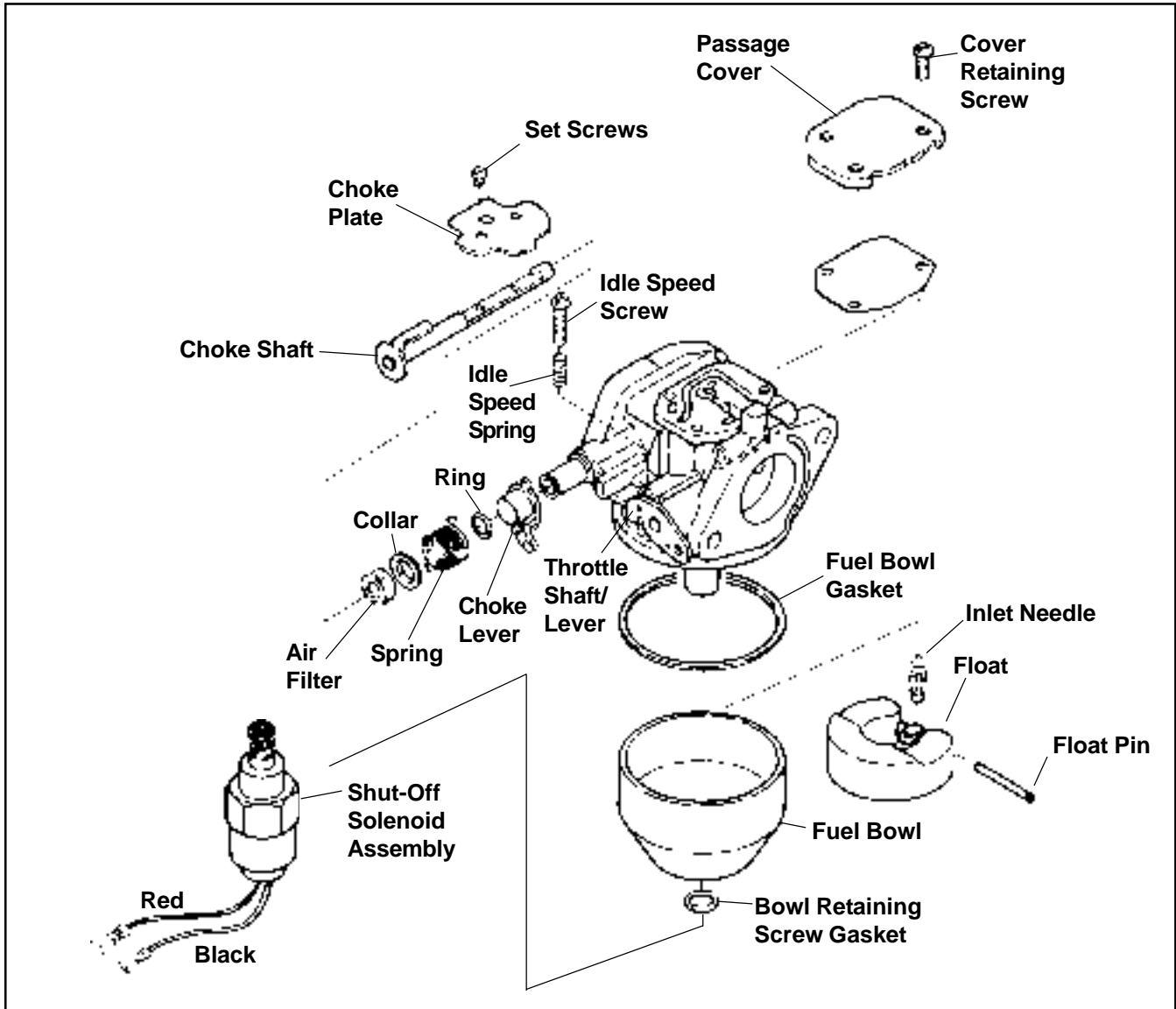


Figure 5-6. Carburetor - Exploded View.

**Inspection/Repair**

To clean vent ports, internal circuits etc., use a good commercially available carburetor solvent, such as Gumout™, and clean, dry compressed air to blow out internal channels and ports. Use a suitable shop rag to prevent debris from hitting someone.

Carefully inspect all components and replace those that are worn or damaged.

- Inspect the carburetor body for cracks, holes and other wear or damage.
- Inspect the float for cracks, holes, and missing or damaged float tab. Check the float hinge and pin for wear or damage.

- Inspect the fuel inlet needle and seat for wear or damage.
- The choke plate is spring loaded. Check to make sure it moves freely on the shaft.

Always use new gaskets when servicing or reinstalling carburetors. Repair kits are available which include new gaskets and other components. These kits are described on the next page.

Refer to the Parts Manual for the engine being serviced to ensure the correct repair kits and replacement parts are used. The Kohler part number is stamped on the top of the carburetor mounting flange.

## Section 5

### Fuel System and Governor

#### Overhaul Kit Contains:

Qty.	Description
1	Gasket, air cleaner base
1	Gasket, carburetor
1	Screw, throttle adjusting
1	Gasket, chamber screw
1	Screw, idle adjusting
1	Float
1	Pin, float
1	Inlet Needle
1	Gasket, float chamber
1	Spring, throttle adjusting screw
1	Spring, idle adjusting screw
1	Gasket, passage cover

#### Choke Repair Kit Contains:

Qty.	Description
1	Gasket, air cleaner base
1	Gasket, carburetor
2	Screw, valve set
1	Valve, choke
1	Filter, choke shaft
1	Spring, choke arm return
1	Ring, choke lever
1	Collar, choke
1	Shaft, choke assembly
1	Lever, choke assembly

#### Gasket Kit Contains:

Qty.	Description
1	Gasket, air cleaner base
1	Gasket, carburetor
1	Gasket, chamber screw
1	Gasket, float chamber
1	Gasket, passage cover

#### Solenoid Replacement Kit Contains:

Qty.	Description
1	Gasket, air cleaner base
1	Gasket, carburetor
1	Gasket, solenoid
1	Gasket, chamber screw
1	Holder, solenoid
1	Valve, solenoid

#### Reassembly Procedure

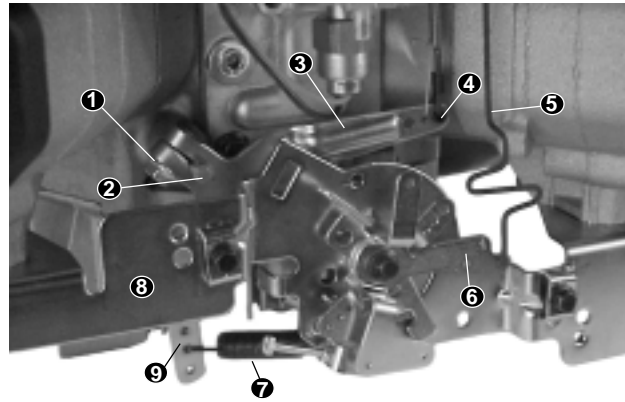
Reassembly is essentially the reverse of the disassembly procedure. Use new gaskets, springs, and adjusting screws as provided in the repair kit. Also use new carburetor and intake manifold gaskets.

#### Governor

##### General

The engine is equipped with a centrifugal flyweight mechanical governor. It is designed to hold the engine speed constant under changing load conditions. The governor gear/flyweight mechanism is mounted inside the oil pan and is driven off the gear on the camshaft. The governor works as follows:

- Centrifugal force acting on the rotating governor gear assembly causes the flyweights to move outward as speed increases. Governor spring tension moves them inward as speed decreases.
- As the flyweights move outward, they cause the regulating pin to move outward.
- The regulating pin contacts the tab on the cross shaft causing the shaft to rotate.
- One end of the cross shaft protrudes through the crankcase. The rotating action of the cross shaft is transmitted to the throttle lever of the carburetor through the external linkage. See Figure 5-7.
- When the engine is at rest, and the throttle is in the "fast" position, the tension of the governor spring holds the throttle plate open. When the engine is operating, the governor gear assembly is rotating. The force applied by the regulating pin against the cross shaft tends to close the throttle plate. The governor spring tension and the force applied by the regulating pin balance each other during operation, to maintain engine speed.
- When load is applied and the engine speed and governor gear speed decreases, the governor spring tension moves the governor arm to open the throttle plate wider. This allows more fuel into the engine, increasing engine speed. As speed reaches the governed setting, the governor spring tension and the force applied by the regulating pin will again offset each other to hold a steady engine speed.



1. Governor Lever Hex. Nut
2. Governor Cross Shaft
3. Governor Lever
4. Throttle Lever Linkage
5. Choke Linkage
6. Choke Actuating Lever
7. Governor Spring
8. Speed Control Bracket
9. Governor Lever (Holes for Sensitivity Adjustment)

Figure 5-7. Governor Controls and Linkage (External).

## Adjustments

### General

The governed speed setting is determined by the position of the throttle control. It can be variable or constant, depending on the engine application.

### Initial Adjustment

Make this adjustment whenever the governor lever is loosened or removed from the cross shaft. See Figure 5-7 and adjust as follows:

1. Make sure the throttle linkage is connected to the governor lever and the throttle lever on the carburetor.
2. Loosen the hex. nut holding the governor lever to the cross shaft.
3. Move the governor lever **towards** the carburetor as far as it will move (wide open throttle) and hold in position.

4. Insert a nail into the hole on the cross shaft and rotate the shaft **counterclockwise** as far as it will turn. Tighten hex. nut to **9.9 N·m (88 in. lb.)**.

5

### Sensitivity Adjustment

Governor sensitivity is adjusted by repositioning the governor spring in the holes on the governor lever. If speed surging occurs with a change in engine load, the governor is set too sensitive. If a big drop in speed occurs when normal load is applied, the governor should be set for greater sensitivity. See Figure 5-7 and adjust as follows:

1. To increase the sensitivity, move the spring closer to the governor cross shaft.
2. To decrease the sensitivity, move the spring away from the governor cross shaft.

## Section 5

### Fuel System and Governor

#### High Idle RPM Speed Adjustment (See Figure 5-8.)

1. With the engine running, move the throttle control to **fast**. Use a tachometer to check the RPM speed.
2. Loosen the lock nut on the high idle adjusting screw. Turn screw outward to decrease, or inward to increase RPM speed. Check RPM with a tachometer.

3. When the desired RPM speed is obtained, retighten the lock nut.

NOTE: Upon establishing the high idle RPM speed, check for a gap between the high idle control and the choke control. The gap may be greater, **but no less than** .5 mm (.02 in).

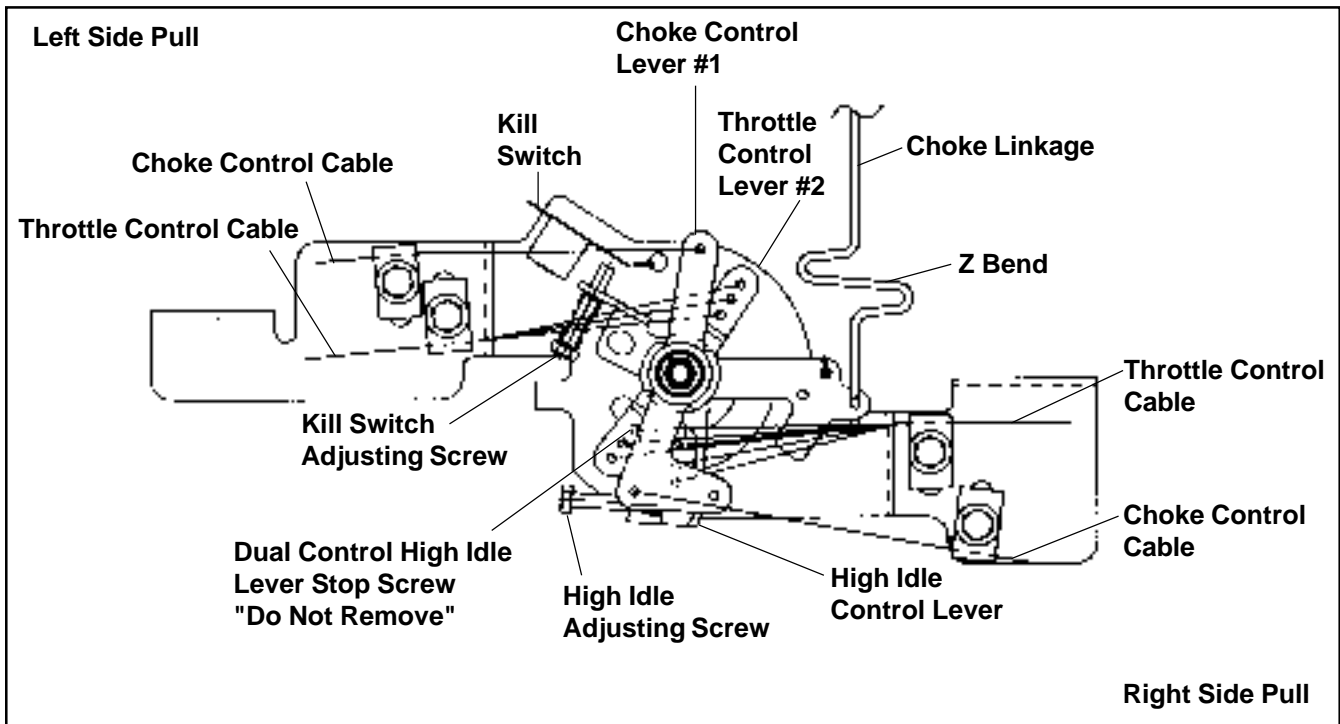


Figure 5-8. Governor Control Connections.

# Section 6

## Lubrication System

### General

This engine uses a full pressure lubrication system. This system delivers oil under pressure to the crankshaft, camshaft and connecting rod bearing surfaces. In addition to lubricating the bearing surfaces, the lubrication system supplies oil to the hydraulic valve lifters.

A high-efficiency gerotor pump is located in the oil pan. The oil pump maintains high oil flow and oil pressure, even at low speeds and high operating temperatures. A pressure relief valve in the oil pan limits the maximum pressure of the system.

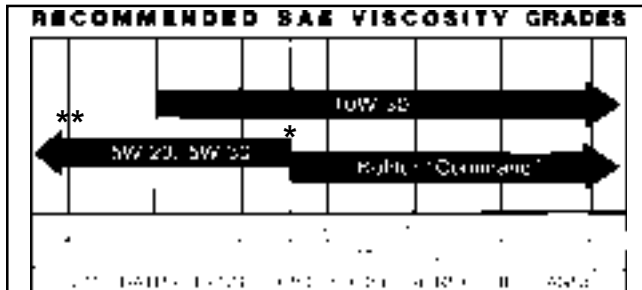
### Service

The oil pan must be removed to service the oil pickup, the pressure relief valve, and the oil pump. Refer to the appropriate procedures in Sections 9 and 10.

### Oil Recommendations

Using the proper type and weight of oil in the crankcase is extremely important; so is checking oil daily and changing the oil and filter regularly.

Use high-quality detergent oil of **API (American Petroleum Institute) service class SG, SH, SJ, or higher**. Select the viscosity based on the air temperature at the time of operation as shown in the following table.



\*Use of synthetic oil having 5W-20 or 5W-30 rating is acceptable, up to 4°C (40°F).  
 \*\*Synthetic oils will provide better starting in extreme cold below -23°C (-10°F).

NOTE: Using other than service class SG, SH, SJ, or higher oil or extending oil change intervals longer than recommended can cause engine damage.

A logo or symbol on oil containers identifies the API service class and SAE viscosity grade. See Figure 6-1.



Figure 6-1. Oil Container Logo.

The top portion of the symbol shows service class such as **API SERVICE CLASS SJ**. The symbol may show additional categories such as **SH, CC, or CD**. The center portion shows the viscosity grade such as **SAE 10W-30**. If the bottom portion shows "Energy Conserving," it means that oil is intended to improve fuel economy in passenger car engines.

### Checking Oil Level

The importance of checking and maintaining the proper oil level in the crankcase cannot be overemphasized. Check oil **BEFORE EACH USE** as follows:

1. Make sure the engine is stopped, level, and cool so the oil has had time to drain into the sump.
2. Clean the area around the oil fill cap/dipstick before removing it. This will help to keep dirt, grass clippings, etc., out of the engine.

## Section 6 Lubrication System

- Unthread and remove the oil fill cap/dipstick; wipe oil off. Reinsert the dipstick into the tube and rest the cap on the tube. Do not thread the cap onto the tube. See Figure 6-2.



Figure 6-2. Oil Fill Cap/Dipstick.

- Remove dipstick and check oil level. The level should be between the FULL and ADD marks. If low, add oil of proper type up to the FULL mark. Reinstall oil fill cap/dipstick and thread tight.

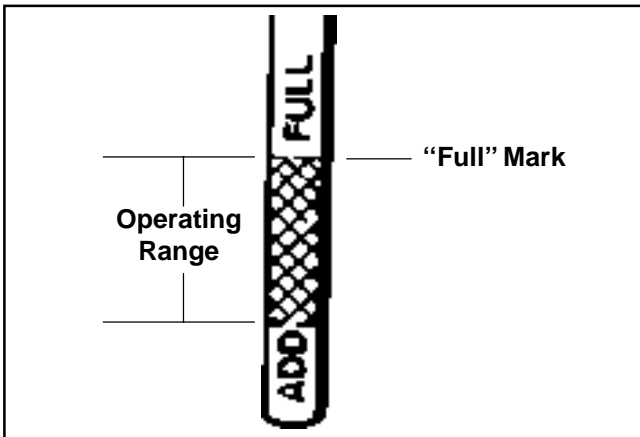


Figure 6-3. Oil Level Marks on Dipstick.

NOTE: To prevent extensive engine wear or damage, always maintain the proper oil level in the crankcase. Never operate the engine with the oil level below the "ADD" mark or above the "FULL" mark on the dipstick.

### Changing Oil and Oil Filter

Change oil and oil filter after **every 200 hours or annually, whichever comes first** (more often under severe conditions). Refill with service class SG, SH, SJ or higher oil, as specified in the "Viscosity Grades" table on previous page. Always use a genuine Kohler oil filter. Use chart below to determine part number to order.

Oil Filter Part No.	Length
277233-S	5"
12 050 01-S	2-1/2"
52 050 02-S	3-3/8"

Change the oil while the engine is still warm. The oil will flow freely and carry away more impurities. Make sure the engine is level when filling or checking oil.

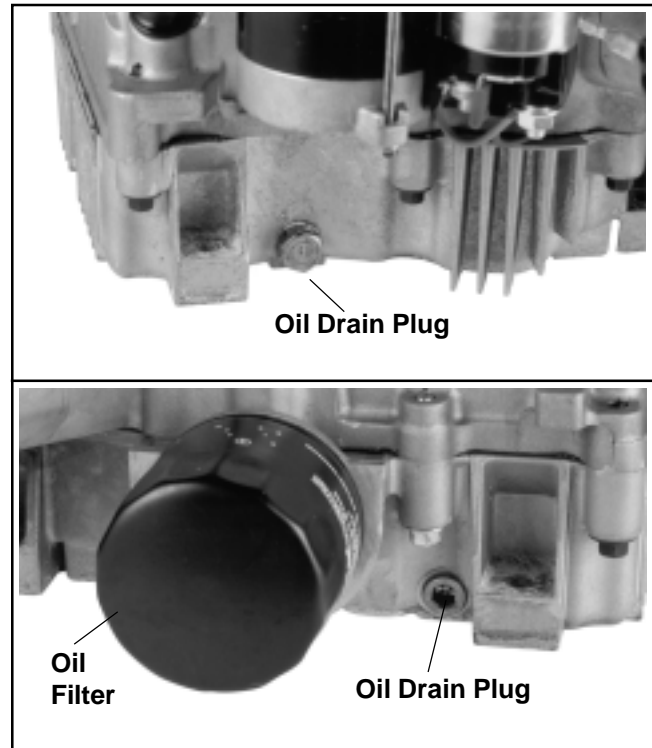


Figure 6-4. Oil Drain Plugs and Oil Filter.

Change the oil and oil filter as follows (See Figure 6-4.):

- To keep dirt, debris, etc., out of the engine, clean the area around the oil fill cap/dipstick before removing it.
- Remove one of the oil drain plugs and the oil fill cap/dipstick. Be sure to allow ample time for complete drainage.

3. Before removing the oil filter, clean the surrounding area to keep dirt and debris out of the engine. Remove the old filter and wipe/clean the surface where the filter mounts.
4. Reinstall the drain plug. Make sure it is tightened to **13.6 N-m (10 ft. lb.)**.
5. Place a new oil filter in a shallow pan with the open end up. Pour new oil, of the proper type, in through the threaded center hole. Stop pouring when the oil reaches the bottom of the threads. Allow a minute or two for the oil to be absorbed by the filter material.
6. Put a drop of oil on your fingertip and wipe it on the rubber gasket.
7. Install the new oil filter to the filter adapter. Turn the oil filter clockwise until the rubber gasket contacts the surface, then tighten the filter an additional 2/3-1 turn.
8. Fill the crankcase with new oil of the proper type, to the "FULL" mark on the dipstick. Refer to "Oil Type" and "Check Oil Level" on pages 6.1 and 6.2. Always check the level with the dipstick before adding more oil.
9. Reinstall the oil fill cap/dipstick and tighten securely by turning to the right.

**NOTE:** To prevent extensive engine wear or damage, always maintain the proper oil level in the crankcase. Never operate the engine with the oil level below the "ADD" mark or above the "FULL" mark on the dipstick.

### Angle of Operation

This engine will operate continuously at angles up to 20°. Check oil level to assure crankcase oil level is at the "FULL" mark on the dipstick.

Refer to the operating instructions of the equipment this engine powers. Because of equipment design or application, there may be more stringent restrictions regarding the angle of operation.

**NOTE:** Do not operate this engine continuously at angles exceeding 20° in any direction. Engine damage could result from insufficient lubrication.

## Oil Sentry™

### General

Some engines are equipped with an optional Oil Sentry™ oil pressure switch monitor. If the oil pressure decreases below an acceptable level, the Oil Sentry™ will either shut off the engine or activate a warning signal, depending on the application.

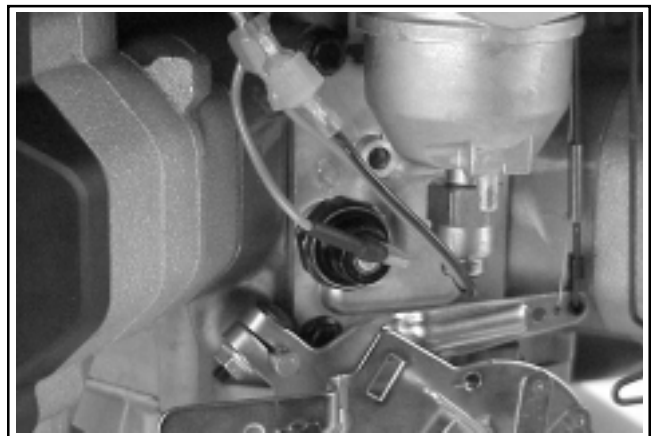
The pressure switch is designed to break contact as the oil pressure increases, and make contact as the oil pressure decreases. At oil pressure above approximately 3.0/5.0 psig, the switch contacts open. Below this pressure, the switch contacts close.

On stationary or unattended applications (pumps, generators, etc.), the pressure switch can be used to ground the ignition module to stop the engine. On vehicular applications (lawn tractors, mowers, etc.) the pressure switch can only be used to activate a warning light or signal.

**NOTE:** Make sure the oil level is checked BEFORE EACH USE and is maintained up to the "FULL" mark on the dipstick. This includes engines equipped with Oil Sentry™.

### Installation

The Oil Sentry™ pressure switch is installed on the breather cover. See Figure 6-5.



**Figure 6-5. Oil Sentry™ Location.**

On engines not equipped with Oil Sentry™ the installation hole is sealed with a 1/8-27 N.P.T.F. pipe plug.



## Section 6

### Lubrication System

To install the switch, follow these steps:

1. Apply **Loctite® No. 592 Pipe Sealant with Teflon®** (or equivalent) to the threads of the switch.
2. Install the switch into the tapped hole in the breather cover. See Figure 6-5.
3. Torque the switch to **4.5 N·m (40 in. lb.)**.

#### Testing

Compressed air, a pressure regulator, pressure gauge and a continuity tester are required to test the switch.

1. Connect the continuity tester to the blade terminal and the metal case of the switch. With **0 psig** pressure applied to the switch, the tester should indicate **continuity (switch closed)**.
2. Gradually increase the pressure to the switch. As pressure increases through the range of **3.0/5.0 psig**, the tester should indicate a change to **no continuity (switch open)**. The switch should remain open as the pressure is increased to **90 psig maximum**.
3. Gradually decrease the pressure through the range of **3.0/5.0 psig**. The tester should indicate a change to **continuity (switch closed) down to 0 psig**.
4. Replace the switch if it does not operate as specified.

#### Crankcase Breather System

The crankcase breather system is a necessary complement to the lubrication system. To help prevent the engine oil from weeping out past shafts, seals, and gaskets during operation, it is desirable to have a low vacuum inside the crankcase. A typical crankcase breather system incorporates a simple one-way valve to provide the desired vacuum.

#### Breather Design and Function

The breather system on these engines is designed to serve two functions; prevent excess oil from accumulating in the rocker arm chambers, and maintain the desired vacuum in the crankcase. The system utilizes a spring steel reed and stop mounted in each bank of the crankcase, between the lifter bores. See Figure 6-6.

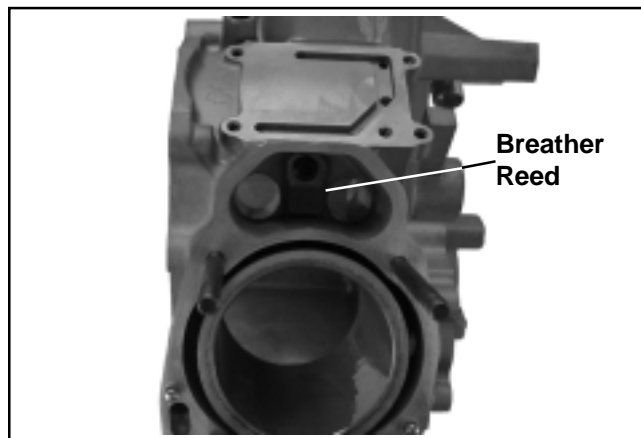


Figure 6-6. Reed/Breather Assembly in Crankcase.

When the pistons move downward, crankcase air is pushed past the reeds into the cylinder head cavities. On the #2 cylinder, the upper end of the head is completely sealed by the valve cover, so a low, positive pressure is created in the head cavity. The valve cover on the #1 cylinder has an integral breather assembly to vent the air entering that head cavity. The breather inlet hole (see Figure 6-7) is positioned so most of the oil mist has already dropped out before the air enters the breather. A series of baffles and a screen separate the remaining oil as the air moves through the inside. A hose connects the breather outlet to the air cleaner base. The vented breather air is mixed with the combustion air, on its way to the combustion chamber.

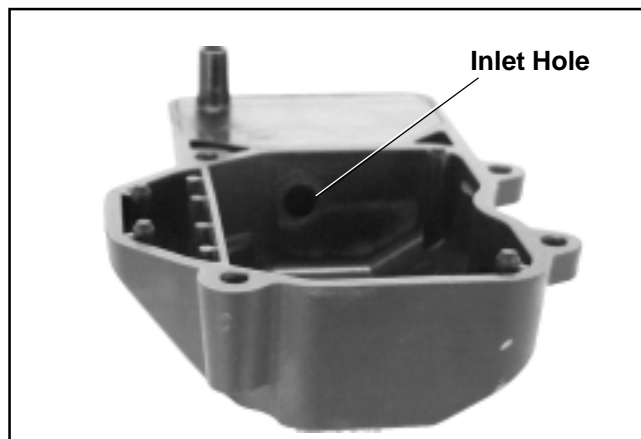


Figure 6-7. Inlet Hole in #1 Valve Cover.

The upward travel of the pistons closes the reeds and creates a low vacuum in the lower crankcase. The combination of low pressure above and low vacuum below forces any accumulated oil out of the #2 head area into the crankcase. On the #1 side, atmospheric pressure above and vacuum below, draws any oil toward the crankcase.

# Section 7

## Cooling System



**WARNING: Explosive release of fluids from pressurized cooling system can cause serious burns!**

*When it is necessary to open cooling system at radiator cap, shut off engine and remove filler cap **only when cool enough to touch with bare hands**. Slowly loosen cap to first stop to relieve pressure before removing completely.*

This section covers the operation and servicing of the liquid cooling system.

### Cooling System Components

The cooling system consists of the following components:

- Patented Circular Radiator
- Hoses
- Patented Coolant Pump with Rubber Drive Belt
- Thermostat
- Intake Manifold with Thermostat Housing
- Radiator Cap
- Radial Cooling Fan
- Overflow Reservoir
- Crankcase and Heads with Integral Cooling Passages



Figure 7-1. Cooling System.

### Operation

The engine coolant is pumped through the cooling system by a pump, belt-driven off the camshaft. The coolant coming out of the pump is divided, and moves simultaneously through separate parallel circuits within each head and the corresponding sides of the crankcase. As the coolant moves through these passages in the engine, it absorbs heat from the engine parts. After traveling through the engine, the coolant from the two separate circuits is united and moves through the intake manifold to the lower side of the thermostat. During warm-up, the thermostat is closed, preventing circulation through the radiators. The coolant circulates through the engine only and is returned to the pump via the bypass hose. When engine heat brings the coolant up to a temperature of 79.4° C (175° F), the thermostat will begin to open, allowing coolant to circulate through the radiators. The thermostat is completely open at 90.5° C (195° F), allowing full coolant flow through the radiators. The rotation of the cooling fan, attached to the flywheel, draws in ambient air and blows it through the radiators to carry away the heat being dissipated from the coolant. After getting “cooled” in the radiator, the coolant is drawn into the pump from the hoses connected to the bottom of each of the radiators and circulation starts all over again.

## Section 7

# Cooling System

### Coolant Recommendations

Use equal parts of ethylene glycol (anti-freeze) and water only. Distilled or deionized water is recommended, especially in areas where the water contains a high mineral content. Propylene glycol based anti-freeze is not recommended.

This mixture will provide protection from -37° C (-34° F) to 108° C (226° F). For protection and use outside the indicated temperature limits, follow the anti-freeze manufacturer's instructions on the container, but do not exceed 70% anti-freeze.

DO NOT use anti-freeze with stop-leak additive(s), or put any other additives in the cooling system.

### Cooling System Maintenance and Service

#### Maintenance

Maintaining the correct coolant level and cleaning any debris accumulation from the inlet screen and the radiator surfaces, is critical to insuring long life, proper system performance, and preventing overheating. To ensure proper air circulation, make sure the grass screen, radiators, cooling fins, and other external surfaces of the engine are kept clean **at all times**. Check the coolant level and clean away any debris accumulation daily or before each use. At the same time inspect the hoses and all system connections for signs of leakage.

#### Servicing

Every **100 hours** of operation (more often under extremely dusty, dirty conditions), remove the upper blower housing. Clean the air intake screen as instructed in Section 4 and clean the external surfaces of the engine. Clean the cooling fins of the radiator with a soft brush or blow out using clean compressed air. See Figure 7-2. To avoid damaging the cooling fins, **do not** use a pressure washer. Make sure all parts are reinstalled before starting.

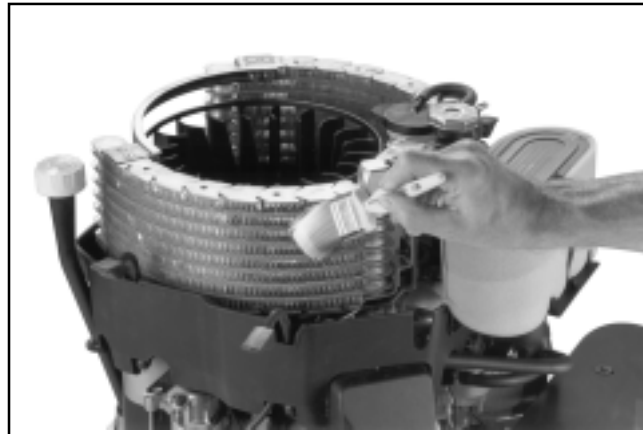


Figure 7-2. Cleaning Radiator Cooling Fins.

Engine coolant should be changed every **two years or 1000 hours, whichever comes first**. When changing the engine coolant, the system should also be flushed, to remove any contaminants left behind during draining. Following are recommended procedures for checking, draining, flushing, and filling the cooling system.

#### Checking Coolant Level

The coolant level should be checked at the overflow reservoir, located under the upper blower housing assembly.

1. Unhook the retaining straps and remove the upper blower housing and screen assembly. See Figure 7-3.

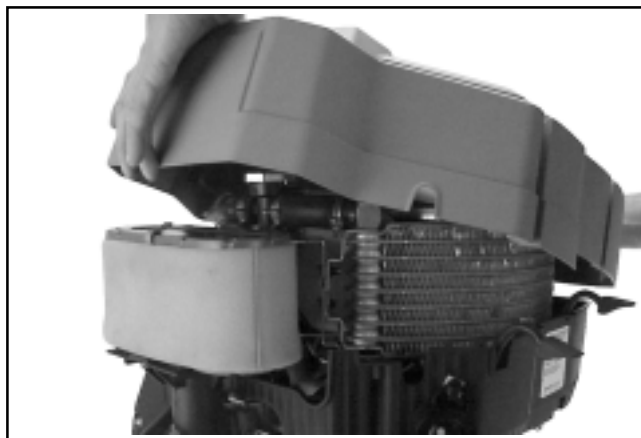


Figure 7-3. Removing Upper Blower Housing and Screen Assembly.

2. Check the coolant level in the overflow reservoir. Coolant level should be between the "Max. Level" and "Min. Level" marks on the reservoir. See Figure 7-4. **Do not** operate the engine with the coolant level below the "Min. Level" mark. Add coolant to the overflow reservoir as required.



Figure 7-4. Coolant Levels on Reservoir.

NOTE: **Do not** operate the engine without coolant in the system. **Do not** remove the radiator cap when hot. Engine coolant is hot and under pressure and can cause severe burns. To prevent engine overheating and damage, **do not** exceed more than 70% anti-freeze in the cooling system.

### Draining Cooling System

1. Stop the engine and let the engine cool sufficiently.
2. Unhook the retainer straps, and remove the upper blower housing and screen assembly.
3. When it is cool enough to touch with bare hands, slowly remove the radiator cap.
4. Locate and remove the coolant drain plug in the lower side of both cylinder heads. See Figure 7-5.

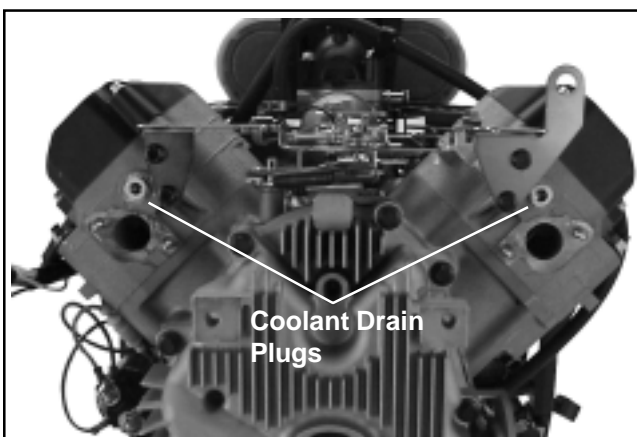


Figure 7-5. Location of Coolant Drain Plugs.

NOTE: To avoid thread damage, do not attempt to remove plugs when engine is hot.

Drain the coolant into a suitable container. After the coolant has drained, apply pipe sealant with Teflon® (not Teflon tape) to the threads and reinstall the plugs. Torque the plugs to **13.5 N·m (120 in. lb.)**. Some early production engines contained steel plugs. Always use brass (soft) plugs (Kohler Part. No. 66 139 01-S) when service is performed.

5. Loosen the two screws holding the overflow reservoir retainer bracket to the radiators. See Figure 7-6.



Figure 7-6. Loosening Retainer Bracket Mounting Screws.

6. Remove the reservoir cap. Carefully lift the top bracket up slightly, and pull the reservoir out between the bracket and fan. See Figures 7-7 and 7-8. Pour out the contents of the reservoir and wash or clean as required. Dispose of all the old coolant properly, according to local regulations.



Figure 7-7. Tipping Bracket Away after Removing Reservoir Cap.

## Section 7

### Cooling System

---



Figure 7-8. Removing Overflow Reservoir.

7. Reinstall the reservoir, inserting the two lower molded protrusions into the mounting holes in the lower support bracket. Engage the top bracket around the upper protrusion of the reservoir. Hold it in this position and torque the two screws to **7.3 N-m (65 in. lb.)**.
8. Reinstall the reservoir cap. Do not kink/pinch the hose.
9. Flush the cooling system (See Flushing Cooling System).

#### Flushing Cooling System

NOTE: To prevent engine damage, **do not** pour water into a hot engine. **Do not** operate engine without coolant.

With system properly drained:

1. Fill the cooling system with clean water and a cooling system cleaner recommended for aluminum engines. Follow the directions on the container.
2. Reinstall and tighten the radiator cap.
3. Reinstall the upper blower housing assembly and secure with the retaining straps.
4. Start and run the engine five minutes, or until it reaches operating temperature.
5. Remove the upper blower housing and drain the cooling system immediately, before contaminants settle (refer to "Draining Cooling System").

6. Fill the cooling system (See Filling the Cooling System).
7. Reinstall the upper blower housing and screen assembly.

#### Filling Cooling System

NOTE: To prevent engine damage, **do not** use anti-freeze mixture greater than 70% ethylene glycol in the cooling system. **Do not** use anti-freeze with stop-leak additive(s) or mix/add other additives to the cooling system. Use only ethylene glycol anti-freeze.

#### Cooling system capacity is approximately 1.4 liters (1.47 qts.)

1. Unhook the retainer straps, and remove the upper blower housing and screen assembly.
2. Check the condition of cooling system hoses, clamps, and associated components. Replace as required.
3. Mix 50% ethylene glycol with 50% distilled or deionized water (See Coolant Recommendation). For extremely cold temperature applications or protection outside the limits listed in the Coolant Recommendation Section, refer to the anti-freeze manufacturer's instructions on the container.
4. Fill the cooling system through neck for radiator cap with the coolant mix, allow coolant to drain into the lower areas. Fill the overflow reservoir midway between the "Min. Level" and "Max. Level" marks, then install the radiator and reservoir caps.
5. Install the upper blower housing and screen assembly. Start engine, run for five minutes and let cool.
6. Remove the blower housing and recheck coolant level in reservoir. Coolant level should be between the "Max. Level" and "Min. Level" marks. See Figure 7-4. Add coolant if required.
7. Reinstall the upper blower housing and screen assembly.

### Hoses and Tubes

Hoses and tubes are used to connect the components within the cooling system. To guard against coolant loss and hose failure, the hoses, tubes and their connections should be checked regularly for leaks or damage. Loss of coolant can result in serious engine damage. Over time, engine vibration can affect hose/joint connections, and the hoses themselves can be affected by heat and the coolant. Swelling, hardening, and/or deterioration can occur depending on the operating environment involved. Deterioration usually takes place more rapidly from the inside, making outside inspections incomplete and not always dependable. Regular outside inspection and careful inside inspection whenever connections are opened, can minimize a possible “in-service” problem.

Use new clamps whenever replacing a hose or a joint connection is opened, to assure proper retention and avoid leakage as a result of insufficient tension.

When making hose connections, a light coating of rubber lubricant will make assembly easier.

### Thermostat Testing and Servicing

The thermostat is mounted in the intake manifold, beneath the thermostat housing. See Figure 7-9. It controls the rapid warm-up and operating temperature of the engine. If a problem is encountered which is thought to be the fault of the thermostat, it can be checked to determine its operating condition. Before removing and testing the thermostat, make sure all other possible causes such as debris accumulation, obstruction, leaks, coolant level, and damaged components are eliminated as possible causes.



Figure 7-9. Intake/Thermostat.

### To Test

Remove the thermostat from the system. Hang or suspend the thermostat by its frame in a container of water, so the thermostat does not touch the bottom of the container. Heat the water and measure the temperature (an oven thermometer can be used). The spring-loaded valve of the thermostat should begin to open at 79.4° C (175° F), and can be completely open at 90° C (195° F). If the valve opens at a temperature more than 10 degrees below the specified opening or fails to open at a temperature 10 to 15 degrees above the specified opening, the thermostat should be replaced. If the valve in the thermostat can be moved or pushed off its seat with a slight effort when the thermostat is cold, the unit may be considered defective and should be replaced. The thermostat should be replaced if operation is found to be questionable or faulty.

### Installation

1. Thoroughly clean the sealing surfaces of the intake manifold and thermostat housing with an aerosol gasket remover. Make sure the sealing surfaces are clean and free of nicks or damage. Make sure the notch in the intake manifold is clean.
2. Install a new thermostat into the intake manifold, so the larger spring end is down into the well of the intake manifold. Position a new thermostat gasket on the intake manifold.
3. Install the thermostat housing so the outlet faces away from the mounting surfaces of the intake manifold.
4. Install and torque the two hex. flange screws to **9.9 N·m (88 in. lb.)**.
5. Reconnect the radiator hose and secure with the hose clamp, if separated previously.

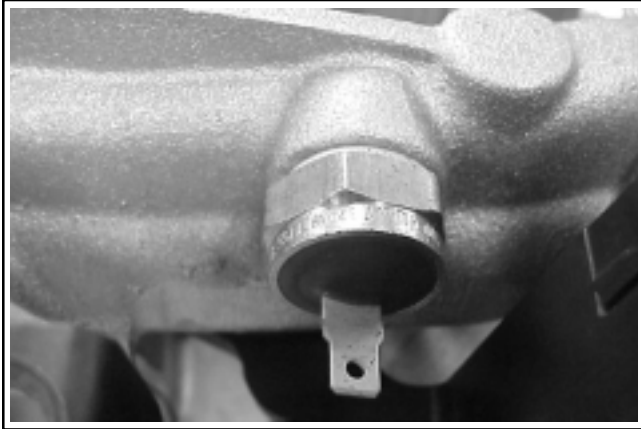
## Section 7

# Cooling System

---

### High Temperature Sensor

A high temperature sensor may be mounted in the intake manifold and is used to activate a warning light, audible alarm, or kill the engine (depending on the application), if the safe operating temperature is exceeded. The sensor is a “normally open” switch which completes a circuit, when the coolant temperature reaches the rated temperature limit of the switch. For AEGIS™ engines the temperature sensor limit is 123.8° C (255° F).



**Figure 7-10. Temperature Switch.**

If the warning device activates or the engine kills, indicating an excessive operating temperature check the following:

1. Make sure all air intake and cooling surfaces are clean and free of debris accumulation.
2. After the engine has sufficiently cooled, check the coolant level in the system to make sure it is not low, or improperly mixed.
3. Check cooling system for leaks.
4. Check the thermostat, and pressure test the radiator cap.
5. Make sure the water pump and the drive belt are operational.
6. Check and inspect the wiring from the sensor for shorting or damage.

If none of those are found to be the cause do the following:

1. Drain coolant from the system, so the level is lower than the installed position of the temperature sensor.
2. Remove and replace the temperature sensor. Use pipe sealant with Teflon® on the threads.

### Cooling System Leakage Test

A pressure test of the cooling system can be performed as a relatively simple means of determining whether the cooling system may contain a leak. A pump/pressure type cooling system tester with the appropriate adapter may be used to check the cooling system and the radiator cap. A typical tester and adapter is shown in Figure 7-11.



**Figure 7-11. A Typical Tester and Adapter.**

#### Test Instructions

1. With the engine cool, carefully remove the radiator cap (see Pressure Radiator Cap Section). Make sure all parts as well as the seating surfaces of the cap and adapter are clean. Install the cap on the corresponding adapter and make sure it is completely seated. Install the adapter onto the tester and lock in place. See Figure 7-12.



Figure 7-12. Adapter Installed onto the Tester.

2. Pressurize the tester to 15 psi.
3. Observe the indicated pressure. It should hold steady and not decrease or leak down.

If leakage is detected, the cap should be replaced. If the tester pressure is increased to 16 psi, or above, the cap should then “bleed off” this excess pressure.

4. Install and lock the system adapter and tester onto the neck of the cooling system. Pressurize the tester to 14-15 psi. See Figure 7-13.



Figure 7-13. Adapter and Tester Installed.

5. Observe the system pressure on the gauge.

### Gauge holds steady pressure

If the gauge needle holds steady, there should be no serious leaks in the system. It is recommended that all connections be checked for overall condition anyway, using a flashlight.

### Pressure drops slowly

If the gauge needle drops slowly it indicates the presence of a small leak or seepage. Check all components and connections for signs of leakage. Check the condition of radiator hoses. If they swell excessively while testing the system, they may be weak and should be replaced.

### Pressure drops quickly

A steady drop or loss of pressure indicates serious leakage is occurring within the system, which must be located and corrected before the engine is returned to service.

If a pressure loss is noted:

1. With pressure on the system, apply a soap/water solution and check all joint connections, hoses, and cooling system components for external leakage. Repair or replace as required.
2. Remove the dipstick and check the appearance of the oil in the crankcase. Another method would be to remove an oil drain plug and drain a small amount of oil for inspection. A milky or an opaque color, similar to chocolate milk, indicates the presence of engine coolant in the oil. Check for a blown head gasket (step 3 below) or a possible crack or internal leakage from the water jacket.
3. Remove the spark plugs. Apply 14-15 lbs. of pressure and listen/inspect for internal coolant leakage into the cylinder/combustion chambers. This can denote a head gasket failure/leak. If required, further test by performing a “Cylinder Leakdown Test” as described in Section 3.



**Section 7**  
**Cooling System**

---

## Section 8

# Electrical System and Components

This section covers the operation, service and repair of the electrical system components. Systems and components covered in this section are:

- Spark Plugs
- Battery and Charging System
- Electronic CD Ignition System
- Electric Starter

### Spark Plugs

Engine misfire or starting problems are often caused by a spark plug that has improper gap or is in poor condition.

The engine is equipped with the following spark plugs:

**Type:** The standard spark plug is a Champion® RC14YC (Kohler Part No. 66 132 01-S). Equivalent alternate brand plugs can also be used.

**Gap:** 0.76 mm (0.030 in.)

**Thread Size:** 14 mm

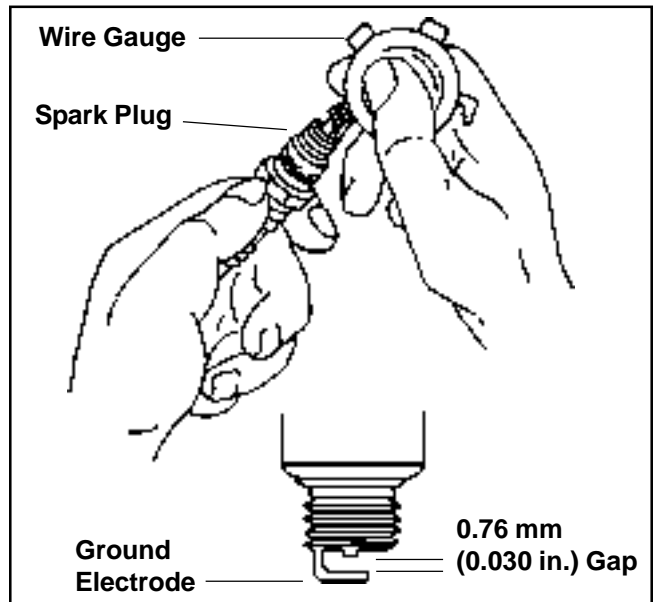
**Reach:** 19.1 mm (3/4 in.)

**Hex. Size:** 16 mm (5/8 in.)

### Spark Plug Service

Annually or every **200 hours** of operation (whichever comes first), remove the spark plugs, check condition, and reset the gap or replace with new spark plugs as necessary. Every **500 hours** of operation, replace the spark plugs. To service the spark plugs perform the following steps:

1. Before removing each spark plug, clean the area around the base of the plug to keep dirt and debris out of the engine.
  2. Remove the plug and check its condition. See "Inspection" following this procedure. Replace the plug if necessary.
- NOTE:** Do not clean spark plug in a machine using abrasive grit. Some grit could remain in the spark plug and enter the engine causing extensive wear and damage.
3. Check the gap using a wire feeler gauge. Adjust the gap to **0.76 mm (0.030 in.)** by carefully bending the ground electrode. See Figure 8-1.
  4. Reinstall the spark plug into the cylinder head and tighten to **24.4-29.8 N·m (18-22 ft. lb.)**.



**Figure 8-1. Servicing Spark Plug.**

## Section 8

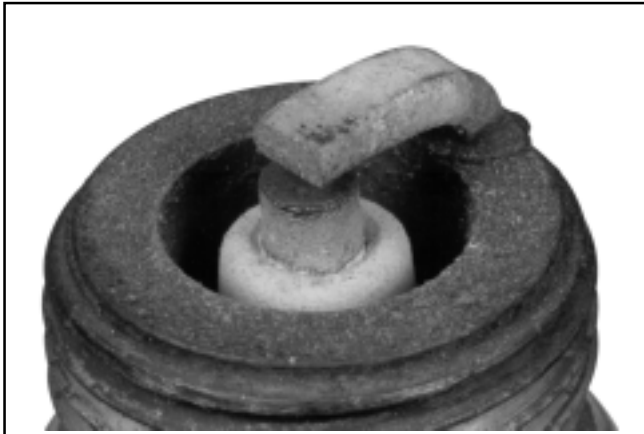
### Electrical System and Components

---

#### Inspection

Inspect each spark plug as it is removed from the cylinder head. The deposits on the tip can be an indication of the general condition of the engine and/or adverse operating conditions.

Normal and fouled plugs are shown in the following photos:



**Normal:** A plug taken from an engine operating under normal conditions will have light tan or gray colored deposits. If the center electrode is not worn, a plug in this condition could be set to the proper gap and reused.



**Carbon Fouled:** Soft, sooty, black deposits indicate incomplete combustion caused by a restricted air cleaner, overrich carburetion, weak ignition, or poor compression.



**Worn:** On a worn plug, the center electrode will be rounded and the gap will be greater than the specified gap. Replace a worn spark plug immediately.



**Wet Fouled:** A wet plug is caused by excess fuel or oil in the combustion chamber. Excess fuel could be caused by a restricted air cleaner, a carburetor problem, or operating the engine with too much choke. Oil in the combustion chamber is usually caused by a restricted air cleaner, a breather problem, worn piston rings or valve guides.



**Overheated:** Chalky, white deposits indicate very high combustion temperatures. This condition is usually accompanied by excessive gap erosion. Lean carburetor settings, an intake air leak, or incorrect spark timing are normal causes for high combustion temperatures.

## Battery

### General

A 12 volt battery with a minimum of 400 cold cranking amps should be sufficient for cranking. The actual cold cranking requirement depends on engine size, application and starting temperatures. Cranking requirements increase as temperatures decrease and battery capacity shrinks. Refer to the operating instructions of the equipment this engine powers for specific battery requirements.

If the battery charge is not sufficient to turn over the engine, recharge the battery.

### Battery Maintenance

Regular maintenance is necessary to prolong battery life.



### **WARNING: Explosive Gas!**

*Batteries produce explosive hydrogen gas while being charged. To prevent a fire or explosion, charge batteries only in well ventilated areas. Keep sources of ignition away from the battery at all times. Keep batteries out of the reach of children. Remove all jewelry when servicing batteries.*

*Before disconnecting the negative (-) ground cable, make sure all switches are OFF. If ON, a spark will occur at the ground cable terminal which could cause an explosion if hydrogen gas or gasoline vapors are present.*

1. Regularly check the level of electrolyte. Add distilled water as necessary to maintain the recommended level.

**NOTE:** Do not overfill the battery. Poor performance or early failure due to loss of electrolyte will result.

2. Keep the cables, terminals, and external surfaces of the battery clean. A build-up of corrosive acid or grime on the external surfaces can cause the battery to self-discharge. Self-discharge occurs rapidly when moisture is present.
3. Wash the cables, terminals, and external surfaces with a mild baking soda and water solution. Rinse thoroughly with clear water.

**NOTE:** Do not allow the baking soda solution to enter the cells as this will destroy the electrolyte.

### Battery Test

To test the battery, you will need a DC voltmeter. Perform the following steps. See Figure 8-2:

1. Connect the voltmeter across the battery terminals.
2. Crank the engine. If the battery drops below 9 volts while cranking, the battery is too small, discharged, or faulty.

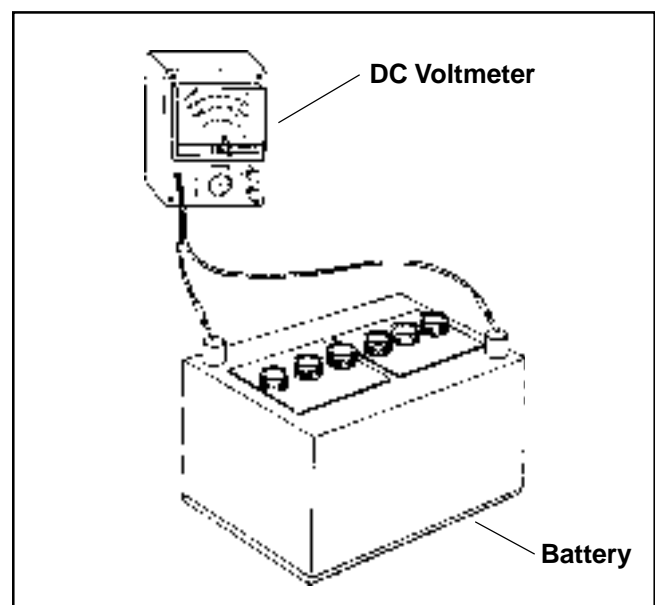


Figure 8-2. Battery Voltage Test.

## Section 8 Electrical System and Components

### Electronic CD Ignition Systems

#### Operation of CD Ignition Systems

Capacitive Discharge with Fixed Timing

This system consists of the following components. See Figure 8-3.

- A magnet assembly which is permanently affixed to the flywheel.

- Two electronic capacitive discharge ignition modules which mount on the engine crankcase.
- A kill switch (or key switch) which grounds the modules to stop the engine.
- Two spark plugs.

The timing of the spark is controlled directly by the location of the flywheel magnet group as referenced to engine top dead center.

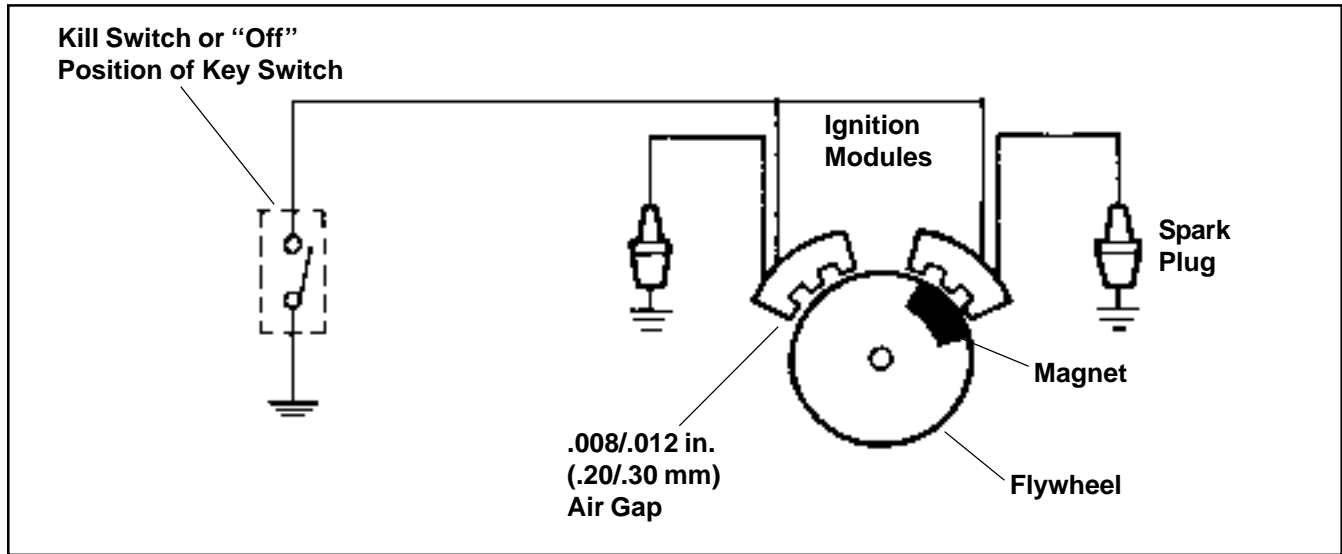


Figure 8-3. Capacitive Discharge Ignition System.

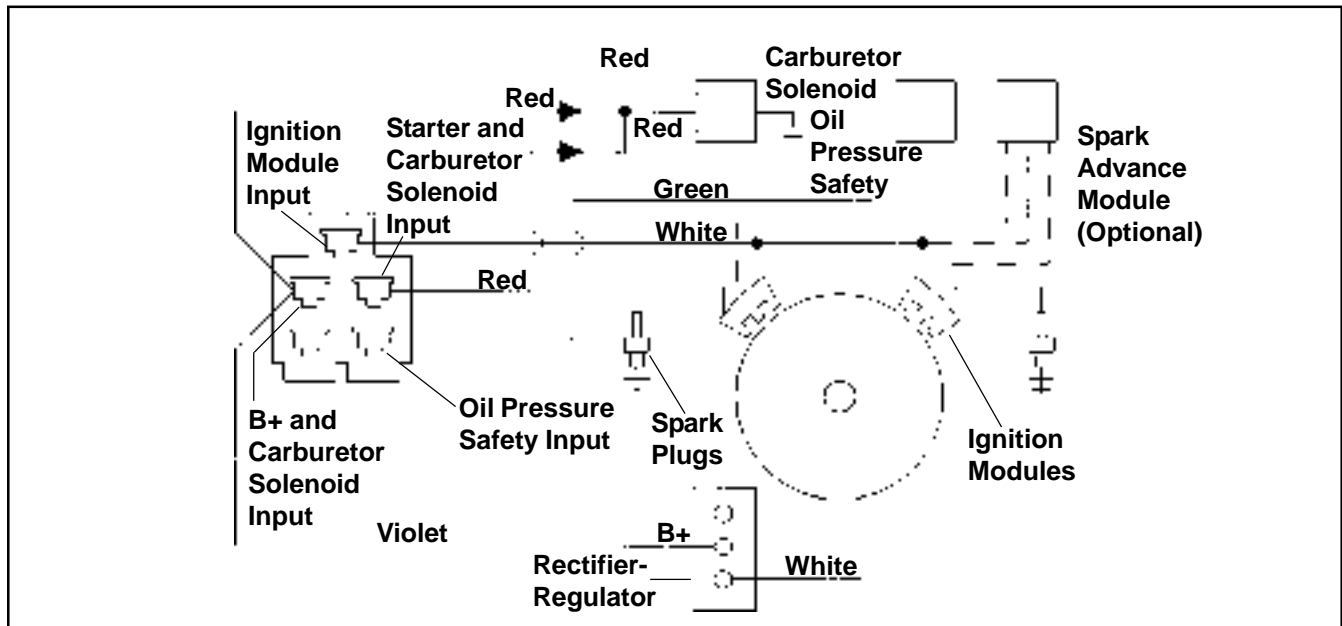
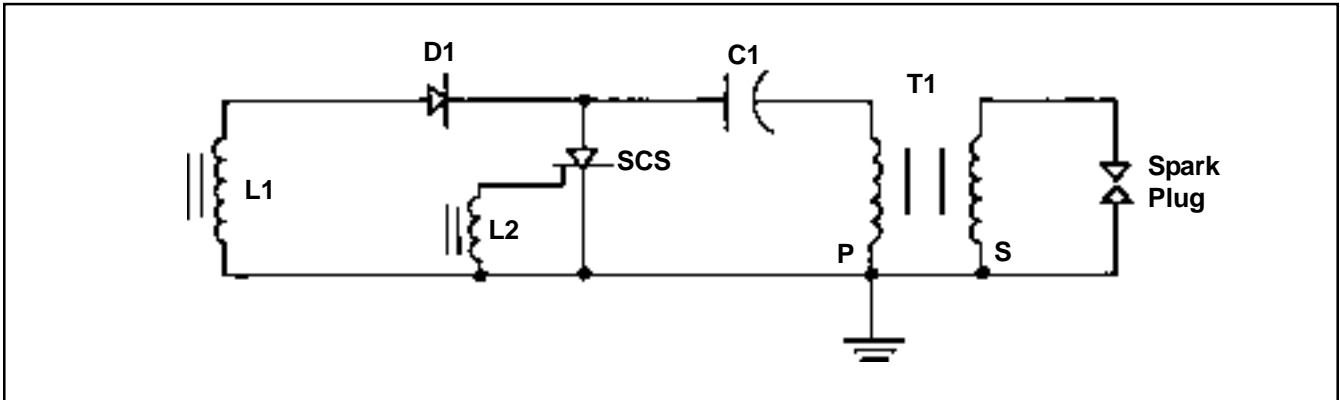


Figure 8-4. Electronic CD Ignition System (For Customer Connected Tractor Applications).



**Figure 8-5. Capacitive Discharge Ignition Module.**

**Operation:** As the flywheel rotates, the magnet grouping passes the input coil (L1). The corresponding magnetic field induces energy into the input coil (L1). The resultant pulse is rectified by D1 and charges capacitor C1. As the magnet assembly completes its pass, it activates the triggering device (L2), which causes the semiconductor switch (SCS) to turn on. With the device switch “ON,” the charging capacitor (C1) is directly connected across the primary (P) of the output transformer (T1). As the capacitor discharges, the current initiates a fast rising flux field in the transformer core. A high voltage pulse is generated from this action into the secondary winding of the transformer. This pulse is delivered to the spark plug gap. Ionization of the gap occurs, resulting in an arc at the plug electrodes. This spark ignites the fuel-air mixture in the combustion chamber.

### Troubleshooting CD Ignition Systems

The CD ignition systems are designed to be trouble free for the life of the engine. Other than periodically checking/replacing the spark plugs, no maintenance or timing adjustments are necessary or possible. Mechanical systems do occasionally fail or break down, however, so the following troubleshooting information is provided to help you get to the root of a reported problem.



**CAUTION: High Energy Electric Spark!**

*The CD ignition systems produce a high energy electric spark, but the spark must be discharged, or damage to the system can result. Do not crank or run an engine with a spark plug lead disconnected. Always provide a path for the spark to discharge to ground.*

Reported ignition problems are most often due to poor connections. Before beginning the test procedure, check all external wiring. Be certain all ignition-related wires are connected, including the spark plug leads. Be certain all terminal connections fit snugly. Make sure the ignition switch is in the run position.

**NOTE:** The CD ignition systems are sensitive to excessive load on the kill lead. If a customer complains of hard starting, low power, or misfire under load, it may be due to excessive draw on the kill circuit. Perform the preliminary test which follows.

### Preliminary Test

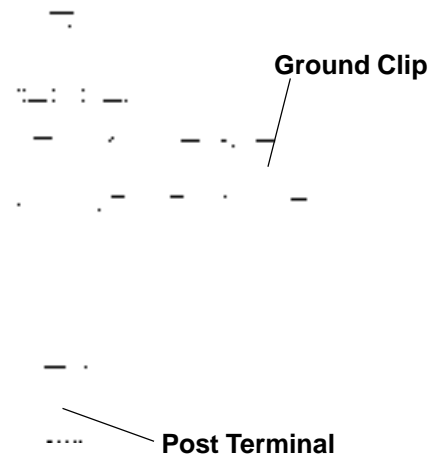
To be certain the reported problem is in the engine ignition system, it should be isolated from the unit.

1. Locate the plug connectors where the wiring harnesses from the engine and unit are joined. Separate the connectors and remove the white “kill” lead from the engine connector. Rejoin the connectors and position or insulate the kill lead terminal so it cannot touch ground. Try to start\* the engine to verify whether the reported problem is still present.
  - a. If the problem is gone, the electrical system on the unit is suspect. Check the key switch, wires, connections, safety interlocks, etc.
  - b. If the problem persists, follow the test procedure on the next page. Leave the kill lead isolated until all testing is completed.

\*NOTE: If the engine starts or runs during any of the testing, you may need to ground the kill lead to shut it down. Because you have interrupted the kill circuit, it may not stop with the switch.

## Section 8 Electrical System and Components

### Test Procedure for Standard CD Ignition

Test	Conclusion
<p>1. Test for spark on both cylinders with Kohler ignition tester, Part No. 24 455 02-S. Disconnect one spark plug lead and connect it to the post terminal of the tester. Connect the clip to a good ground, <b>not</b> to the spark plug. Crank the engine and observe the tester spark gap. Repeat the procedure on the other cylinder. Remember to reconnect the first spark plug lead.</p>  <p>The diagram shows a schematic of the Kohler ignition tester. It features a central coil with two spark plug leads extending from it. A 'Ground Clip' is shown connected to a ground point on the right side of the tester. A 'Post Terminal' is shown connected to the spark plug lead on the left side of the tester.</p>	<p>1. If one side is not firing, check all wiring, connections, and terminations on that side. If wiring is okay, replace ignition module and retest for spark.</p> <p>If the tester shows spark, but the engine misses or won't run on that cylinder, try a new spark plug.</p> <p>If neither side is firing, recheck position of ignition switch and check for shorted kill lead.</p>

### Battery Charging System

#### General

Most engines are equipped with a 15 amp regulated battery charging system. Some have a 25 amp regulated battery charging system. See Figure 8-6 for the 15/25 amp system diagram. Some have a 3 amp unregulated system with optional 70 watt lighting circuit. See Figure 8-7 for 3 amp system diagram.

**NOTE:** Observe the following guidelines to avoid damage to the electrical system and components:

- Make sure the battery polarity is correct. A negative (-) ground system is used.
- Disconnect the plug from the rectifier-regulator and the battery cables before doing electric welding on the equipment powered by the engine.
- Prevent the stator (AC) leads from touching or shorting while the engine is running. This could damage the stator.

Wiring Color Codes	
B	Black
L	Blue
R	Red
Y	Yellow
W	White
P	Purple
O	Orange
L/R	Blue/Red

# Section 8 Electrical System and Components

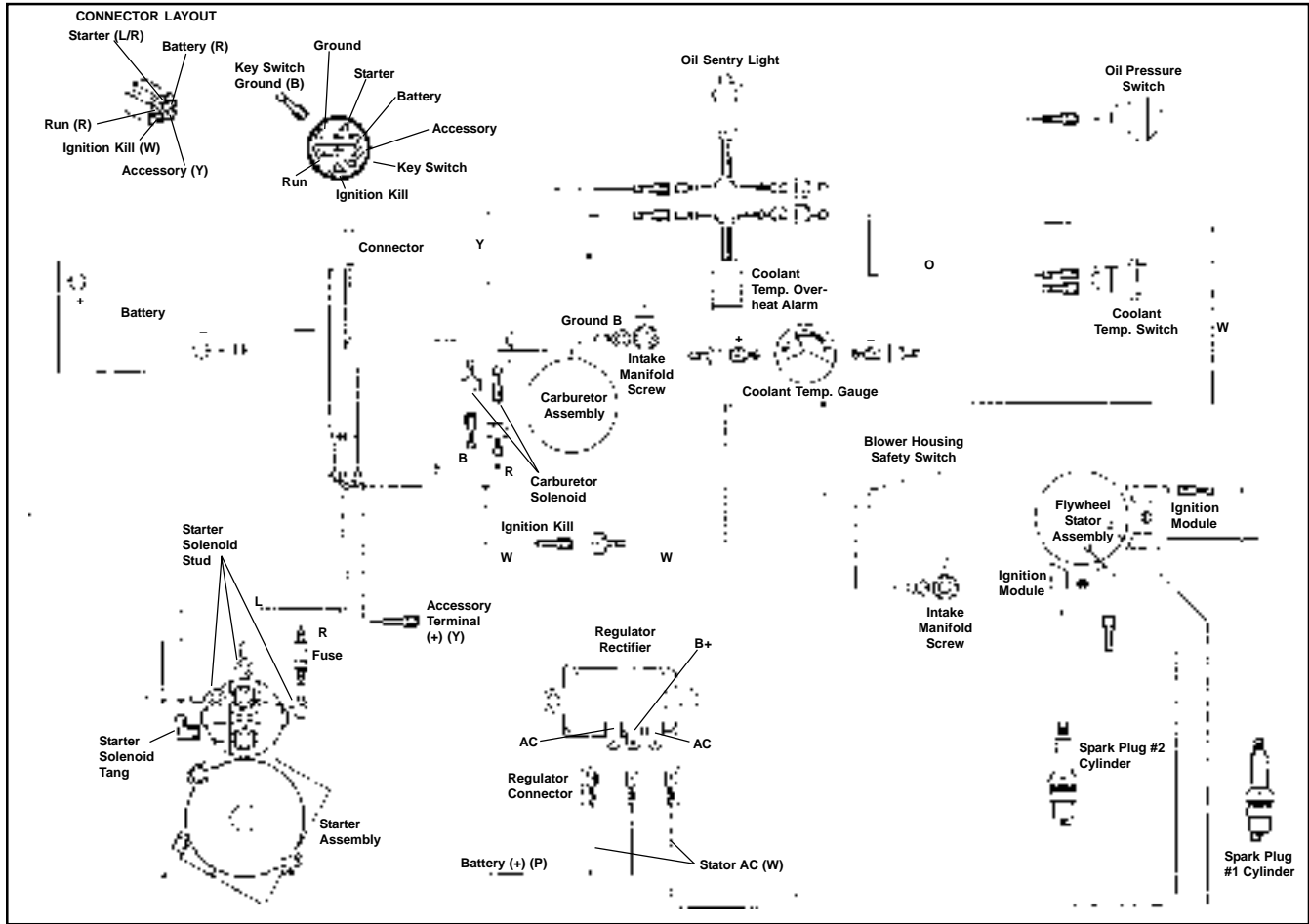


Figure 8-6. Wiring Diagram - 15/20/25 amp Regulated Battery Charging System.

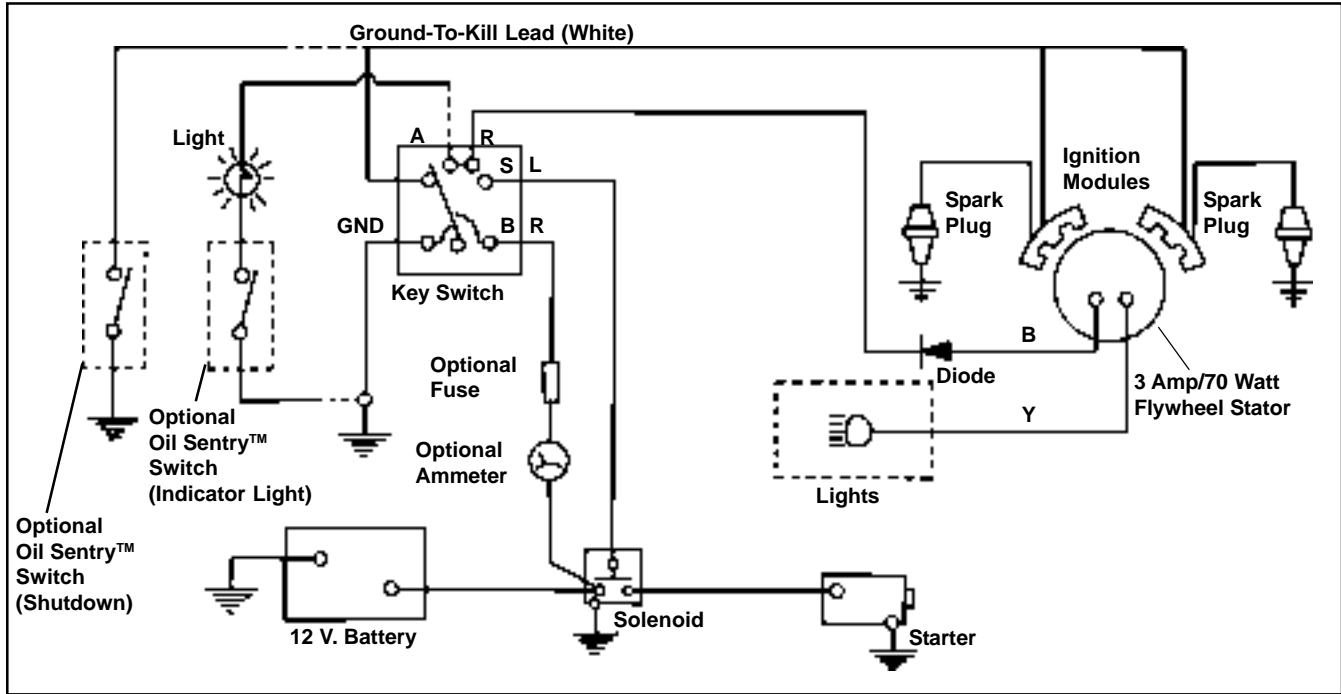


Figure 8-7 Wiring Diagram - 3 amp Unregulated Battery Charging System/70 Watt Lighting.



## Section 8 Electrical System and Components

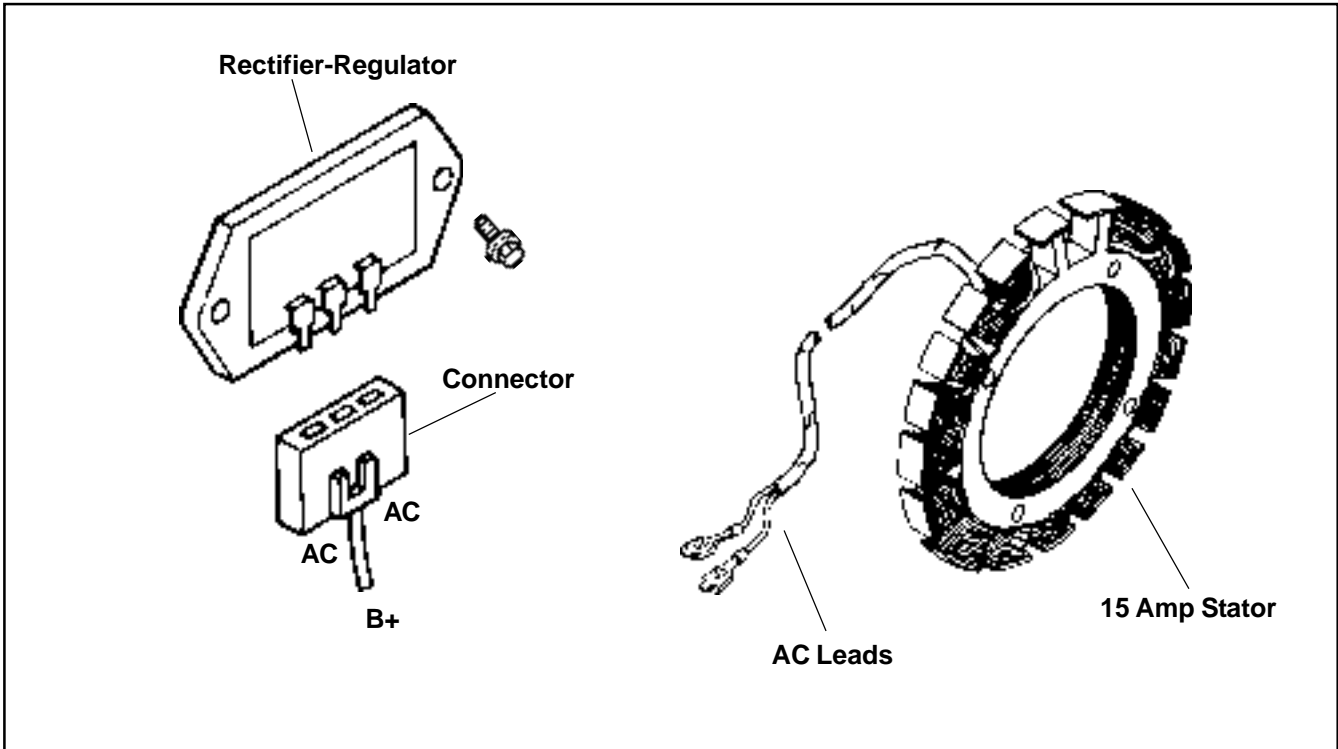


Figure 8-8. 15/20/25 amp Stator and Rectifier-Regulator.

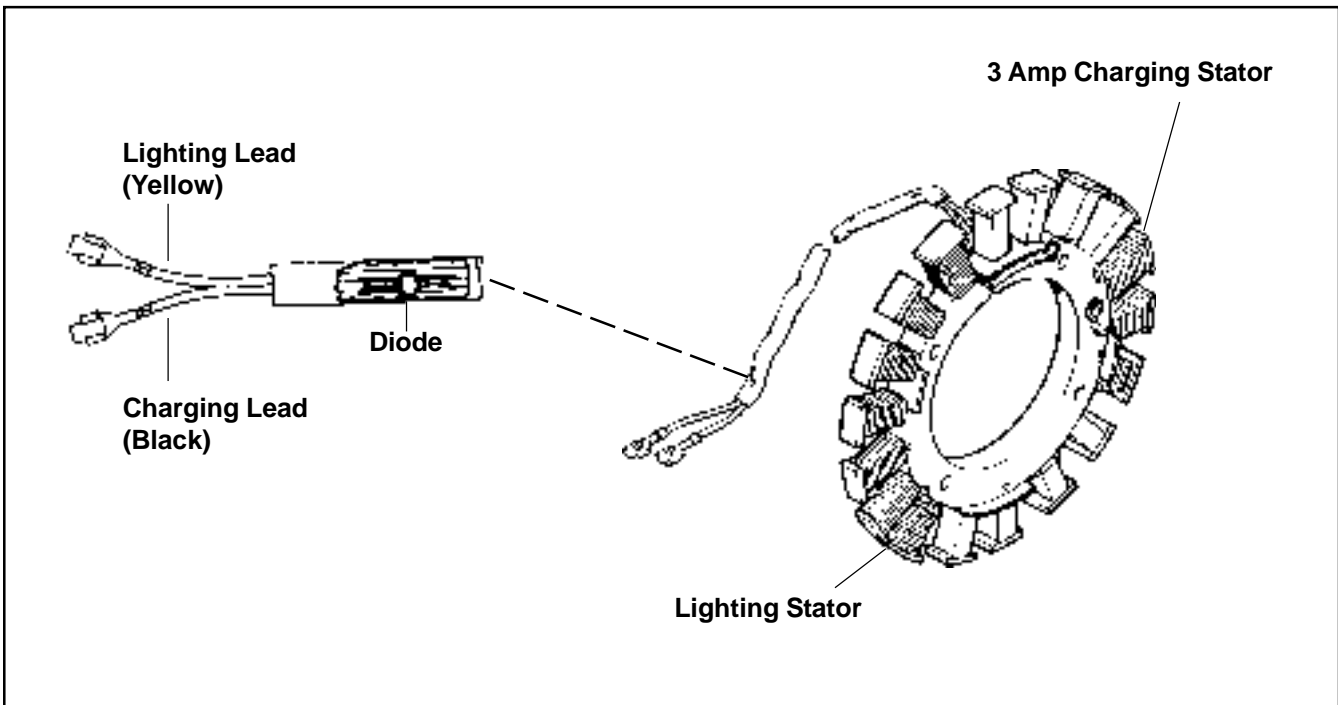


Figure 8-9. 3 amp/70 Watt Stator.

**Stator**

The stator is mounted on the crankcase behind the flywheel. Should the stator have to be replaced, follow the procedures in Section 9 - "Disassembly."

**Rectifier-Regulator**

The rectifier-regulator is mounted inside the lower blower housing. To replace it; remove the upper blower housing, disconnect the connector plug, remove the single mounting screw with the ground lead and lift out the rectifier-regulator.

NOTE: When installing the rectifier-regulator, make sure the cooling fins are "up", and the harness wires remain in the channel of the lower blower housing, with adequate clearance from the flywheel.



Figure 8-10. Rectifier-Regulator.

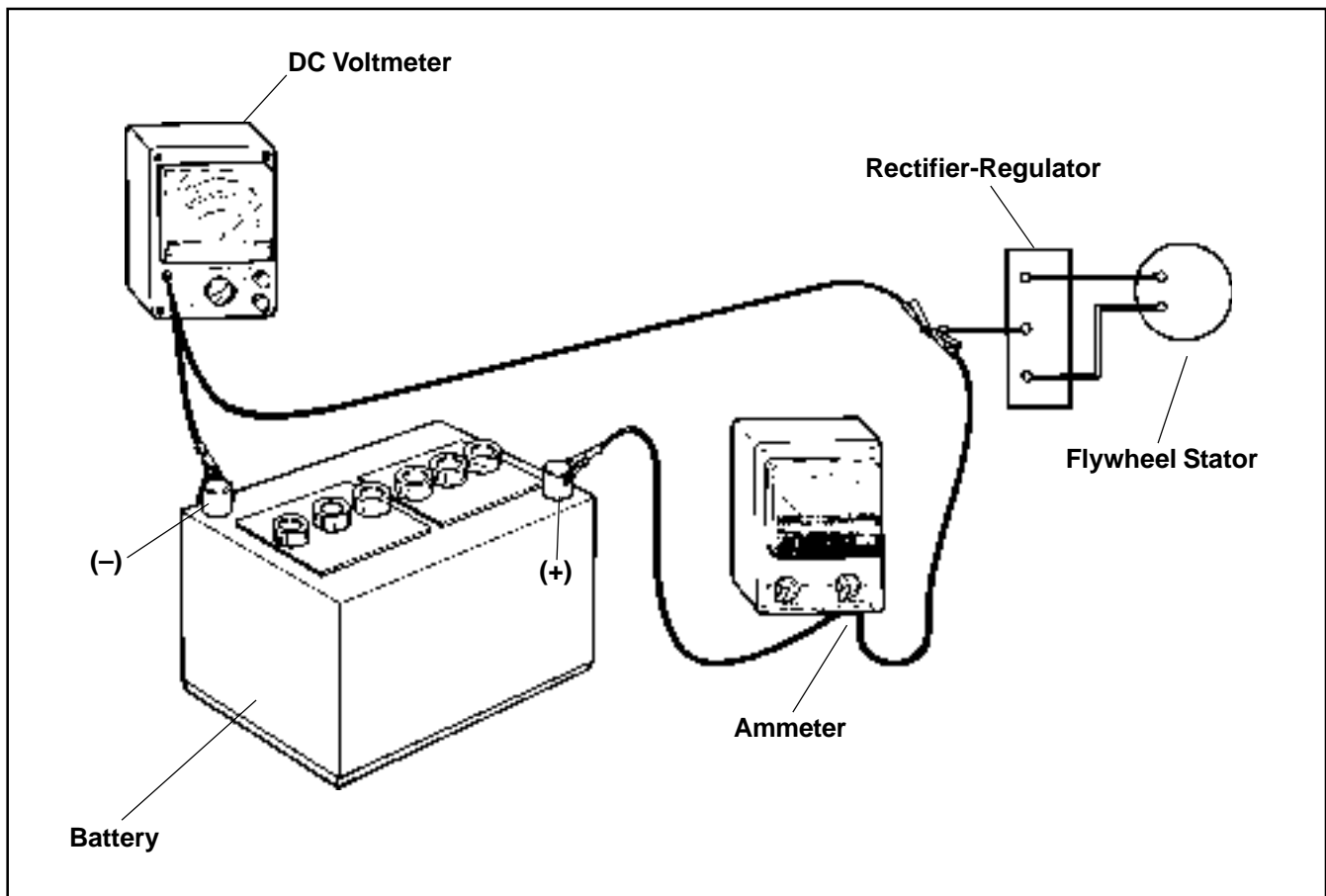


Figure 8-11. Connections for Testing Charging System.

## Section 8

# Electrical System and Components

### Troubleshooting Guide

#### 15/20/25 amp Battery Charging Systems

If it is difficult to keep the battery charged, or the battery overcharges, the problem is usually with the charging system or the battery.

NOTE: **Always zero ohmmeter on each scale before testing** to ensure accurate readings. Voltage tests should be made with the engine running at 3600 RPM - no load. The battery must be fully charged.

Problem	Test	Conclusion
<b>No Charge to Battery</b>	1. Trace B+ lead from rectifier-regulator to key switch, or other accessible connection. Disconnect it from switch or connection. Connect an ammeter from loose end of B+ lead to positive terminal of battery. Connect DC voltmeter from loose end of B+ lead to negative terminal of battery. See Figure 8-11. With engine running at 3600 RPM, read voltage on voltmeter.  If voltage is 13.8 volts or more, place a minimum load of 5 amps* on battery to reduce voltage. Observe ammeter.  *NOTE: Turn on lights (if 60 watts or more) or place a 2.5 ohm, 100 watt resistor across battery terminals.	1. If voltage is 13.8-14.7 and charge rate increases when load is applied, the charging system is OK and battery was fully charged.  If voltage is less than 13.8, or charge rate does not increase when load is applied, test stator (Tests 2 and 3).
	2. Remove connector from rectifier-regulator. With engine running at 3600 RPM, measure AC voltage across stator leads using an AC voltmeter.	2. If voltage is <b>28 volts or more</b> , stator is OK. Rectifier-regulator is faulty. Replace the rectifier-regulator.  If voltage is <b>less than 28 volts</b> , stator is probably faulty and should be replaced. Test stator further using an ohmmeter (Test 3).
	3a. With engine stopped, measure the resistance across stator leads using an ohmmeter.	3a. If resistance is <b>0.064/0.2 ohms</b> , the stator is OK.  If the resistance is <b>infinity ohms</b> , stator is open. Replace stator.
	3b. With the engine stopped, measure the resistance from each stator lead to ground using an ohmmeter.	3b. If the resistance is <b>infinity ohms</b> (no continuity), the stator is OK (not shorted to ground).  If resistance (or continuity) is <b>measured</b> , the stator leads are shorted to ground. Replace stator.
<b>Battery Continuously Charges at High Rate</b>	1. Perform same test as step 1 above.	1. If the voltage is <b>14.7 volts or less</b> the charging system is OK. The battery is unable to hold a charge. Service battery or replace as necessary.  If voltage is <b>more than 14.7 volts</b> , the rectifier-regulator is faulty. Replace rectifier-regulator.

**Troubleshooting Guide**

**3 amp Battery Charging System with 70 Watt Lighting Stator**

NOTE: Zero ohmmeters on each scale to ensure accurate readings. Voltage tests should be made with engine running at 3000 RPM - no load. Battery must be fully charged.

Problem	Test	Conclusion
<b>No Charge to Battery</b>	1. With engine running at 3000 RPM, measure voltage across battery terminals using a DC voltmeter.	1. If voltage is more than 12.5 volts, charging system is OK.  If voltage is 12.5 volts or less, the stator or diode is probably faulty. Test the stator and diode (Tests 2, 3 and 4).
	2. Disconnect the charging lead from battery.  With engine running at 3000 RPM, measure voltage from charging lead to ground using a DC voltmeter.	2. If voltage is <b>28 volts or more</b> , stator winding is OK.  If voltage is <b>less than 28 volts</b> , test stator using an ohmmeter (Tests 3 and 4).
	3. With charging lead disconnected from battery and engine stopped, measure resistance from charging lead to ground using an ohmmeter. Note reading.  Reverse the leads and measure resistance again.  In one direction, the resistance should be infinity ohms (open circuit). With the leads reversed, some resistance should be measured (about midscale on Rx1 range).	3. If resistance is low in both directions, the diode is shorted. Replace the diode.  If resistance is high in both directions, the diode or stator winding is open. (Use Test 4.)
	4. Cut the sleeving on the charging lead to expose the diode connections.  Measure the resistance from the stator side of diode to ground using an ohmmeter.	4. If resistance is approximately <b>1.07 ohms</b> , stator winding is OK.  If resistance is <b>0 ohms</b> , stator winding is shorted. Replace stator.  If resistance is <b>infinity ohms</b> , stator winding or lead is open. Replace stator.
<b>No Lights</b>	1. Make sure lights are not burned out.	1. Replace burned out lights.
	2. Disconnect the lighting lead from the wiring harness.  With engine running at 3000 RPM, measure voltage from lighting lead to ground using an AC voltmeter.	2. If voltage is <b>15 volts or more</b> , stator is OK. Check for loose connections or shorts in wiring harness.  If voltage is <b>less than 15 volts</b> , test stator using an ohmmeter (Test 3).
	3. With engine stopped, measure the resistance of stator from lighting lead to ground using an ohmmeter.	3. If resistance is approximately <b>0.4 ohms</b> , stator is OK.  If resistance is <b>0 ohms</b> , stator is shorted. Replace stator.  If resistance is <b>infinity ohms</b> , stator or lighting lead is open. Replace stator.

## Section 8

### Electrical System and Components

---

#### Solenoid Shift Electric Starters

The following subsection covers the solenoid shift style electric starters. Some of the information in the preceding subsection relates also to this style of starter, so it is not repeated here. A Nippondenso or Delco-Remy solenoid shift starter may be used. The Nippondenso starter is covered beginning on Page 8.21. The Delco Remy starter is covered beginning on page 8.13.

NOTE: Do not drop the starter or strike the starter frame. Doing so can damage the starter.

#### Starter Removal and Installation

Refer to the "Disassembly" and "Reassembly" Sections for starter removal and installation procedures.

#### Starting Motor Precautions

NOTE: Do not crank the engine continuously for more than 10 seconds at a time. If the engine does not start, allow a 60 second cool-down period between starting attempts. Failure to follow these guidelines can burn out the starter motor.

NOTE: If the starter does not crank the engine, shut off the starter immediately. Do not make further attempts to start the engine until the condition is corrected.

#### Troubleshooting Guide – Starting Difficulties

Problem	Possible Fault	Correction
<b>Starter Does Not Energize</b>	<b>Battery</b>	1. Check the specific gravity of battery. If low, recharge or replace battery as necessary.
	<b>Wiring</b>	1. Clean corroded connections and tighten loose connections. 2. Replace wires in poor condition and with frayed or broken insulation.
	<b>Starter Switch or Solenoid</b>	1. Bypass the switch or solenoid with a jumper wire. If starter cranks normally, replace the faulty component.
<b>Starter Energizes But Turns Slowly</b>	<b>Battery</b>	1. Check the specific gravity of battery. If low, recharge or replace battery as necessary. 2. Battery too small, must be at least 400 cold cranking amps.
	<b>Brushes</b>	1. Check for excessively dirty or worn brushes and commutator. Clean using a coarse cloth (not emery cloth). 2. Replace brushes if excessively or unevenly worn.
	<b>Transmission or Engine</b>	1. Make sure the clutch or transmission is disengaged or placed in neutral. This is especially important on equipment with hydrostatic drive. The transmission must be exactly in neutral to prevent resistance which could keep the engine from starting. 2. Check for seized engine components such as the bearings, connecting rod, and piston.

**Delco-Remy Starters**

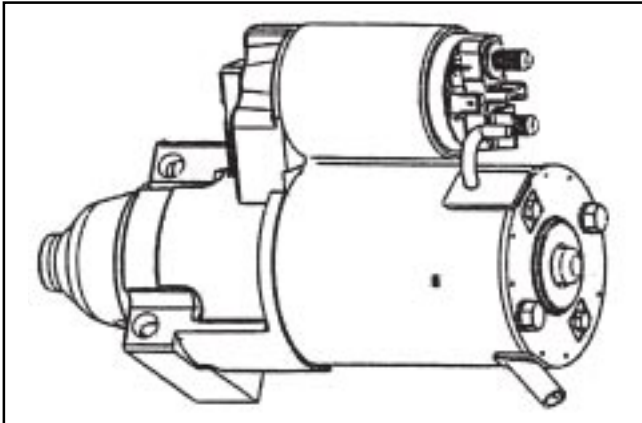


Figure 8-12.

**Starter Disassembly**

1. Remove the hex. nut and disconnect the positive (+) brush lead/bracket from the solenoid terminal.
2. Remove the three screws securing the solenoid to the starter. Remove the solenoid and plunger spring from the drive end cap. See Figure 8-13 and 8-14.



Figure 8-13. Removing Solenoid Screws.

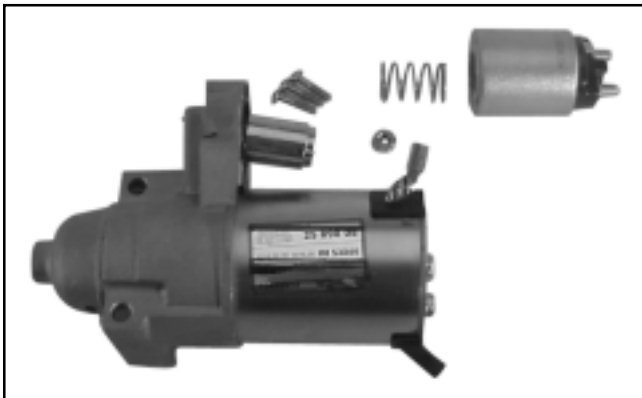


Figure 8-14. Solenoid Removed from Starter.

3. Lift and unhook the plunger assembly from the drive lever. Remove the gasket from the recess in the housing. See Figure 8-15.

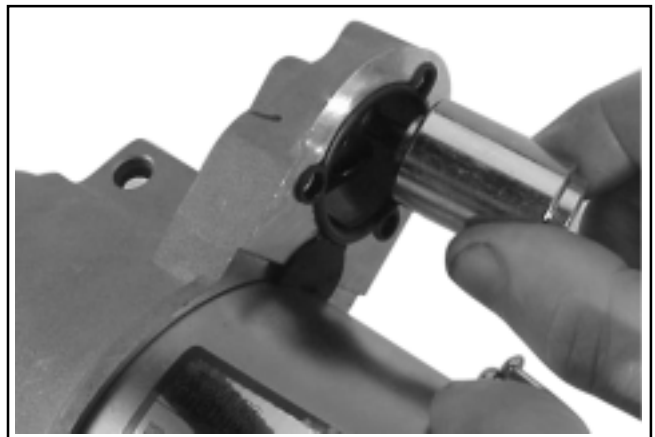


Figure 8-15. Removing Plunger.

4. Remove the two thru (larger) bolts. See Figure 8-16.

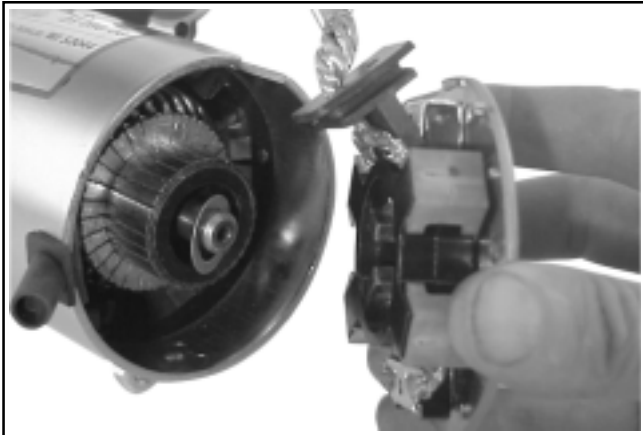


Figure 8-16. Removing Thru Bolts.

## Section 8

### Electrical System and Components

5. Remove the commutator end plate assembly, containing the brush holder, brushes, springs, and locking caps. Remove the thrust washer from inside the commutator end. See Figure 8-17.



**Figure 8-17. Removing Commutator End Plate Assembly.**

6. Remove the frame from the armature and drive end cap. See Figure 8-18.



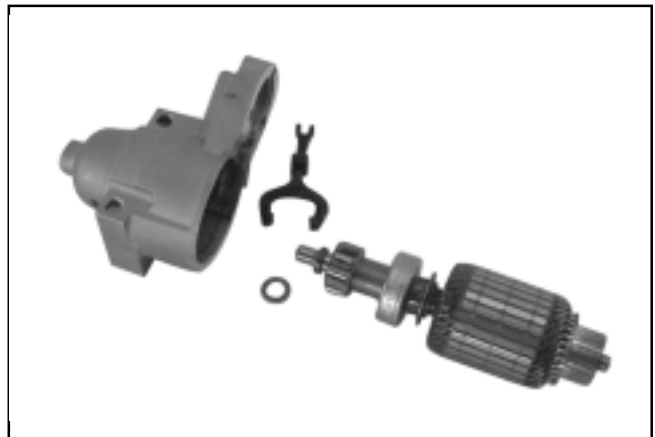
**Figure 8-18. Starter Frame Removed.**

7. Remove the drive lever pivot bushing and backing plate from the end cap. See Figure 8-19.



**Figure 8-19.**

8. Take out the drive lever and pull the armature out from the drive end cap. See Figure 8-20.
9. Remove the thrust washer from the armature shaft. See Figure 8-20.



**Figure 8-20. Armature and Lever Removed.**

10. Push the stop collar down to expose the retaining ring. See Figure 8-21.



**Figure 8-21. Retaining Ring Detail.**

## Section 8 Electrical System and Components

11. Remove the retainer from the armature shaft.  
Save the stop collar.

12. Remove the drive pinion assembly from the armature.

NOTE: Do not reuse the old retainer.

13. Clean the parts as required.

NOTE: **Do not** soak the armature or use solvent when cleaning. Wash and dry/clean using a soft cloth, or compressed air.

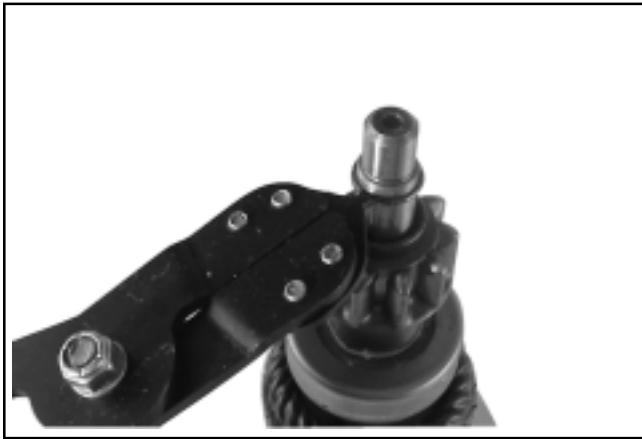


Figure 8-22. Removing Retaining Ring.

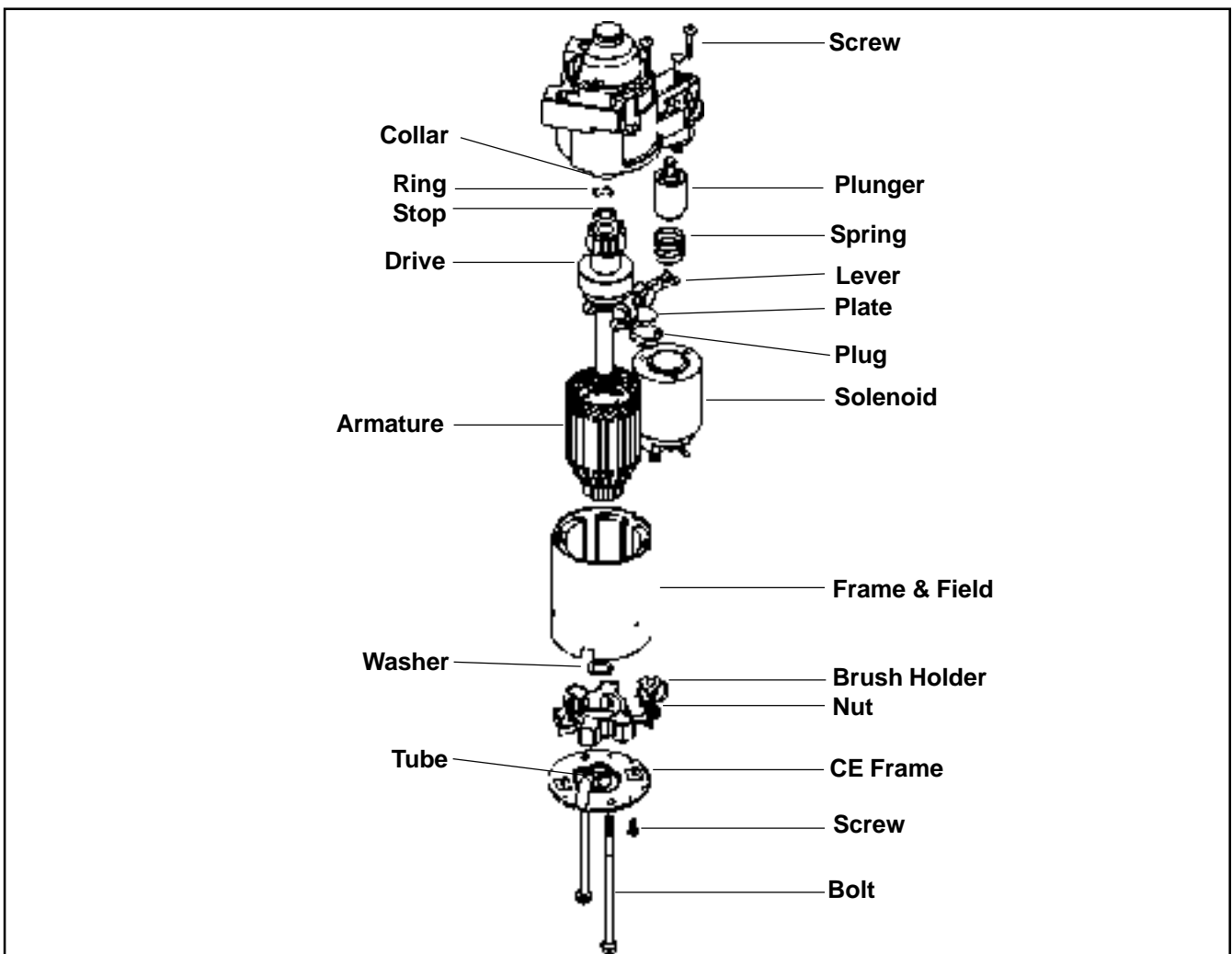


Figure 8-23. Delco-Remy Starter.



## Section 8

# Electrical System and Components

### Inspection

#### Drive Pinion

Check and inspect the following areas:

- The pinion teeth for abnormal wear or damage.
- The O.D. surface between the pinion and the clutch mechanism for nicks, or irregularities which could cause seal damage.
- Check the drive clutch by holding the clutch housing and rotating the pinion. Pinion should rotate in one direction only.

#### Brushes and Springs

Inspect both the springs and brushes for wear, fatigue, or damage. Measure the length of each brush. The minimum length for each brush is **7.6 mm (.300 in.)**. See Figure 8-24. **Replace the brushes if they are worn undersize, or their condition is questionable.**

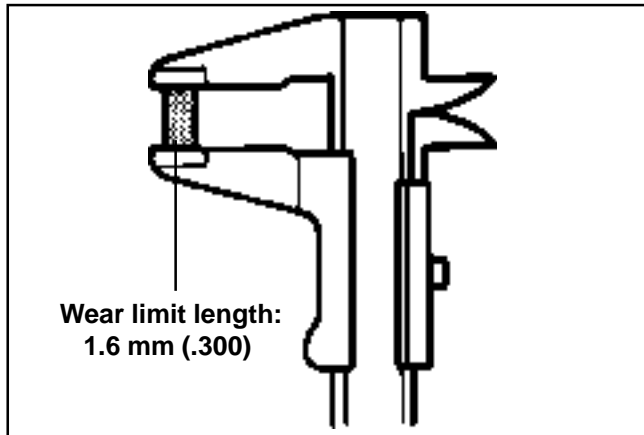


Figure 8-24. Checking Brushes.

#### Armature

- Clean and inspect the commutator (outer surface). The mica insulation of the commutator must be lower than the O.D. surface (undercut) to ensure proper operation of the commutator. See Figure 8-25.

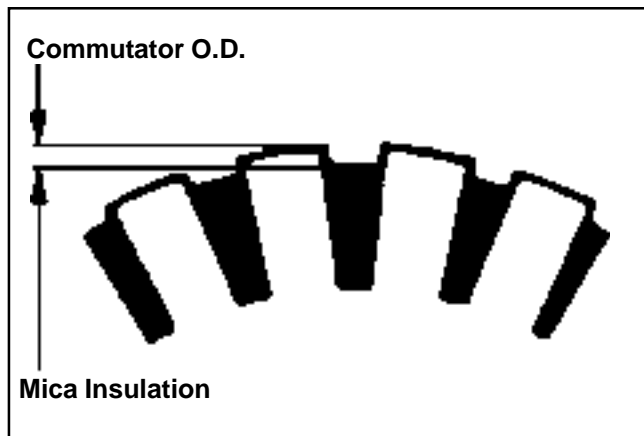


Figure 8-25. Commutator Mica Inspection.

- Use an ohmmeter set to the Rx1 scale. Touch the probes between two different segments of the commutator, and check for continuity. See Figure 8-26. Test all the segments. Continuity **must** exist between all or the armature is bad.

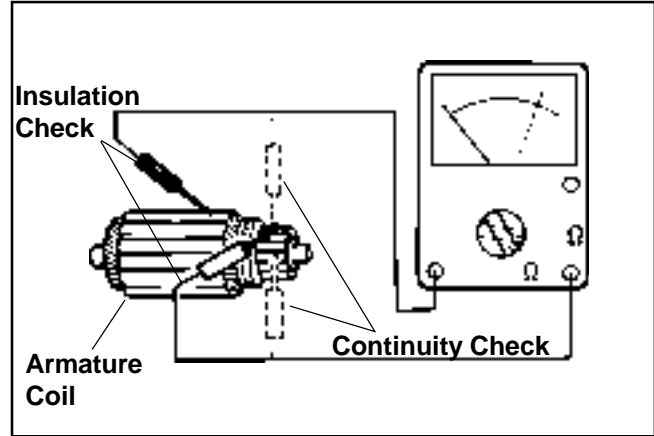


Figure 8-26. Checking Armature.

- Check for continuity between the armature coil segments and the commutator segments. See Figure 8-26. There should be no continuity. If continuity exists between any two, the armature is bad.
- Check the armature windings/insulation for shorting.

#### Shift Fork

Check that the shift fork is complete, and the pivot and contact areas are not excessively worn, cracked or broken.

#### Brush Replacement

The brushes and springs are serviced as a set (4). Use Brush and Spring Kit, Kohler Part No. **25 221 01-S**, if replacement is necessary.

- Perform steps 1-5 in "Starter Disassembly."

2. Remove the two screws securing the brush holder assembly to the end cap (plate). Note the orientation for reassembly later. See Figure 8-27. Discard the old brush holder assembly.



**Figure 8-27. Removing Brush Holder.**

3. Clean the component parts as required.
4. The new brushes and springs come preassembled in a brush holder with a protective sleeve that will also serve as an installation tool. See Figure 8-28.



**Figure 8-28. Service Brush Kit.**

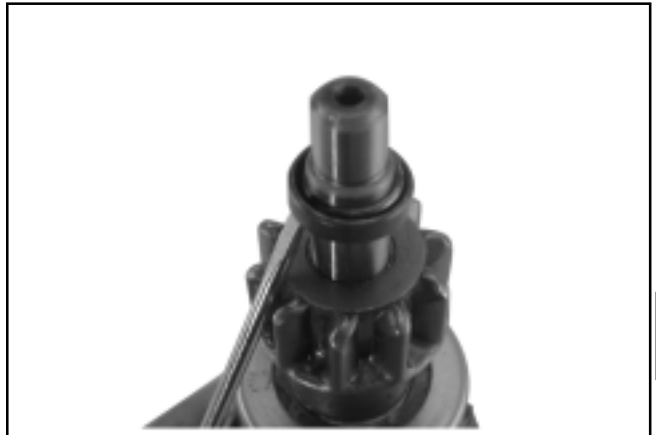
5. Perform Steps 10-13 in the “Starter Reassembly” sequence. (Installation must be done after the armature, drive lever and frame are installed, if the starter has been disassembled.)

### **Starter Service**

Clean the drive lever and armature shaft. Apply Kohler electric starter drive lubricant Part No. **52 357 02-S** to the lever and shaft (Versilube G322L or Mobil Temp SHC 32). Clean and check the other starter parts for wear or damage as required.

### **Starter Reassembly**

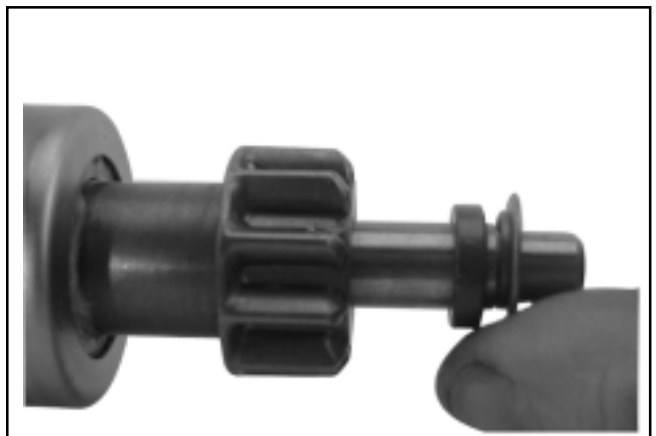
1. Apply new drive lubricant (Kohler Part No. **52 357 02-S**) to the armature shaft splines. Install the drive pinion onto the armature shaft.
2. Install and assemble the stop collar/retainer assembly.
  - a. Install the stop collar down onto the armature shaft with the counter bore (recess) up.
  - b. Install a new retainer in the larger (rear) groove of the armature shaft. Squeeze with a pliers to compress it in the groove.
  - c. Slide the stop collar up and lock it into place, so the recess surrounds the retainer in the groove. If necessary, rotate the pinion outward on the armature splines against the retainer to help seat the collar around the retainer.



**Figure 8-29. Installing Stop Collar and Retainer.**

**NOTE:** Always use a new retainer. Do not reuse old retainers, which have been removed.

3. Install the offset thrust (stop) washer so the smaller “offset” of washer faces the retainer/collar. See Figure 8-30.



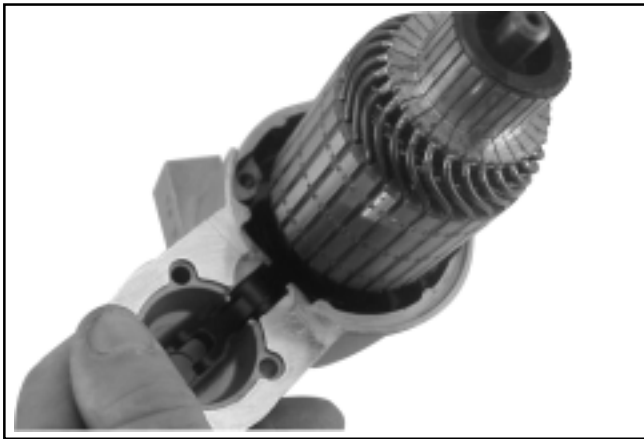
**Figure 8-30. Installing Thrust Washer.**

## Section 8

### Electrical System and Components

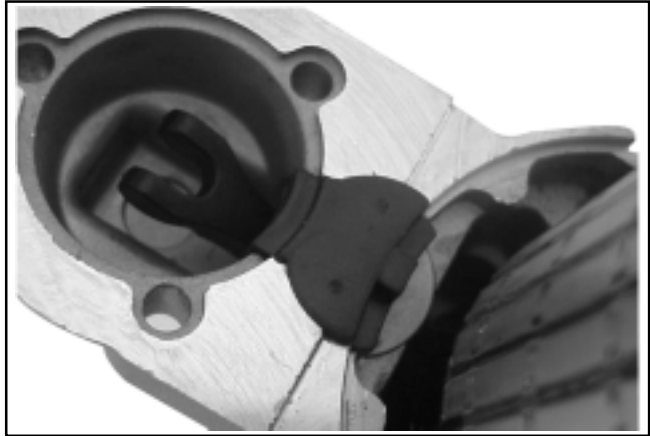
4. Apply a small amount of oil to the bearing in the drive end cap, and install the armature with the drive pinion.
5. Lubricate the fork end and center pivot of the drive lever with drive lubricant (Kohler Part No. 52 357 02-S). Position the fork end into the space between the captured washer and the rear of the pinion.
6. Slide the armature into the drive end cap, and at the same time seat the drive lever into the housing.

**NOTE:** Correctly installed, the center pivot section of the drive lever will be flush or below the machined surface of the housing which receives the backup washer. See Figure 8-31.



**Figure 8-31. Installing Armature and Pivot Lever.**

7. Install the backup washer followed by the rubber grommet, into the matching recess of the drive end cap. The molded recesses in the grommet should be “out”, matching and aligned with those in the end cap. See Figure 8-32.



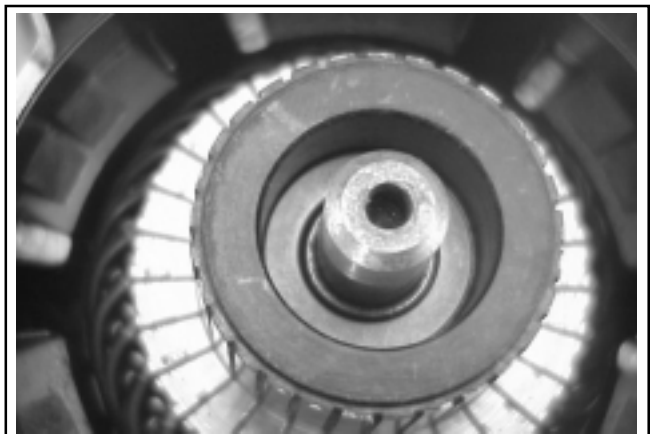
**Figure 8-32. Installing Backup Washer and Grommet.**

8. Install the frame with the small notch forward, onto the armature and drive end cap. Align the notch with the corresponding section in the rubber grommet. Install the drain tube in rear cutout, if it was removed previously. See Figure 8-33.



**Figure 8-33. Installing Frame and Drain Tube.**

9. Install the flat thrust washer onto the commutator end of the armature shaft. See Figure 8-34.



**Figure 8-34. Installing Thrust Washer.**

10. Starter reassembly when **replacing** the Brushes/ Brush Holder Assembly:
- Hold the starter assembly vertically on the end housing, and carefully position the assembled brush holder assembly with the supplied protective tube, against the end of the commutator/armature. The mounting screw holes in the metal clips must be "up/out." Slide the brush holder assembly down into place around the commutator, and install the positive (+) brush lead grommet in the cutout of the frame. See Figure 8-35. Save the protective tube, it may be used for future servicing.



Figure 8-35. Installing Brush Holder Assembly with Supplied Tube.

Starter reassembly when **not replacing** the Brushes/Brush Holder Assembly:

- Carefully unhook the retaining caps from over each of the brush assemblies. Do not lose the springs.



Figure 8-36. Removing Retaining Clips.

- Position each of the brushes back in their slots so they are flush with the I.D. of the brush holder assembly. Insert Brush Installation Tool No. KO3226-1 (w/extension), or use the tube described above from a prior brush installation, through the brush holder assembly, so the holes in the metal mounting clips are "up/out."
- Install the brush springs and snap on the four retainer caps. See Figure 8-37.



Figure 8-37. Brush Installation Tool with Extension.

- Hold the starter assembly vertically on the end housing, and carefully place the tool (w/ extension) and assembled original brush holder assembly onto the end of the armature shaft. Slide the brush holder assembly down into place around the commutator, install the positive (+) brush lead grommet in the cutout of the frame. See Figure 8-38.



Figure 8-38. Installing Brush Holder Assembly using Tool with Extension.

## Section 8

### Electrical System and Components

11. Install the end cap onto armature and frame, aligning the thin raised rib in the end cap with the corresponding slot in the grommet of the positive (+) brush lead.
12. Install the two thru bolts, and the two brush holder mounting screws. Torque the thru bolts to **5.6-9.0 N•m (49-79 in. lb.)**. Torque the brush holder mounting screws to **2.5-3.3 N•m (22-29 in. lb.)**. See Figures 8-39 and 8-40.



Figure 8-39. Torquing Thru Bolts.



Figure 8-40. Torquing Brush Holder Screws.

13. Hook the plunger behind the upper end of the drive lever, and install the spring into the solenoid. Insert the three mounting screws through the holes in the drive end cap. Use these to hold the solenoid gasket in position, then mount the solenoid. Torque the screws to **4.0-6.0 N•m (35-53 in. lb.)**. See Figure 8-41.



Figure 8-41. Installing Solenoid Screws.

14. Connect the positive (+) brush lead/bracket to the solenoid and secure with the hex. nut. Torque the nut to **8-11 N•m (71-97 in. lb.)**, do not overtighten. See Figure 8-42.

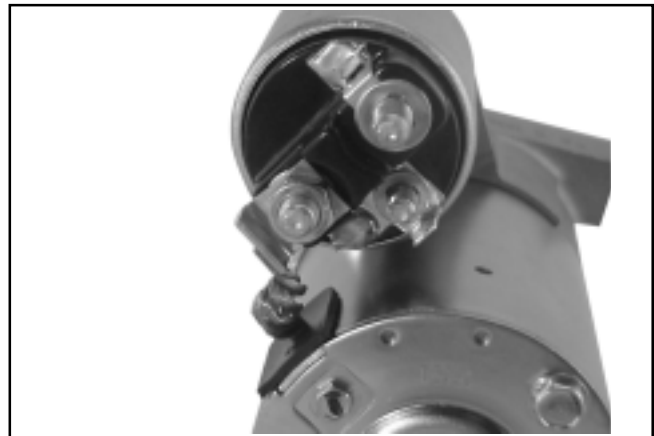
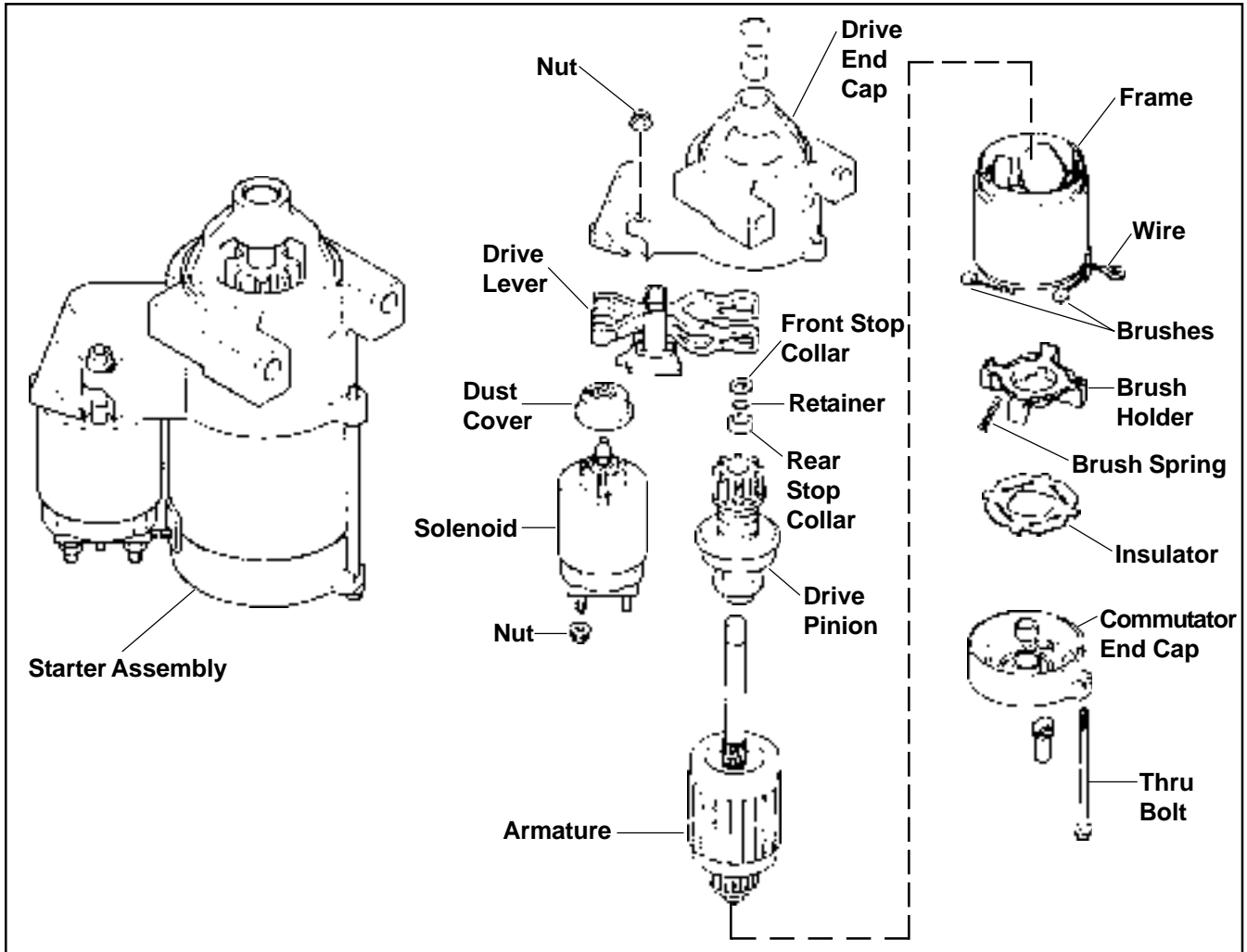


Figure 8-42. Positive (+) Brush Lead Connection.

#### Completed Starter Photo



Figure 8-43. Delco-Remy Starter.



**Figure 8-44. Nippendenso Solenoid Shift Starter.**

**Operation – Solenoid Shift Starter**

When power is applied to the starter the electric solenoid moves the drive pinion out onto the drive shaft and into mesh with the flywheel ring gear. When the pinion reaches the end of the drive shaft it rotates the flywheel and cranks the engine.

When the engine starts and the start switch is released, the solenoid is deactivated, the drive lever moves back, and the drive pinion moves out of mesh with the ring gear, into the retracted position.

**Starter Disassembly**

1. Disconnect the wire from the solenoid.
2. Remove the hex. nuts securing the solenoid, and remove the solenoid from the starter assembly.
3. Remove the two thru bolts.
4. Remove the commutator end cap.
5. Remove the insulator and brush springs from the brush spring holder.
6. Remove the armature from the frame.
7. Remove the drive lever and armature from the drive end cap.

## Section 8

### Electrical System and Components

- The outward travel of the drive pinion is controlled by a snap ring, installed in a groove in the armature shaft, and a two-piece stop collar. The snap ring fits into a recess in the pinion (lower) stop collar, which locks it in the groove (see Figure 8-45). The thrust receiving (upper) stop collar has a projecting flange, which rests on the snap ring, and it serves as a thrust washer to protect the front armature bushing in the drive end cap.

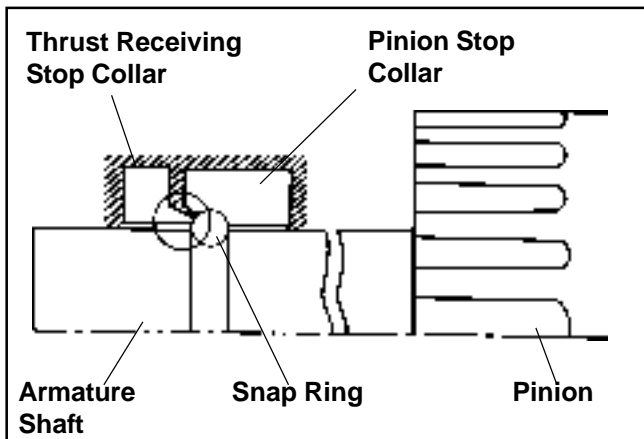


Figure 8-45. Stop Collars and Retainer.

Slide the thrust receiving stop collar off the end of the armature shaft. Place the open end of a 13 mm or 1/2" deep socket over the end of the armature shaft, so the end of the socket is against the top of the pinion stop collar. Tap the other end of the socket with a small hammer of soft head mallet to separate the collar from the snap ring. See Figure 8-46.

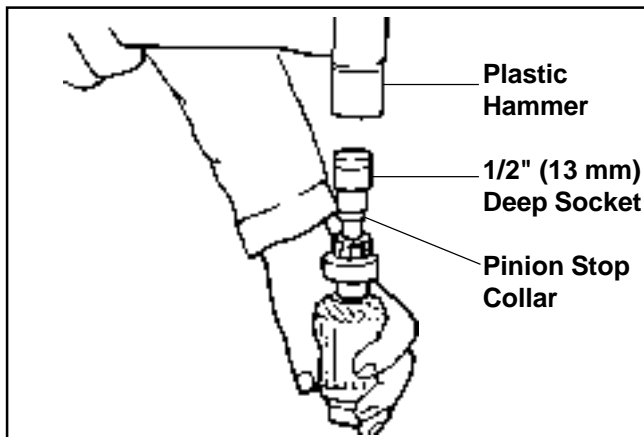


Figure 8-46. Separating the Pinion Stop Collar from the Retainer.

- Remove and discard the snap ring, then slide the pinion stop collar off of the armature shaft.
- Remove the pinion from the splines.

### Brush Replacement

The brushes in the starter are part of the starter frame. Brush kit Part No. 52 221 01-S contains four replacement brushes and springs. If replacement is necessary, all four brushes should be replaced.

- Remove brushes from brush holder, and remove brush holder from frame.
- Cut the brush lead wire at the edge of the post with a pair of side cutters.
- File off burrs on the post.
- The replacement brushes have a solid portion on them which should be crimped on the post.
- Solder the crimped portion to the post.
- Replace the brush holder in the frame and place the brushes in the brush holder. Reinstall the springs.

### Starter Service

Every **500 hours** of operation (or annually, whichever comes first), solenoid shift starters must be disassembled, cleaned and relubricated. Apply Kohler solenoid shift starter lubricant (Part No. 52 357 02-S) to lever and shaft. Failure to do so could result in an accumulation of dirt or debris that might prevent the engine from starting and could cause damage to the starter or flywheel. Service may be necessary more frequently under dusty or dirty conditions.

### Starter Reassembly

- Apply new drive lubricant (Kohler Part No. 52 357 02-S) to the armature shaft splines and drive lever. Install the pinion onto the splines.
- Slide the pinion stop collar onto the armature shaft with the recessed side up. Install a new snap ring in the armature shaft groove. Squeeze it with a pliers, to seat/compress it in the groove.
- Clamp a Vise-Grip® or other locking jaw pliers onto the pinion, between the drive gear and the clutch. Turn the pinion out on the splines until it contacts the pinion stop collar and pushes it up into position around the snap ring. Slide the thrust receiving stop collar onto the armature shaft with the flange toward the snap ring. Apply a coating of drive lubricant to the stop collars.
- Reassemble the remaining components of the starter in reverse order from disassembly.

## Section 9

# Disassembly



### **WARNING: Accidental Starts!**

**Disabling engine. Accidental starting can cause severe injury or death.** Before working on the engine or equipment, disable the engine as follows: 1) Disconnect the spark plug lead(s). 2) Disconnect negative (-) battery cable from battery.

### **General**

Clean all parts thoroughly as the engine is disassembled. Only clean parts can be accurately inspected and gauged for wear or damage. There are many commercially available cleaners that will quickly remove grease, oil and grime from engine parts. When such a cleaner is used, follow the manufacturer's instructions and safety precautions carefully.

Make sure all traces of the cleaner are removed before the engine is reassembled and placed into operation. Even small amounts of these cleaners can quickly break down the lubricating properties of engine oil.

### **Typical Disassembly Sequence**

The following sequence is suggested for complete engine disassembly. The sequence can be varied to accommodate options or special equipment.

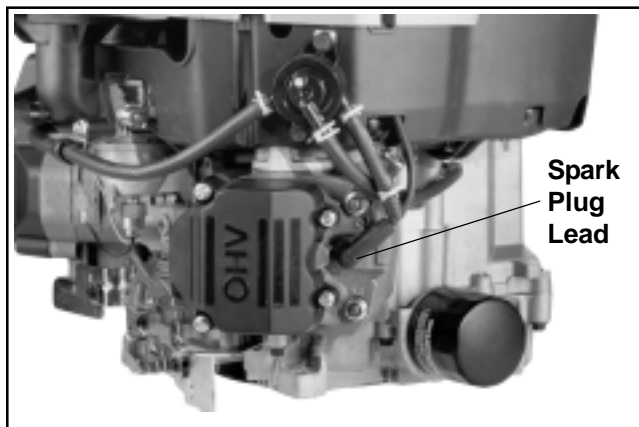
1. Disconnect battery and spark plug leads.
2. Turn fuel shut-off valve to "off" position.
3. Drain oil from crankcase and remove oil filter.
4. Remove upper blower housing assembly.
5. Remove muffler.
6. Drain coolant from cooling system.
7. Remove fuel pump.
8. Remove air cleaner base.
9. Remove carburetor.
10. Remove control bracket assembly and external governor lever.
11. Remove electric starter.
12. Remove flywheel fan and blocking plates.
13. Remove overflow reservoir.
14. Remove ignition modules.
15. Remove flywheel.
16. Remove radiators and cooling system.
17. Remove stator and rectifier-regulator.
18. Remove cam pulley and water pump belt.

19. Remove water pump and transfer tube.
20. Remove by-pass hose and wiring harness.
21. Remove intake manifold, temperature sensor, and thermostat.
22. Remove lower blower housing and oil fill/dipstick tube.
23. Remove Oil Sentry™ (if so equipped).
24. Remove breather cover.
25. Remove spark plugs.
26. Remove valve covers.
27. Remove cylinder heads and hydraulic lifters.
28. Remove oil pan assembly.
29. Remove camshaft.
30. Remove governor cross shaft.
31. Remove connecting rods with pistons and rings.
32. Remove crankshaft.

### **Disconnect Battery and Spark Plug Leads**

1. Disconnect the leads from the spark plugs. See Figure 9-1. Disconnect the battery cables from the battery, starting with the negative (-) cable.

**NOTE:** Pull on boot only, to prevent damage to spark plug lead.



**Figure 9-1. Disconnecting Spark Plug Leads.**



## Section 9 Disassembly

### Shut Off Fuel Supply

### Drain Oil From Crankcase and Remove Oil Filter

1. Remove the dipstick and one of the oil drain plugs. See Figures 9-2 and 9-3.



Figure 9-2. Removing Oil Fill Cap/Dipstick.

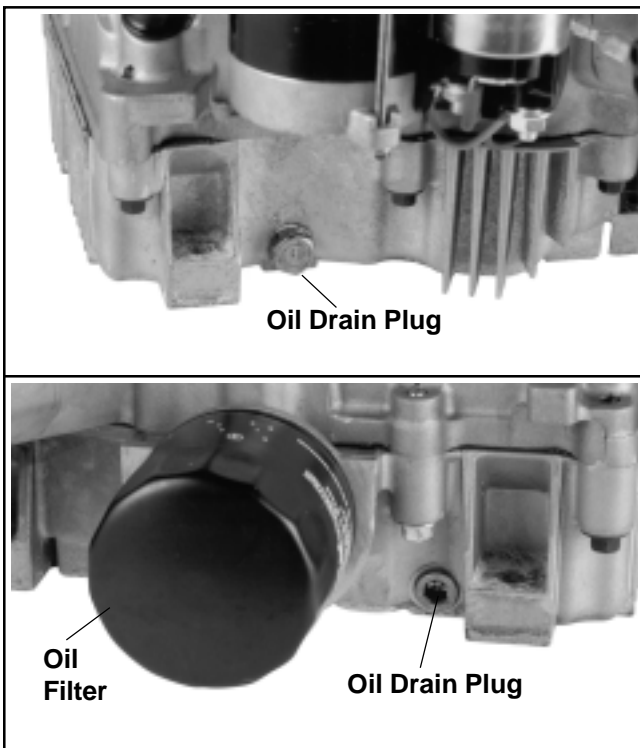


Figure 9-3. Oil Drain Plugs and Oil Filter.

2. Allow ample time for the oil to drain from the crankcase and oil filter.

3. There is likely to be some oil left in the filter. Place a shallow pan under the filter pad and filter to catch the overflow. Remove the oil filter by turning it in a counterclockwise direction with a filter wrench. Discard filter. See Figure 9-4.



Figure 9-4. Removing Oil Filter.

### Remove Upper Blower Housing Assembly

1. Unhook the four retainer straps and lift off the upper housing and screen assembly. The screen assembly may be unsnapped from the underside and separated for servicing if required. See Figures 9-5 and 9-6.

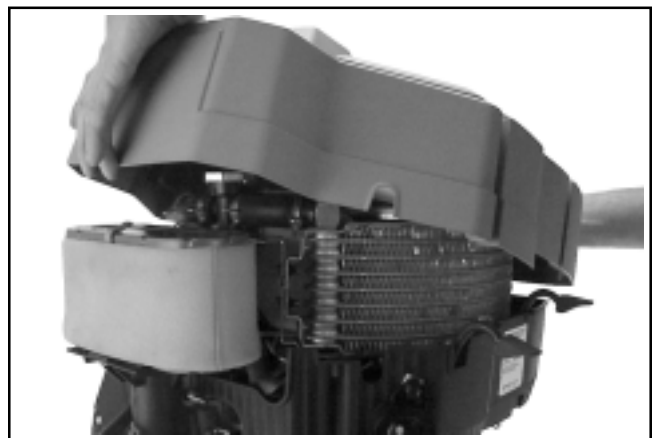


Figure 9-5. Removing Upper Blower Housing.

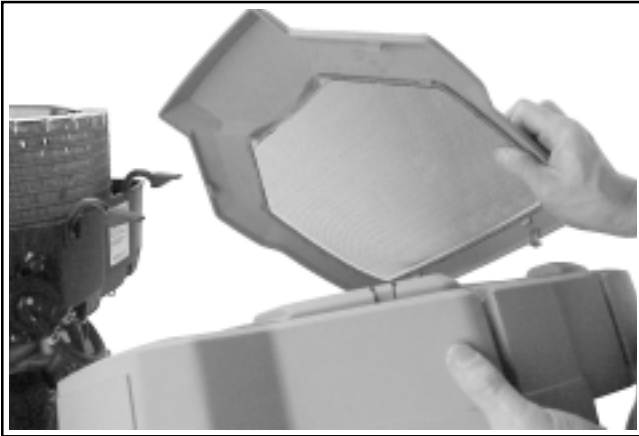


Figure 9-6. Separating Screen from Housing.

### Remove Muffler

1. Remove the muffler or exhaust system and attaching hardware from the engine. See Figure 9-7.

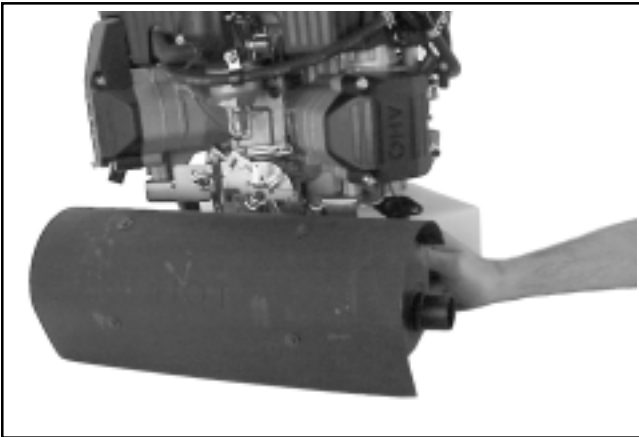


Figure 9-7. Removing Muffler.

### Drain Cooling System

1. Make sure the engine is cool. Slowly remove the radiator cap. See Figure 9-8.



Figure 9-8. Removing Radiator Cap.

2. Carefully remove the coolant drain plugs in the lower side of both cylinder heads. See Figure 9-9. Drain the coolant into a suitable container. Early production units contained steel plugs, remove only when the cylinders are cool. Replace with brass (soft) plugs on reassembly, Kohler Part No. 66 139 01-S.

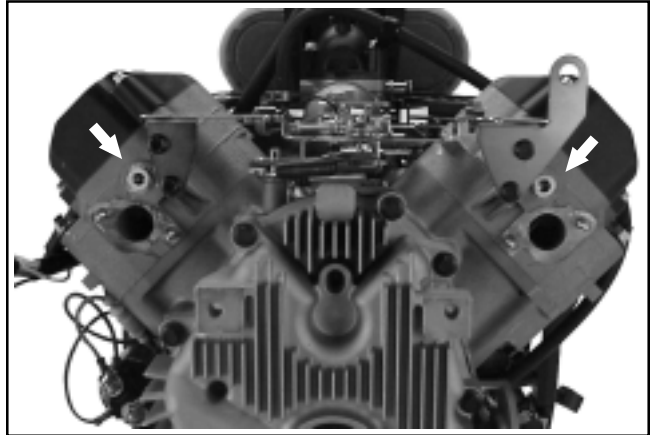


Figure 9-9. Location of Coolant Drain Plugs.

### Remove Fuel Pump

1. Disconnect the pulse (vacuum) line from the crankcase fitting. See Figure 9-10.



Figure 9-10. Disconnecting Pulse Line from Fitting.

## Section 9

### Disassembly

---

2. Disconnect the fuel lines at the inlet of the carburetor, and the in-line fuel filter. See Figure 9-11.

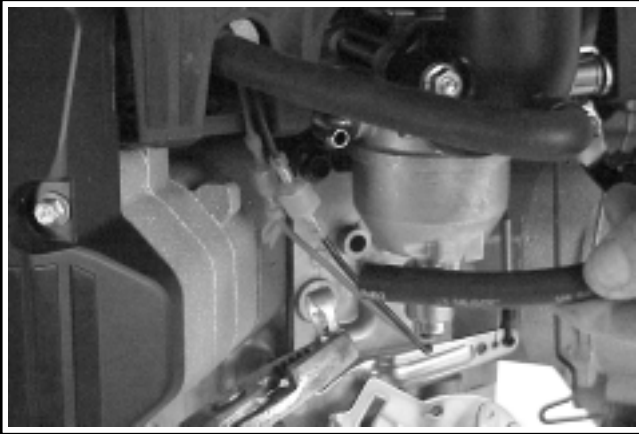


Figure 9-11. Removing Fuel Line at Carburetor.

3. Remove the two hex. flange screws securing the fuel pump to the blower housing and remove the pump and lines as an assembly. Slide the fuel line out of the clip attached to mounting stud. See Figure 9-12.

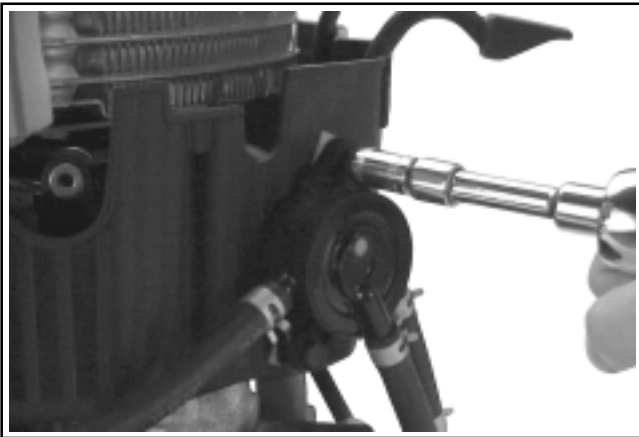


Figure 9-12. Removing Fuel Pump.

### Remove Air Cleaner Base

1. Disconnect the breather hose from the air cleaner base. See Figure 9-13.

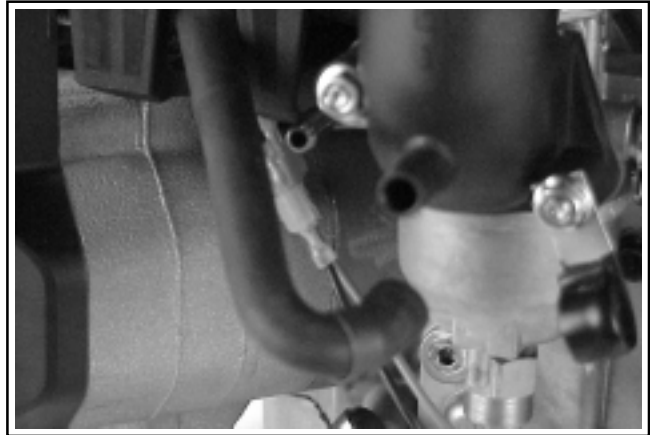


Figure 9-13. Removing Breather Hose from Air Cleaner Base.

2. Remove the two hex. flange nuts securing the air cleaner base assembly to the carburetor studs. See Figure 9-14.

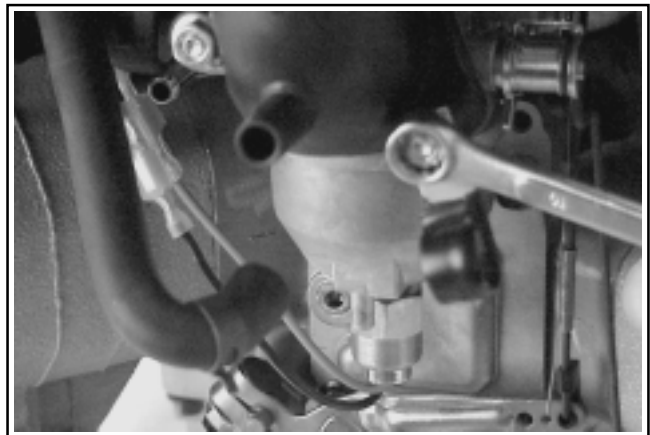


Figure 9-14. Removing Air Cleaner Base.

3. Remove clamp and air cleaner base (with element) from the studs.

### Remove Carburetor

1. Disconnect the fuel solenoid leads (most models) from the wiring harness.
2. Disconnect the dampening spring and throttle linkage from the governor arm. Remove the black bushing, and clip it back onto the linkage, so it does not get lost. See Figure 9-15.

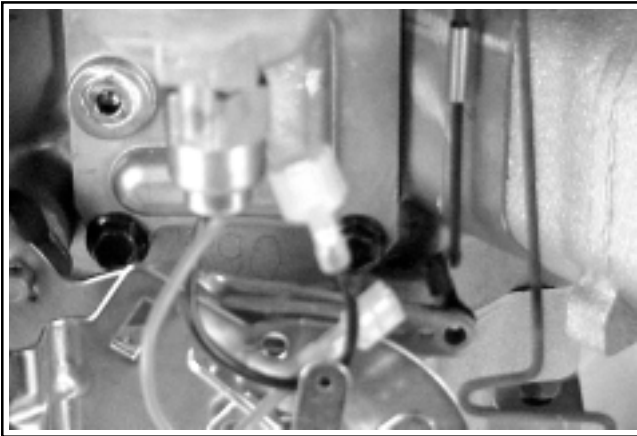


Figure 9-15. Removing Throttle Linkage, Dampening Spring, and Black Bushing.

3. Gently lift up on the lower blower housing, directly above the carburetor, and slide the carburetor outward on the studs. See Figure 9-16.

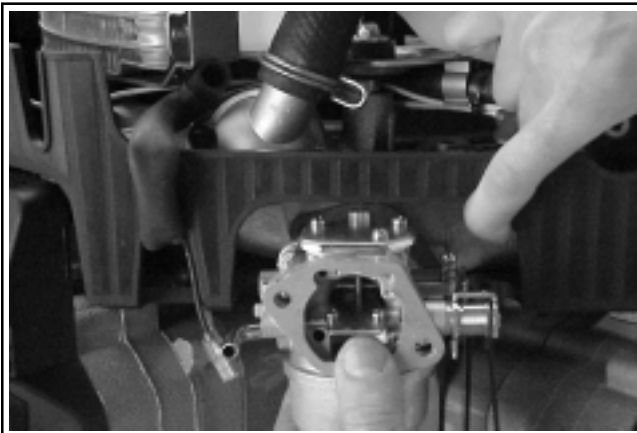


Figure 9-16. Lifting Edge of Lower Housing/ Removing Carburetor.

4. Disconnect the choke linkage from the carburetor, then remove the carburetor and gaskets from the studs.

### Remove Control Bracket Assembly and External Governor Lever

1. Disconnect any remote throttle and/or choke control cables connected to the throttle control bracket.
2. Loosen the hex. flange nut on the clamp screw securing the governor lever to the cross shaft. See Figure 9-17.

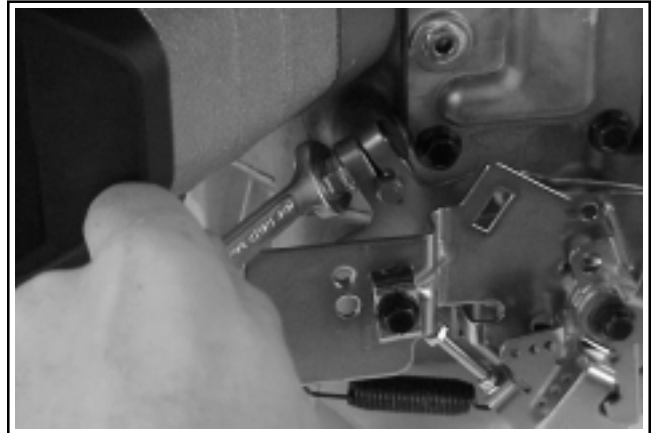


Figure 9-17. Loosening Governor Lever Clamp Nut.

3. Remove the four hex. flange screws securing the throttle control bracket to the cylinder heads. See Figure 9-18.

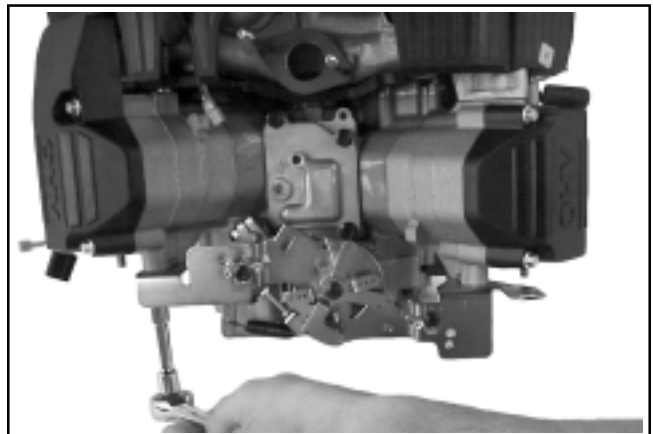


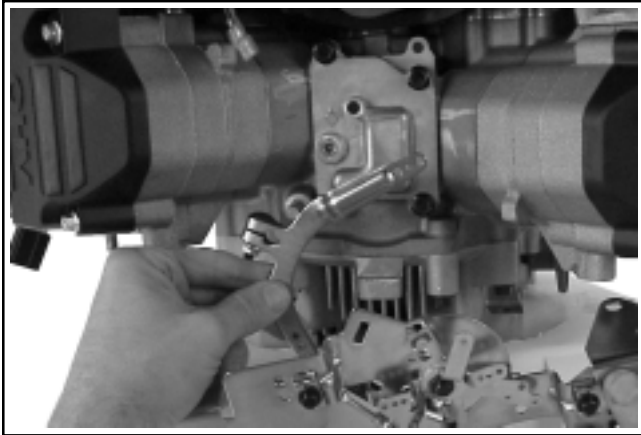
Figure 9-18. Removing the Four Screws from Main Throttle Bracket.

## Section 9

### Disassembly

---

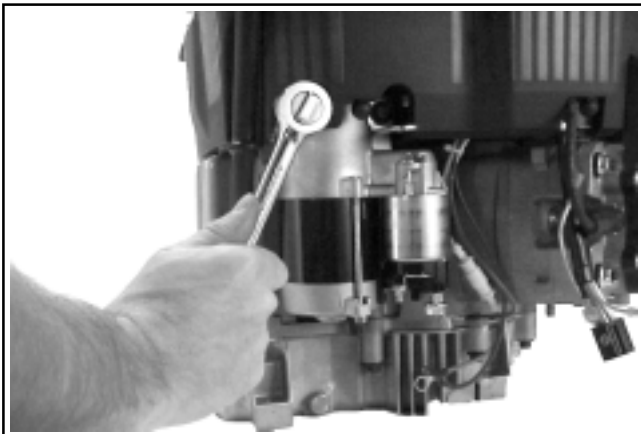
4. Remove the throttle control bracket, governor lever, and governor spring as an assembly. See Figure 9-19.



**Figure 9-19. Removing Main Bracket and Governor Lever.**

#### Remove Electric Starter

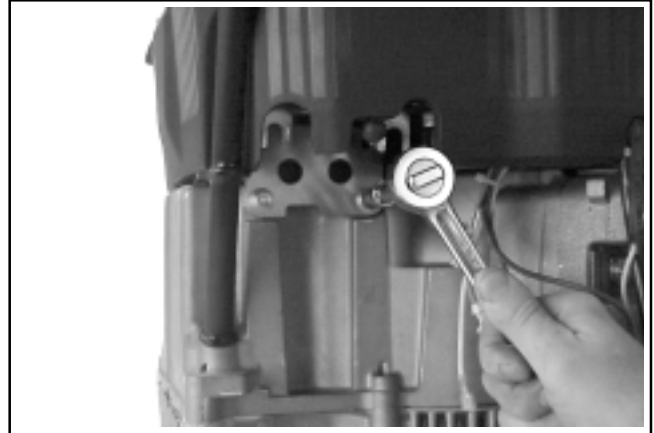
1. Disconnect the leads from the starter.
2. Remove the two starter motor mounting screws. See Figure 9-20.



**Figure 9-20. Removing the Starter Motor Mounting Screws.**

3. Remove the starter assembly from the adapter plate.

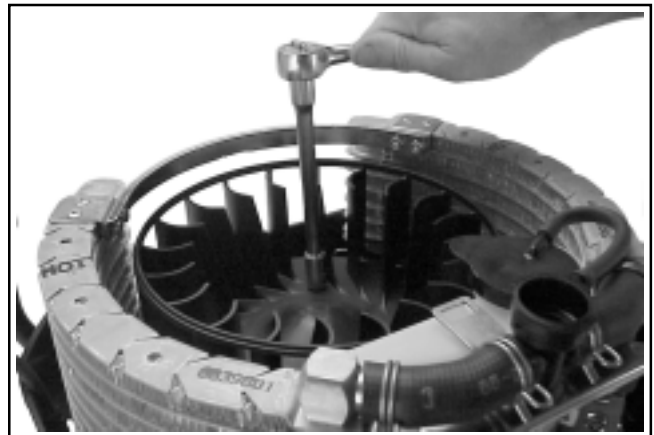
4. Remove the two hex. flange screws and separate the adapter plate from the crankcase. Note the orientation of the notch on the bottom, toward the dipstick. See Figure 9-21.



**Figure 9-21. Removing Adapter Plate Screws.**

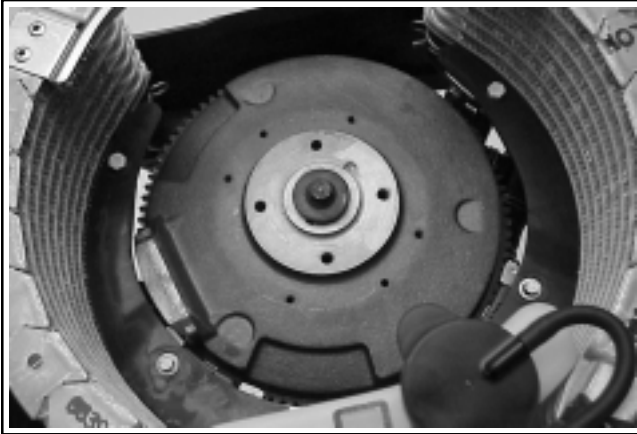
#### Remove Flywheel Fan and Blocking Plates

1. Remove the four shoulder screws securing the fan to the flywheel and remove the fan. See Figure 9-22.



**Figure 9-22. Removing Flywheel Fan.**

2. Remove the four screws securing the R.H. and L.H. blocking plates to the radiator supports and take out the plates. See Figure 9-23.



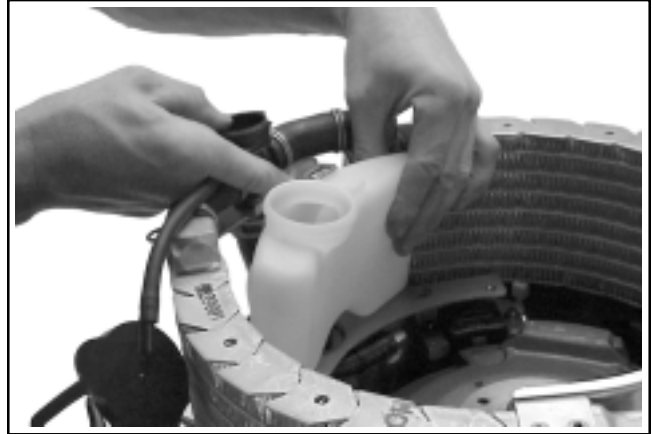
**Figure 9-23. Location of Four Screws Securing Blocking Plates.**

### **Remove Overflow Reservoir**

1. Remove the reservoir cap from the reservoir.
2. Loosen the two screws holding the overflow reservoir retainer bracket to the radiators. See Figure 9-24.
3. Carefully lift the bracket up slightly to unhook the locking tab, and remove the reservoir from under the bracket. See Figure 9-25.



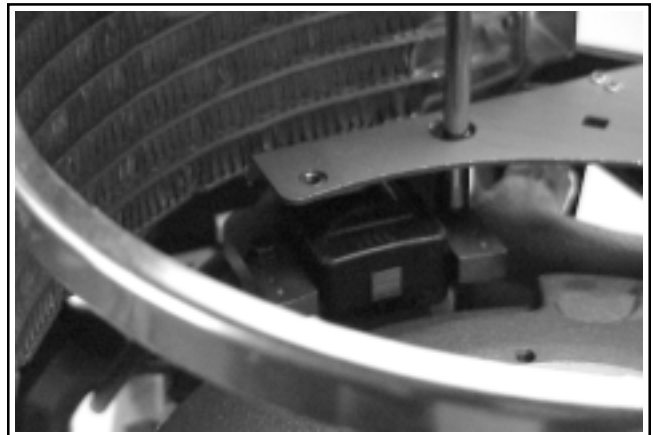
**Figure 9-24. Loosening Reservoir Bracket Screws.**



**Figure 9-25. Removing the Reservoir.**

### **Remove Ignition Modules**

1. Rotate the flywheel to position one of the tapered sections of the flywheel in line with one of the ignition modules.
2. Remove the mounting screws securing the ignition module. Access the inner screw through the hole in the main support bracket. See Figure 9-26.



**Figure 9-26. Removing Inner Ignition Module Mounting Screw.**

## Section 9

### Disassembly

- Slide the ignition module onto the contoured section of the flywheel. Disconnect the lead and remove the module from the engine.

Note: On modules containing 90° terminals, the leads must be removed by pulling to the side. See Figure 9-27.

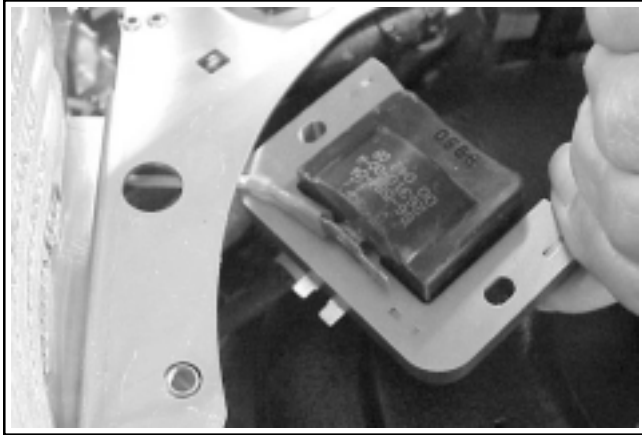


Figure 9-27. Removing Ignition Module.

- Repeat the procedure for the other ignition module.

### Remove Flywheel

- Use a flywheel holding tool (a suitable handle may be attached for convenience, refer to Section 2) to hold the flywheel and loosen the hex. flange screw securing the flywheel to the crankshaft. See Figure 9-28.

NOTE: Always use a holding tool to hold the flywheel when loosening or tightening the flywheel screw. Do not use any other type of bar or wedge to hold the flywheel. Use of such tools could cause the flywheel to become cracked or damaged.

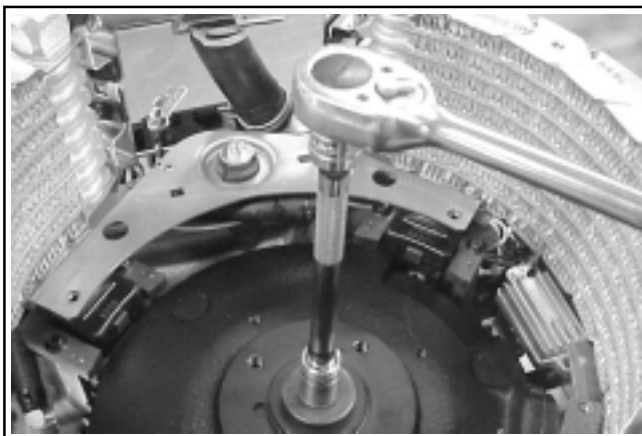


Figure 9-28. Loosening Flywheel.

- Remove the hex. flange screw and washer from the flywheel.
- Use a puller to remove the flywheel from the crankshaft. See Figure 9-29.

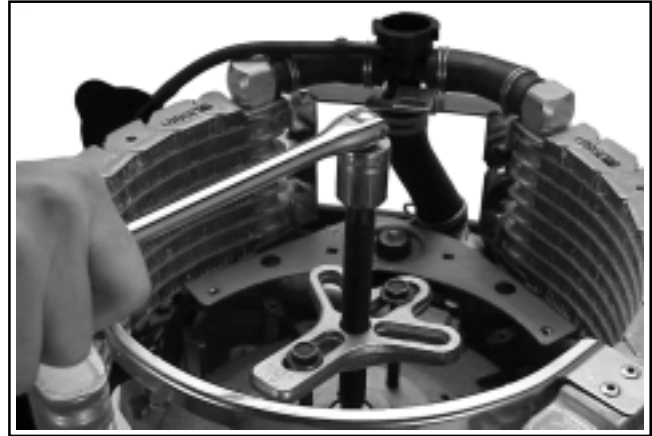


Figure 9-29. Removing Flywheel.

NOTE: Always use a flywheel puller to remove the flywheel from the crankshaft. Do not strike the crankshaft or flywheel, as these parts could become cracked or damaged.

- Work the flywheel out from under the main bracket using the puller as a handle. See Figure 9-30.

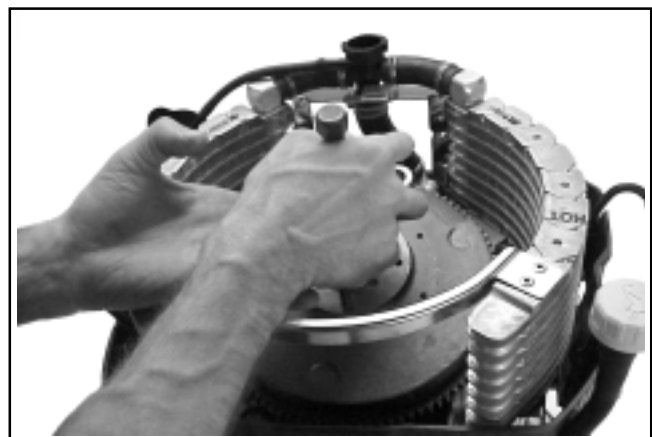


Figure 9-30. Removing Flywheel, Using Puller as a Handle.

- Remove the woodruff key from the crankshaft keyway.

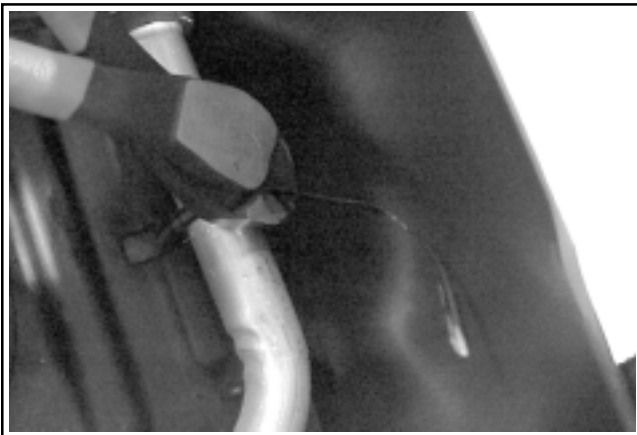
**Remove Radiators and Cooling System**

1. Remove the hex. nut from the center mounting stud, located between the two radiators and through the main support bracket. See Figure 9-31.



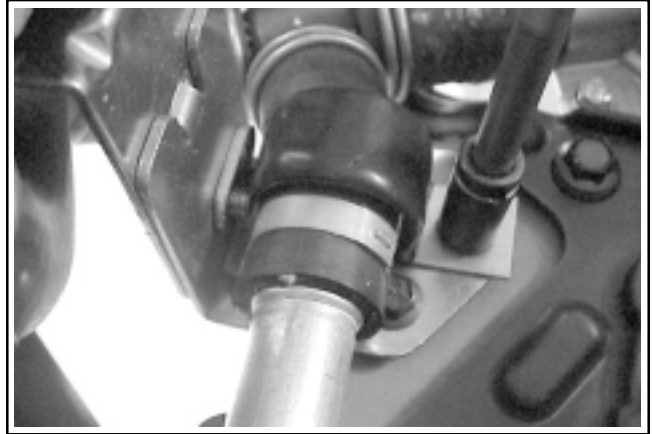
**Figure 9-31. Removing Center Mounting Nut.**

2. Cut the metal tie strap from around the lower hose/tube assembly, secured to the blower housing. See Figure 9-32.



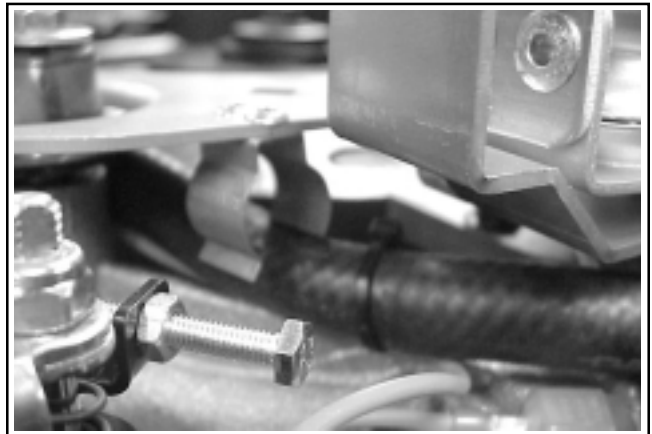
**Figure 9-32. Cutting Tie Strap off.**

3. Remove the two screws attaching the rear support bracket and half clamp to the crankcase, on the oil filter side. See Figure 9-33.



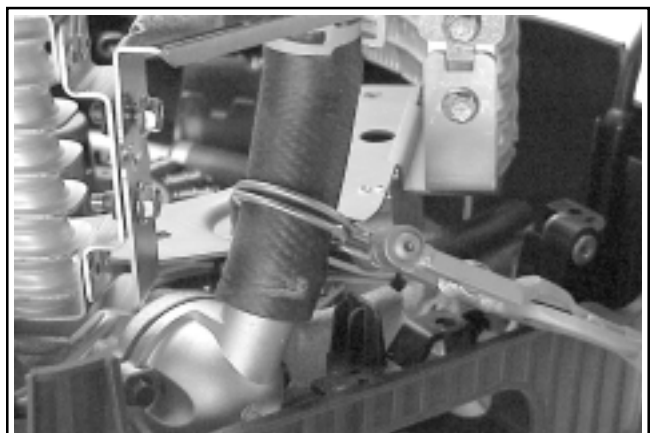
**Figure 9-33. Rear Bracket/Clamp.**

4. Pull the by-pass hose out of the retaining clip beneath the main support bracket. See Figure 9-34.



**Figure 9-34. Unseating By-pass Hose.**

5. Unseat the clamps and separate the hose connections at the outlet of the thermostat housing and the inlet of the water pump. See Figures 9-35, 9-36. Remove the tubular spacer from the underside of center mount, or the mounting stud in intake manifold. See step 1.



**Figure 9-35. Moving Hose Clamp with Special Pliers.**



## Section 9 Disassembly

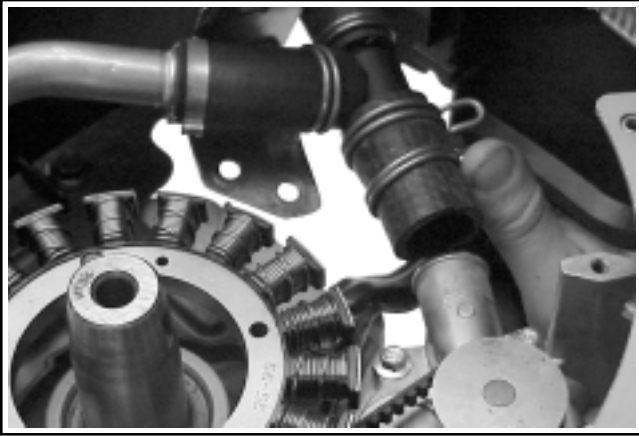


Figure 9-36. Lower Hose Removed.

6. Lift the entire cooling system, with the radiators, hoses, and supporting brackets attached, off the engine. See Figure 9-37. Further disassembly may be performed as required. When disassembly of hose connections is necessary, the use of a rubber lubricant on the inside of hoses will make installation easier.

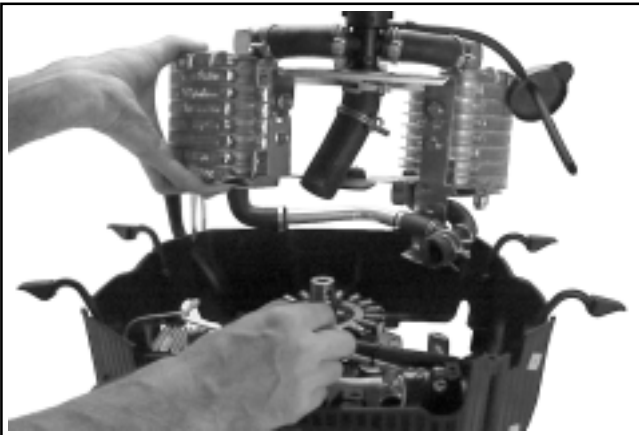


Figure 9-37. Lifting the Cooling System Off.

### Remove Stator and Rectifier-Regulator

1. Remove the two stator mounting screws. See Figure 9-38.

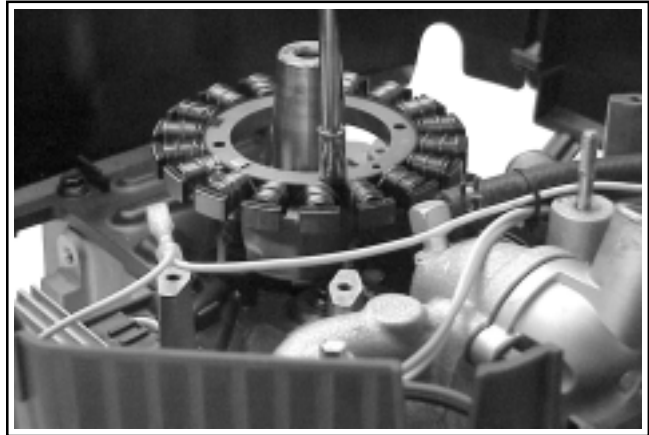


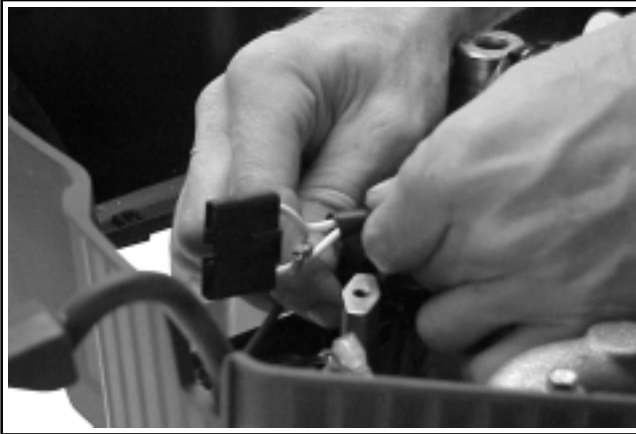
Figure 9-38. Removing Stator.

2. Remove the single screw securing the ground lead and rectifier-regulator. Lift the rectifier-regulator off the locating post. Work the stator leads out from under the retaining tab in the lower housing. See Figure 9-39.



Figure 9-39. Removing Rectifier-Regulator.

3. Unplug the connector from the rectifier-regulator. Using a small screwdriver or other narrow flat blade, bend down the locking tang on the center terminal and pull the B+ charging lead out of the connector. See Figure 9-40.

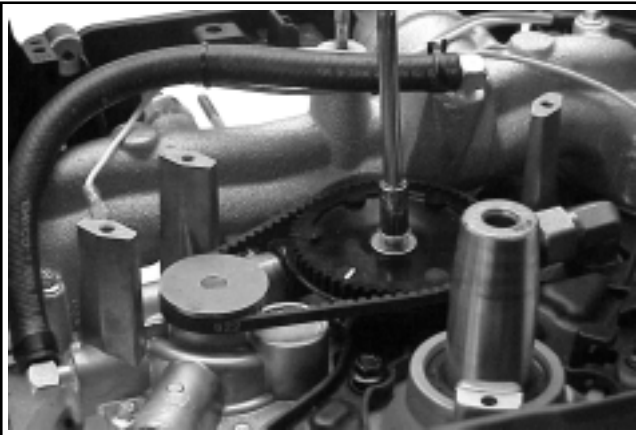


**Figure 9-40. Removing B+ Charging Lead from Connector.**

4. Remove the stator and rectifier-regulator.

### **Remove Cam Pulley and Coolant Pump Belt**

1. Remove the hex. flange screw and flat washer, securing the cogged drive pulley to the camshaft. See Figure 9-41.



**Figure 9-41. Removing Cam Pulley Mounting Hardware.**

2. Lift the pulley off the camshaft and work the belt off the coolant pump pulley. See Figure 9-42.



**Figure 9-42. Removing Cam Pulley and Belt.**

3. Remove the camshaft key from the keyway.

### **Remove Water Pump and Transfer Tube**

1. Unseat the clamp and disconnect the by-pass hose from the water pump fitting. See Figure 9-43.



**Figure 9-43. Removing By-pass Hose from Water Pump Fitting.**

## Section 9

### Disassembly

2. Loosen and unscrew the hex. cap section, securing the transfer tube to the 90° fitting in the crankcase. See Figure 9-44. Support the fitting with a wrench, if possible, when loosening the hex. cap section.

NOTE: The 90° fitting in the crankcase, which the transfer tube is connected to, is sealed and installed at the factory in a specific position. **Do not** loosen, remove, or alter the mounted position of this fitting at any time. Contact the factory service department for specific instructions if the fitting is damaged, or its mounting is affected in any way.



Figure 9-44. Removing Hex. Cap Section.

3. Remove the six screws securing the water pump to the crankcase. See Figure 9-45.

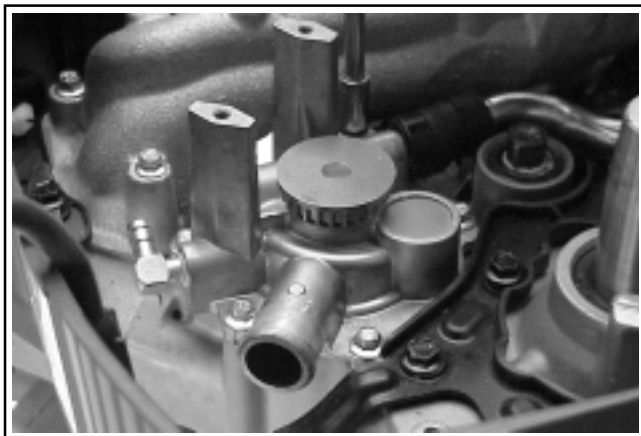


Figure 9-45. Removing the Six Water Pump Screws.

4. Lift the pump up and carefully work the ferruled end of the transfer tube out of the fitting. Remove the water pump with the tube and the hose section attached. Remove the O-Ring from within the channel. See Figure 9-46.



Figure 9-46. Lifting Out Water Pump and Transfer Tube.

5. If required, remove the hose clamps, noting size differences and installed positions with respect to the tangs. This is critical for clearance to the blower housing. Separate the transfer tube, and hose section from the water pump.

### Remove By-pass Hose and Wiring Harness

1. Unseat the clamp and disconnect the coolant by-pass hose from the fitting on the intake manifold. See Figure 9-47.

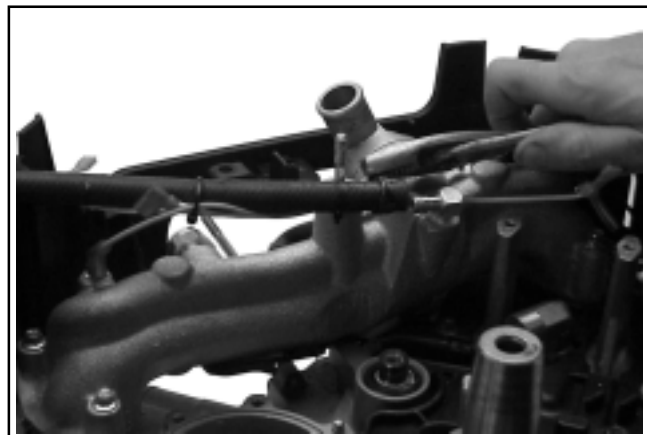
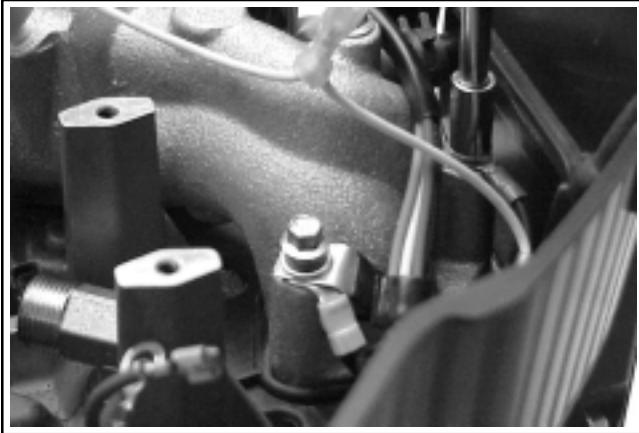


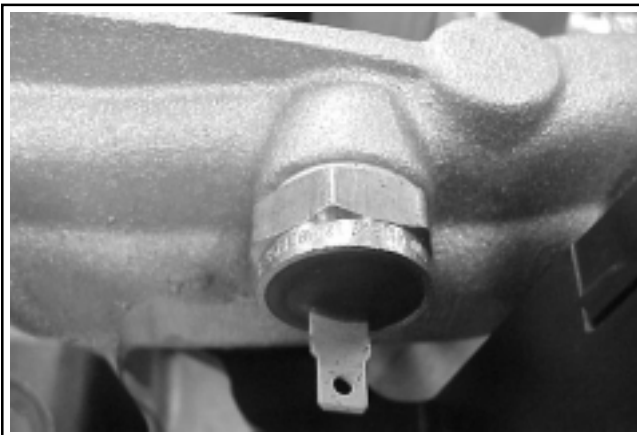
Figure 9-47. Removing Coolant By-pass Hose from Intake Manifold Fitting.

2. Remove the two No. 1 side intake manifold mounting screws securing the ground leads and clip for the wiring harness. Note the locations of the clip and ground leads. See Figure 9-48.



**Figure 9-48. Removing No. 1 Side Intake Manifold Screws with the Ground Leads.**

3. Disconnect the wire leads from the Oil Sentry™ and safety interlock switch, temperature sensor, and/or warning alarm, as equipped. See Figures 9-49 and 9-50.

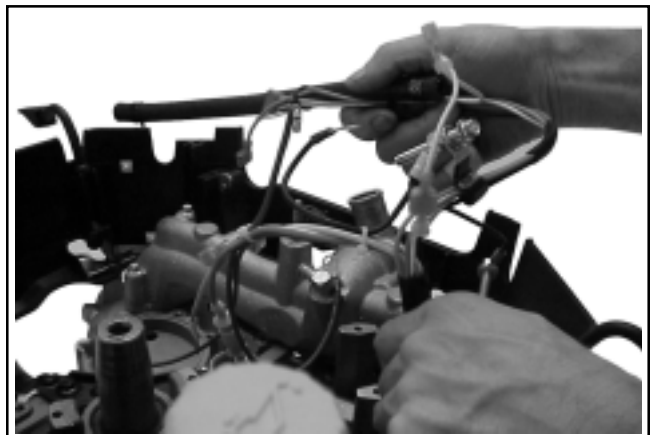


**Figure 9-49. Temperature Sensor.**



**Figure 9-50. Warning Alarm.**

4. Lift the by-pass hose, with the wiring harness attached, and work the ends of the harness back through the openings in the lower blower housing to remove. See Figure 9-51.



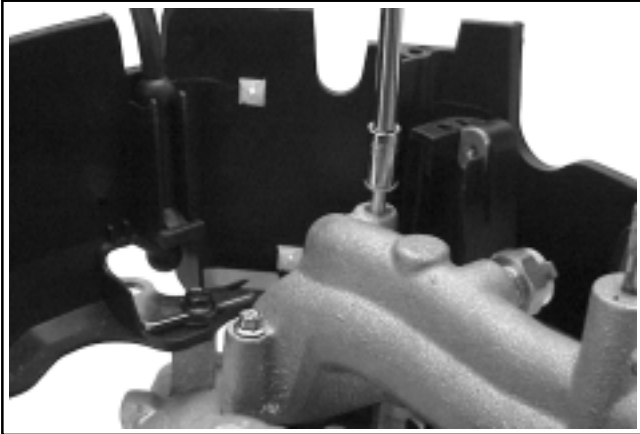
**Figure 9-51. Removing By-pass Hose and Wiring Harness.**

## Section 9

### Disassembly

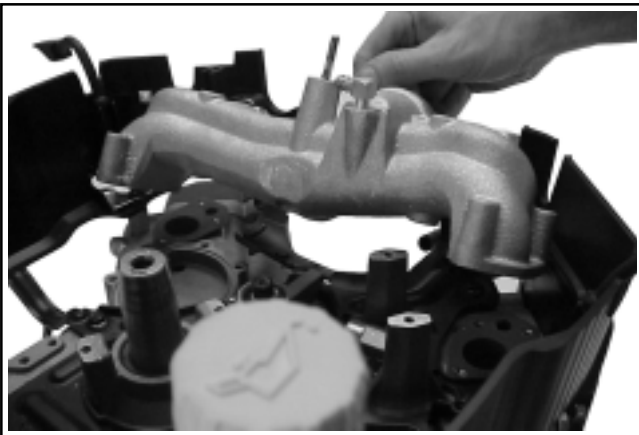
#### Remove Intake Manifold, Temperature Sensor, and Thermostat

1. Remove the four remaining hex. flange screws securing the intake manifold to the cylinder heads. See Figure 9-52.



**Figure 9-52. Removing Remaining Intake Manifold Screws.**

2. Separate the intake manifold from the cylinder heads and remove it, by shifting it toward the crankshaft, until the carburetor studs clear the lower blower housing. Remove the intake manifold gaskets. See Figure 9-53.

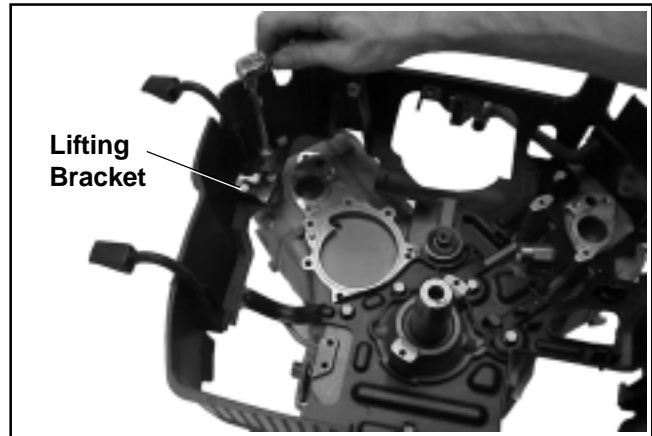


**Figure 9-53. Removing Intake Manifold and Gaskets.**

3. If the thermostat is to be removed, loosen and remove the two hex. flange screws securing the thermostat housing to the intake manifold. Separate the housing and remove the thermostat and the old gasket.

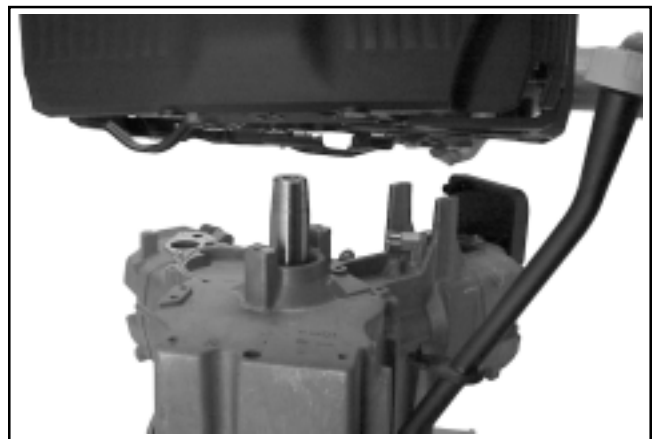
#### Remove Lower Blower Housing and Oil Fill/Dipstick Tube

1. Remove the breather hose from the No. 1 side valve cover fitting.
2. Remove the eight hex. flange thread forming screws securing the lower blower housing to the crankcase. Note the location of the lifting bracket attached to the blower housing mounting screw on the No. 2 side. See Figure 9-54.



**Figure 9-54. Removing the Eight Lower Blower Housing Mounting Screws and Lifting Bracket.**

3. Lift the lower blower housing up and separate the oil fill/dipstick tube from the notch. Remove the blower housing. See Figure 9-55.



**Figure 9-55. Removing Lower Blower Housing.**

4. Clean the crankcase area around the dipstick tube of all dirt and debris. Carefully pull upwards on the tube assembly to unseat and remove it. See Figure 9-56.

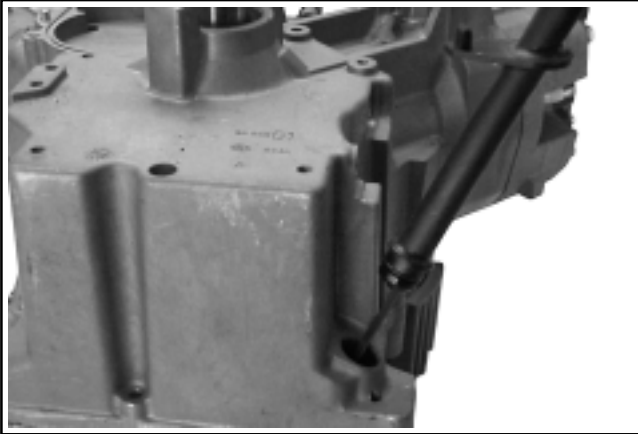


Figure 9-56. Removing Dipstick Tube Assembly.

### Remove Oil Sentry™ (If So Equipped)

1. Remove the Oil Sentry™ switch, from the breather cover. See Figure 9-57.

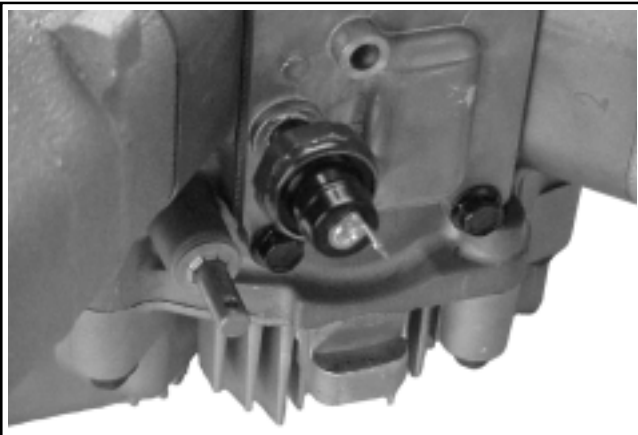


Figure 9-57. Removing Oil Sentry™ Switch.

### Remove Breather Cover

1. Remove the four hex. flange screws securing the breather cover to the crankcase. See Figure 9-58.

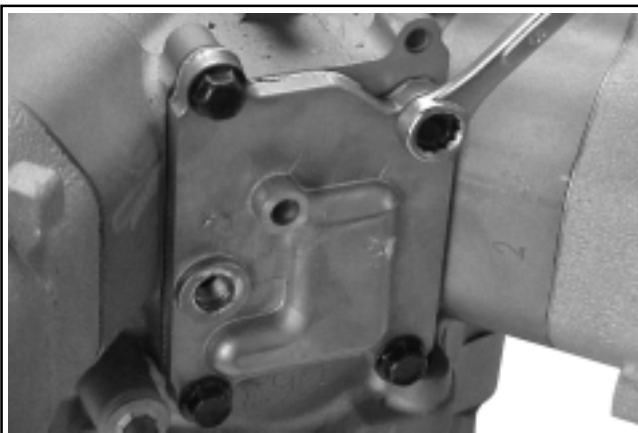


Figure 9-58. Removing Breather Cover Screws.

2. Carefully pry under the protruding edge of the breather cover with a screwdriver to separate the cover. See Figure 9-59. Do not pry on the sealing surfaces as it could cause damage resulting in leaks.

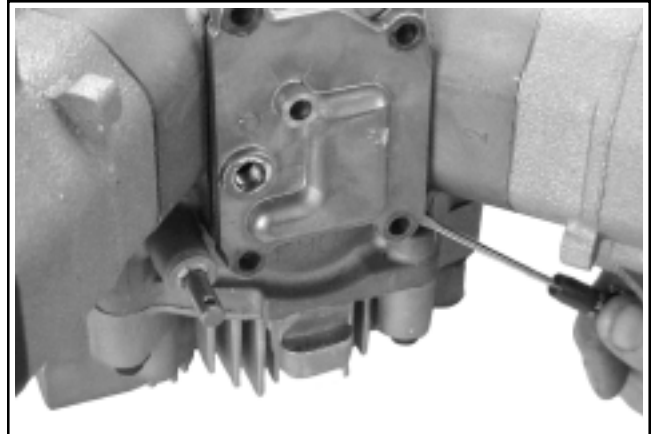


Figure 9-59. Prying Off Breather Cover.

3. Remove the cover and the gasket. See Figure 9-60.

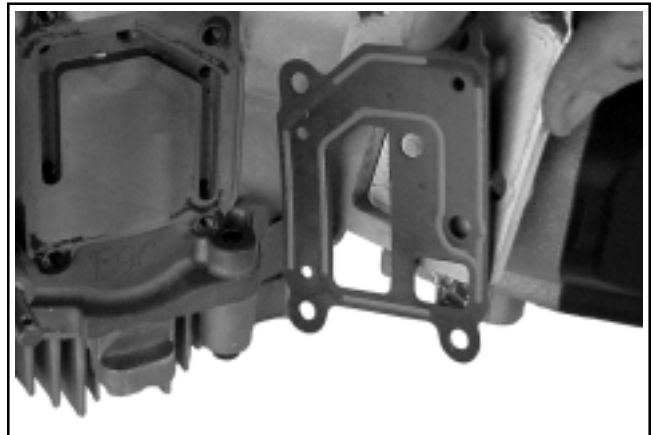


Figure 9-60. Removing Breather Cover and Gasket.

## Section 9 Disassembly

### Remove Spark Plugs

1. Remove the spark plug from each cylinder head using a spark plug socket. See Figure 9-61.

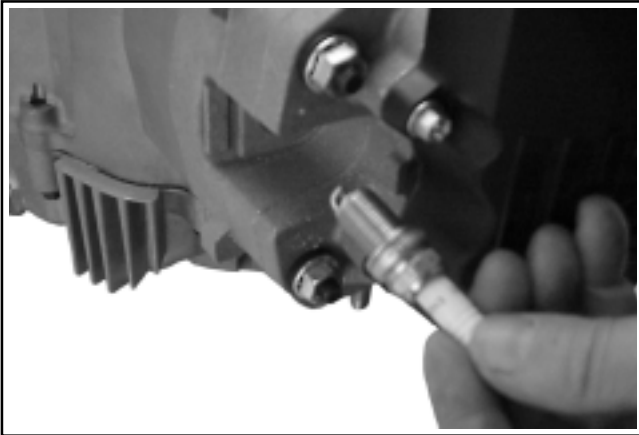


Figure 9-61. Removing Spark Plug(s).

### Remove Valve Covers

1. Remove the four hex. flange screws securing each of the valve covers. Note the differences between the covers, and the lengths of the screws, for proper installation later. See Figure 9-62.

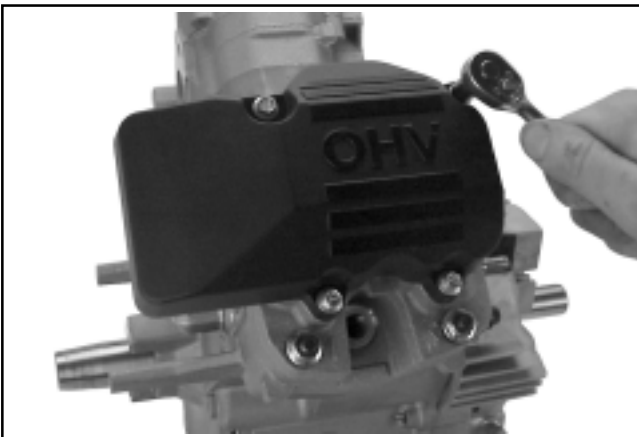


Figure 9-62. Removing Valve Cover Screws.

2. Break the cover/gasket seal by carefully prying under the edges of the cover. Remove the cover and gasket from each side. See Figure 9-63.

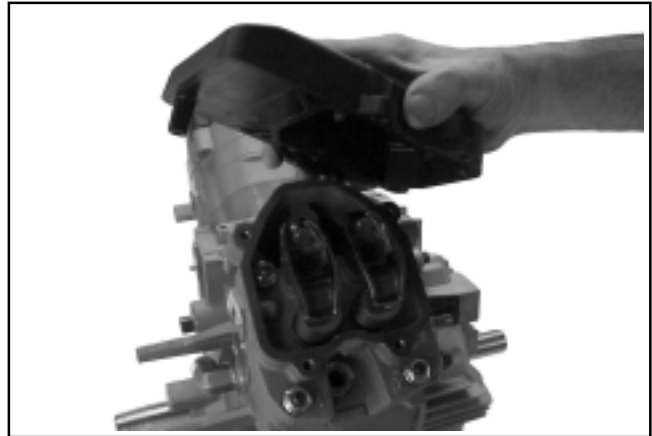


Figure 9-63. Removing the Valve Cover.

### Remove Cylinder Heads and Hydraulic Lifters

1. Rotate the crankshaft until the valves of one of the cylinders are closed. Loosen the rocker arm screws until the rocker arms can be pivoted to free the push rods.
2. Remove and mark the location of the push rods (intake or exhaust) and the respective cylinder (1 or 2). The push rods should always be reinstalled in their original locations. See Figure 9-64.

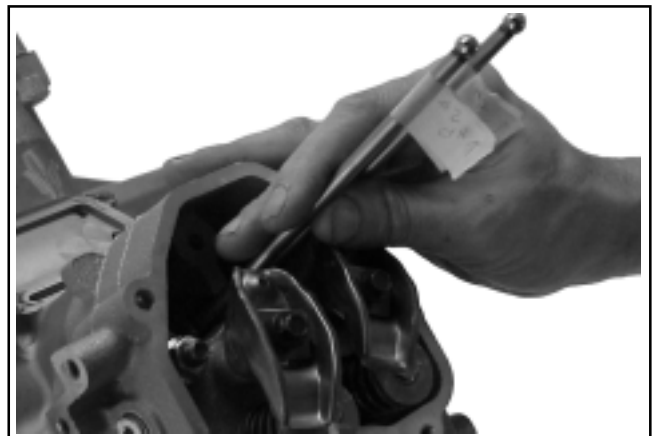
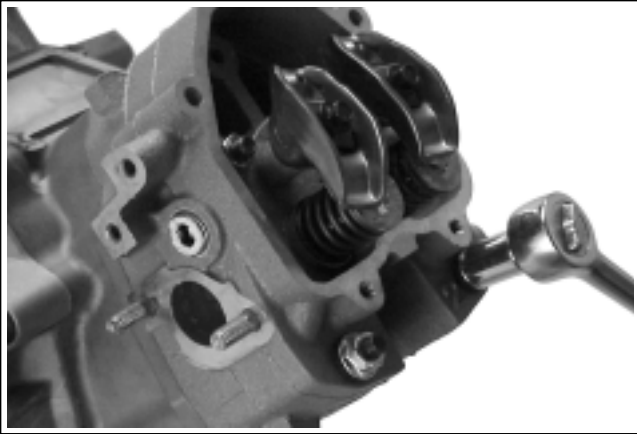


Figure 9-64. Removing Push Rods.

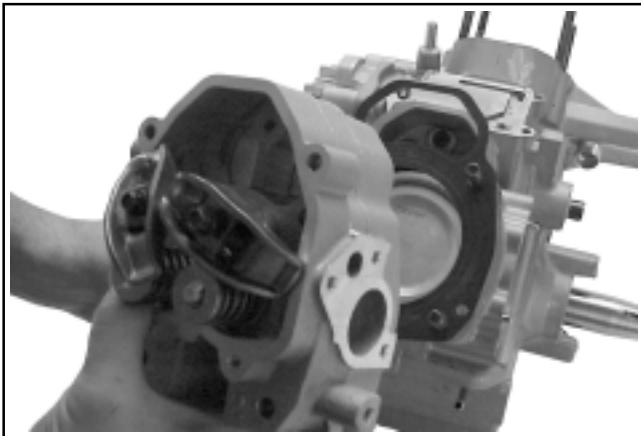
3. Repeat for the opposite cylinder.
4. Remove the four hex. flange nuts and washers from the studs securing each cylinder head. See Figure 9-65.



**Figure 9-65. Removing Hex. Flange Nuts and Washers from Studs.**

5. Carefully remove the cylinder heads, and head gaskets. See Figure 9-66.

**NOTE:** It is not necessary to remove the cylinder studs from the crankcase unless replacement is intended. If studs are removed for any reason, discard the old stud(s), do not reuse/reinstall. Use new studs and refer to the assembly sequence for proper installation.



**Figure 9-66. Removing Cylinder Heads and Gaskets.**

6. Remove and mark the hydraulic lifters corresponding to location (intake or exhaust) and the respective cylinder (1 or 2). Hydraulic lifters should always be reinstalled in their original locations. See Figure 9-67.



**Figure 9-67. Removing Lifters from Lifter Bores.**

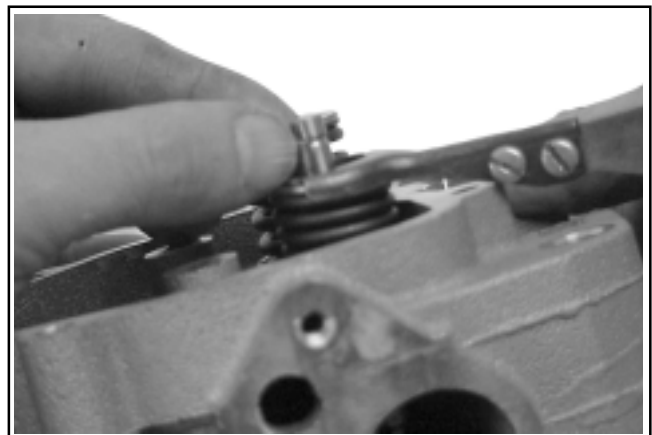
### Disassemble Cylinder Heads

1. Remove the two hex. flange screws, shims, rocker arms and pivots from one of the cylinder heads. See Figure 9-68.



**Figure 9-68. Removing Rocker Arms and Pivots.**

2. Compress the valve springs using a valve spring compressor and remove the valve spring keepers. See Figure 9-69.



**Figure 9-69. Compressing Valve Spring.**



## Section 9 Disassembly

3. With the keepers taken out, the following items can be removed (see Figures 9-70 and 9-71):
  - valve spring retainers
  - valve springs
  - valve spring caps
  - intake and exhaust valves
  - valve stem seals (intake valve only)

NOTE: These engines use a valve stem seal on the intake valves. Always use a new seal when the valves are removed from the cylinder head. Replace the seals if they are deteriorated or damaged in any way. Never reuse an old seal.



Figure 9-70. Valve Components.

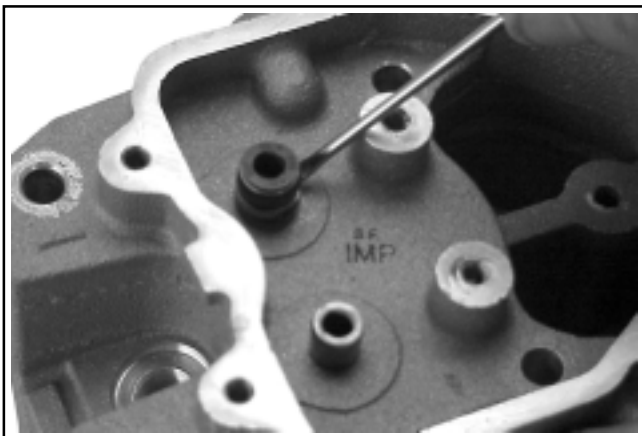


Figure 9-71. Removing Intake Valve Seal.

4. Repeat the above procedure for the other cylinder head. Do not interchange parts from one cylinder head with parts from the other cylinder head.

### Remove Oil Pan Assembly

1. Remove the ten hex. flange screws securing the oil pan to the crankcase. See Figure 9-72. Note the location of the silver plated (grounding) hex. flange screw, to the right of the oil filter boss.

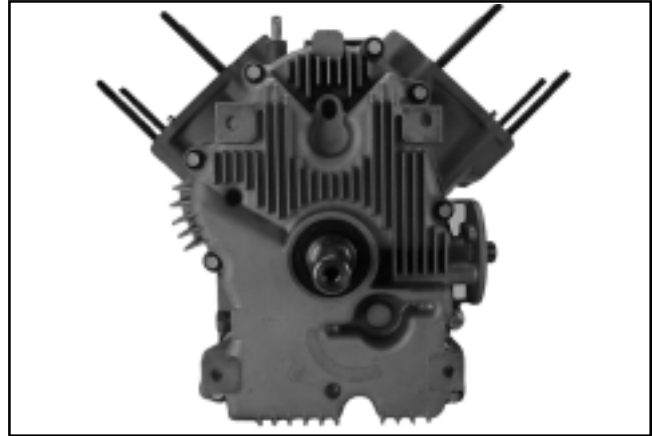


Figure 9-72. Removing Oil Pan Fasteners.

2. Locate the splitting tab cast into the perimeter of the oil pan. Insert the drive end of a breaker bar between the splitting tab and the crankcase, and turn it to break the RTV seal. See Figure 9-73. Do not pry on the sealing surfaces as this can cause leaks.
3. Remove the oil pan from the crankcase.

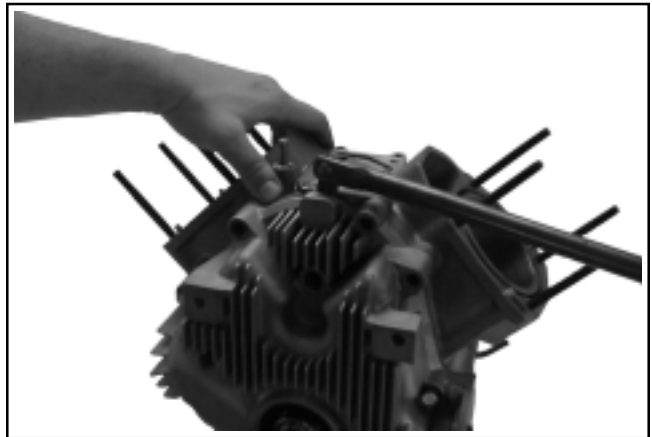


Figure 9-73. Splitting Oil Pan from Crankcase.

### Governor Assembly (Internal)

The governor gear assembly is located inside the oil pan. If service is required, refer to the service procedures under "Governor Assembly" in Section 10.

### Oil Pump Assembly

The oil pump is mounted in the oil pan. If service is required, refer to the service procedures under "Oil Pump Assembly" in Section 10.

### Remove Camshaft

1. Remove the camshaft and shim. See Figure 9-74.

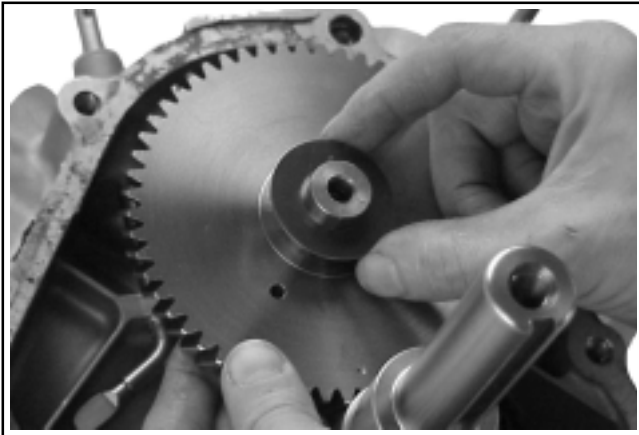


Figure 9-74. Removing Camshaft and Shim.

### Remove Governor Cross Shaft

1. Remove the retaining ring and nylon washer from the governor cross shaft. See Figure 9-75.

**NOTE:** Always use a new retaining ring when reassembling. Do not reuse the old retaining ring.

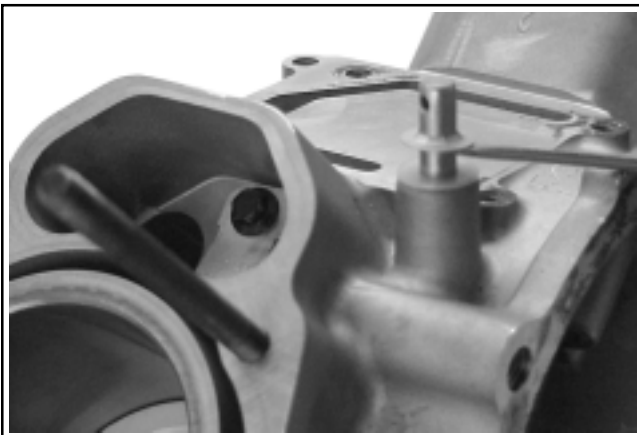


Figure 9-75. Removing Retaining Ring and Nylon Washer.

2. Remove the cross shaft through the inside of the crankcase. Be careful not to lose the small washer on the lower portion of the shaft, just above the stake marks. See Figure 9-76.

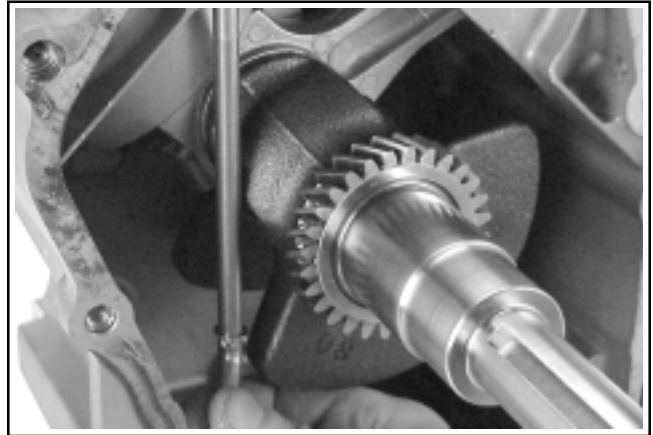


Figure 9-76. Removing Governor Cross Shaft.

### Remove Connecting Rods with Pistons and Rings

1. Remove the two hex. flange screws securing the closest connecting rod end cap. Remove the end cap. See Figure 9-77.

**NOTE:** If a carbon ridge exists at the top of either cylinder bore, use a ridge reamer to remove it before attempting to remove the piston.



Figure 9-77. Removing Connecting Rod End Cap.

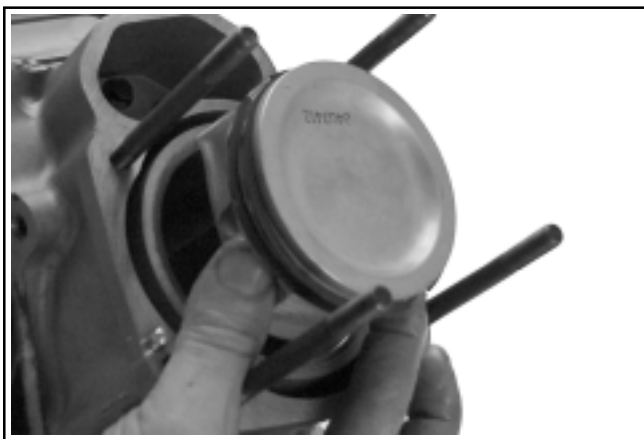
## Section 9

### Disassembly

---

2. Carefully remove the connecting rod and piston assembly from the cylinder bore. See Figure 9-78.

NOTE: The cylinders are numbered on the crankcase. Use the numbers to mark each end cap, connecting rod, and piston for reassembly. Do not mix end caps and connecting rods.

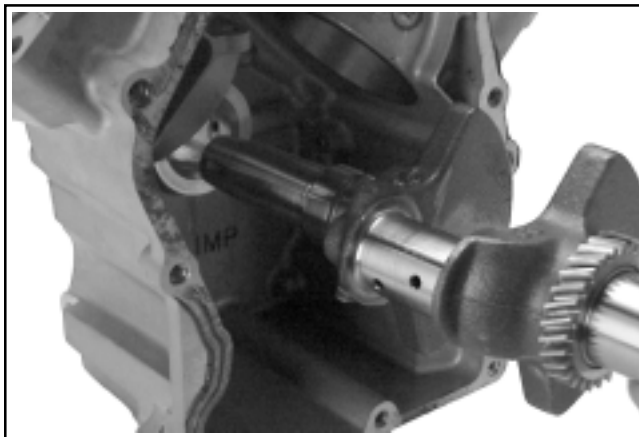


**Figure 9-78. Removing Connecting Rod and Piston Assembly.**

3. Repeat the above procedure for the other connecting rod and piston assembly.

### Remove Crankshaft

1. Carefully pull the crankshaft out of the crankcase. See Figure 9-79.



**Figure 9-79. Removing Crankshaft.**

# Section 10

## Inspection and Reconditioning

This section covers the operation, inspection, and repair/reconditioning of major internal engine components. The following components are not covered in this section. They are covered in sections of their own:

Air Cleaner, Section 4  
Carburetor & External Governor, Section 5  
Ignition, Charging & Electric Starter, Section 8

Clean all parts thoroughly. Only clean parts can be accurately inspected and gauged for wear or damage. There are many commercially available cleaners that will quickly remove grease, oil, and grime from engine parts. When such a cleaner is used, follow the manufacturer's instructions and safety precautions carefully. Make sure all traces of the cleaner are removed before the engine is reassembled and placed into operation. Even small amounts of these cleaners can quickly break down the lubricating properties of engine oil.

Use an aerosol gasket remover or paint remover to remove the old RTV from the crankcase and oil pan. Apply the solvent, give it time to work (5-10 minutes), and then brush the treated surface with a **brass** wire brush to remove the softened RTV. Do not scrape the surfaces when cleaning as this will damage the surfaces and could result in leaks.

Refer to "A Guide to Engine Rebuilding" (TP-2150) for additional information. "Measurement Guide" (TP-2159-A) and "Engine Inspection Data Record" (TP-2435) are also available; use these to record inspection results.

### Camshaft and Crankshaft

#### Inspection and Service

Inspect the gear teeth of the camshaft and crankshaft. If the teeth are badly worn, chipped, or some are missing, replacement will be necessary. If there is tooth damage on either the camshaft gear or crankshaft gear, both the camshaft and crankshaft must be replaced.

Inspect the bearing surfaces for scoring, grooving, etc. Measure the running clearance between the bearing journals and their respective bores. Use an inside micrometer or telescoping gauge to measure the

inside diameter of both bearing bores in the vertical and horizontal planes. Use an outside micrometer to measure the outside diameter of the bearing journals. Subtract the journal diameters from their respective bore diameters to get the running clearances. Check the results against the specifications in Section 1. If the running clearances are within specification, and there is no evidence of scoring, grooving, etc., no further reconditioning is necessary. If the bearing surfaces are worn or damaged, the crankcase and/or oil pan will need to be replaced.

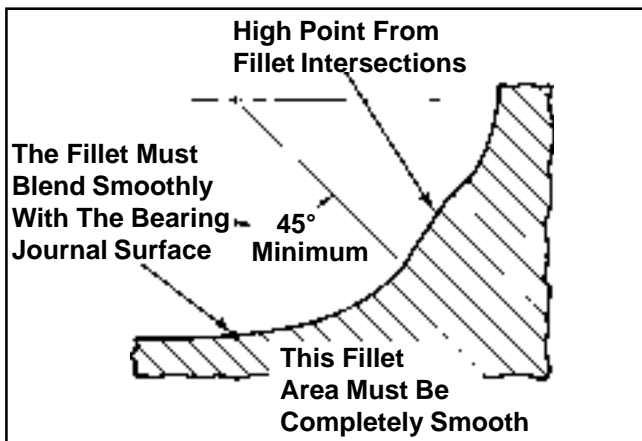
Inspect the crankshaft keyways. If worn or chipped, replacement of the crankshaft will be necessary.

## Section 10

# Inspection and Reconditioning

Inspect the crankpin for score marks or metallic pick up. Slight score marks can be cleaned with crocus cloth soaked in oil. If wear limits, as stated in "Specifications and Tolerances," are exceeded, it will be necessary to either replace the crankshaft or regrind the crankpin to **0.25 mm (0.010 in.)** undersize. If reground, **0.25 mm (0.010 in.)** undersize connecting rods (big end) must then be used to achieve proper running clearance. Measure the crankpin for size, taper, and out-of-round.

**NOTE:** If the crankpin is reground, visually check to ensure that the fillet blends smoothly with the crankpin surface. See Figure 10-1.



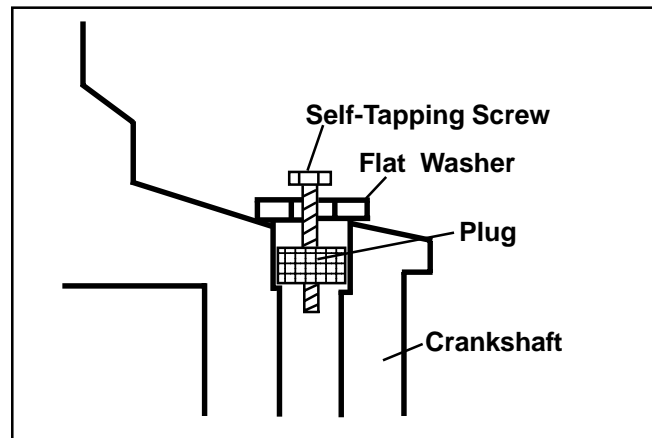
**Figure 10-1. Crankpin Fillets.**

When grinding a crankshaft, grinding stone deposits can get caught in oil passages which could cause severe engine damage. Removing the crankpin plug each time the crankshaft is ground provides easy access for cleaning any grinding deposits that may collect in the oil passages.

Use the following procedure to remove and replace the plug.

### Procedure to Remove Crankshaft Plug:

1. Drill a 3/16" hole through the plug in the crankshaft.
2. Thread a 3/4" or 1" long self-tapping screw with a flat washer into the drilled hole. The flat washer must be large enough to seat against the shoulder of the plug bore. See Figure 10-2.



**Figure 10-2. Removing Crankpin Plug.**

3. Tighten the self-tapping screw until it draws the plug out of the crankshaft.

### Procedure to Install New Plug:

1. Use a single cylinder camshaft pin Kohler Part No. 47 380 09-S as a driver and tap the plug into the plug bore until it seats at the bottom of the bore. Make sure the plug is tapped in evenly to prevent leakage.

### Crankcase

These engines contain a cast-iron cylinder liner that may be reconditioned as follows:

### Inspection and Service

Check all gasket surfaces to make sure they are free of gasket fragments. Gasket surfaces must also be free of deep scratches or nicks.

Check the cylinder bore for scoring. In severe cases, unburned fuel can cause scuffing and scoring of the cylinder wall. It washes the necessary lubricating oils off the piston and cylinder wall. As raw fuel seeps down the cylinder wall, the piston rings make metal to metal contact with the wall. Scoring of the cylinder wall can also be caused by localized hot spots resulting from a cooling system problem or from inadequate or contaminated lubrication.

If the cylinder bore is badly scored, excessively worn, tapered, or out-of-round, resizing is necessary. Use an inside micrometer to determine amount of wear (refer to the "Specifications, Tolerances, and Special Torque Values", in Section 1), then select the nearest suitable oversize of either **0.08 mm (0.003 in.)**, **0.25 mm (0.010 in.)**, or **0.50 mm (0.020 in.)**. Resizing to one of these oversizes will allow usage of the available oversize piston and ring assemblies. Initially, resize using a boring bar, then use the following procedures for honing the cylinder.

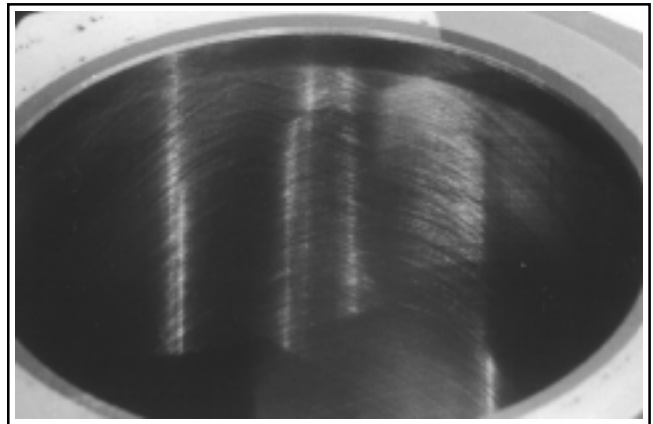
**NOTE:** If the bore is beyond the wear limit, a new miniblock or short block will be required.

### Honing

While most commercially available cylinder hones can be used with either portable drills or drill presses, the use of a low speed drill press is preferred as it facilitates more accurate alignment of the bore in relation to the crankshaft crossbore. Honing is best accomplished at a drill speed of about **250 RPM** and **60 strokes** per minute. After installing coarse stones in hone, proceed as follows:

1. Lower hone into bore and after centering, adjust so that the stones are in contact with the cylinder wall. Use of a commercial cutting-cooling agent is recommended.

2. With the lower edge of each stone positioned even with the lowest edge of the bore, start drill and honing process. Move the hone up and down while resizing to prevent the formation of cutting ridges. Check the size frequently.
3. When the bore is within **0.064 mm (0.0025 in.)** of desired size, remove the coarse stones and replace with burnishing stones. Continue with the burnishing stones until within **0.013 mm (0.0005 in.)** of desired size and then use finish stones (220-280 grit) and polish to final size. A crosshatch should be observed if honing is done correctly. The crosshatch should intersect at approximately 23-33° off the horizontal. Too flat an angle could cause the rings to skip and wear excessively, too steep an angle will result in high oil consumption. See Figure 10-3.



**Figure 10-3. Cylinder Bore Crosshatch After Honing.**

4. After resizing, check the bore for roundness, taper, and size. Use an inside micrometer, telescoping gauge, or bore gauge to take measurements. The measurements should be taken at three locations in the cylinder—at the top, middle, and bottom. Two measurements should be taken (perpendicular to each other) at each of the three locations.

## Section 10

# Inspection and Reconditioning

### Clean Cylinder Bore After Honing

Proper cleaning of the cylinder walls following boring and/or honing is very critical to a successful overhaul. Machining grit left in the cylinder bore can destroy an engine in less than one hour of operation after a rebuild.

The final cleaning operation should always be a thorough scrubbing with a brush and hot, soapy water. Use a strong detergent that is capable of breaking down the machining oil while maintaining a good level of suds. If the suds break down during cleaning, discard the dirty water and start again with more hot water and detergent. Following the scrubbing, rinse the cylinder with very hot, clear water, dry it completely, and apply a light coating of engine oil to prevent rusting.

### Measuring Piston-to-Bore Clearance

Before installing the piston into the cylinder bore, it is necessary that the clearance be accurately checked. This step is often overlooked, and if the clearances are not within specifications, engine failure will usually result.

**NOTE:** Do not use a feeler gauge to measure piston-to-bore clearance—it will yield inaccurate measurements. Always use a micrometer.

Use the following procedure to accurately measure the piston-to-bore clearance:

1. Use a micrometer and measure the diameter of the piston **6 mm (0.24 in.)** above the bottom of the piston skirt and perpendicular to the piston pin. See Figure 10-4.

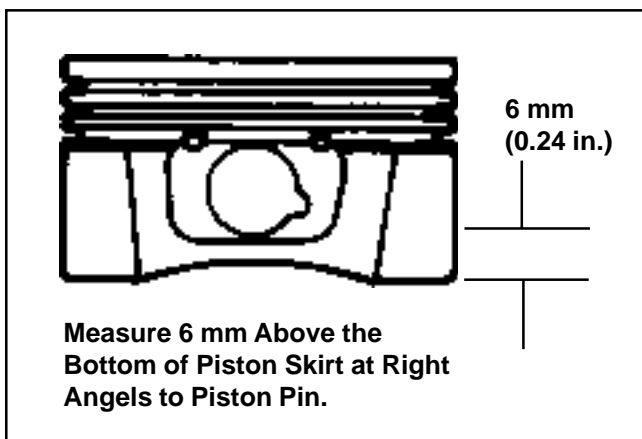


Figure 10-4. Measuring Piston Diameter.

2. Use an inside micrometer, telescoping gauge, or bore gauge and measure the cylinder bore. Take the measurement approximately **63.5 mm (2.5 in.)** below the top of the bore and perpendicular to the piston pin.
3. Piston-to-bore clearance is the difference between the bore diameter and the piston diameter (step 2 minus step 1).

## Flywheel

### Inspection

Inspect the flywheel for cracks, and the flywheel keyway for damage. Replace flywheel if cracked. Replace the flywheel, the crankshaft, and the key if flywheel key is sheared or the keyway is damaged.

Inspect the ring gear for cracks or damage. Kohler does not provide ring gears as a serviceable part. Replace the flywheel if the ring gear is damaged.

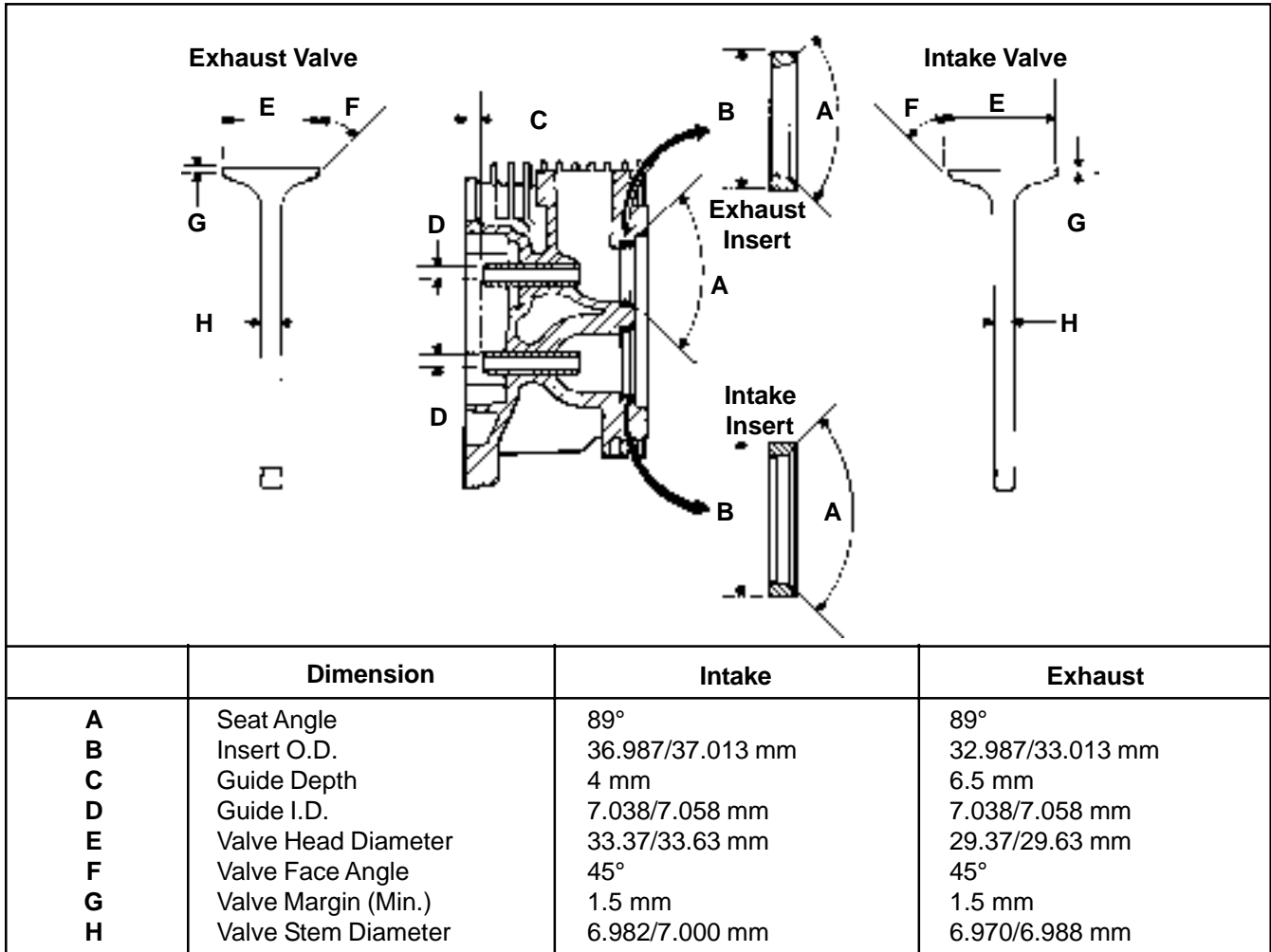
Check the charging system magnets to be sure they are not loose or cracked.

## Cylinder Head and Valves

### Inspection and Service

Carefully inspect the valve mechanism parts. Inspect the valve springs and related hardware for excessive wear or distortion. Check the valves and valve seat area or inserts for evidence of deep pitting, cracks, or distortion. Check clearance of the valve stems in guides. See Figure 10-5 for valve details and specifications.

Hard starting, or loss of power accompanied by high fuel consumption may be symptoms of faulty valves. Although these symptoms could also be attributed to worn rings, remove and check the valves first. After removal, clean the valve heads, faces, and stems with a power wire brush. Then, carefully inspect each valve for defects such as warped head, excessive corrosion, or worn stem end. Replace valves found to be in bad condition. A normal valve and valves in bad condition are shown in the accompanying illustrations.



**Figure 10-5. Valve Details.**



**Normal:** Even after long hours of operation a valve can be reconditioned and reused if the face and margin are in good shape. If a valve is worn to where the margin is less than 1/32" do not reuse it. The valve shown was in operation for almost 1000 hours under controlled test conditions.



**Bad Condition:** The valve depicted here should be replaced. Note the warped head; margin damaged and too narrow. These conditions could be attributed to excessive hours or a combination of poor operating conditions.



## Section 10 Inspection and Reconditioning



**Leakage:** A poor grind on face or seat of valve will allow leakage resulting in a burned valve on one side only.



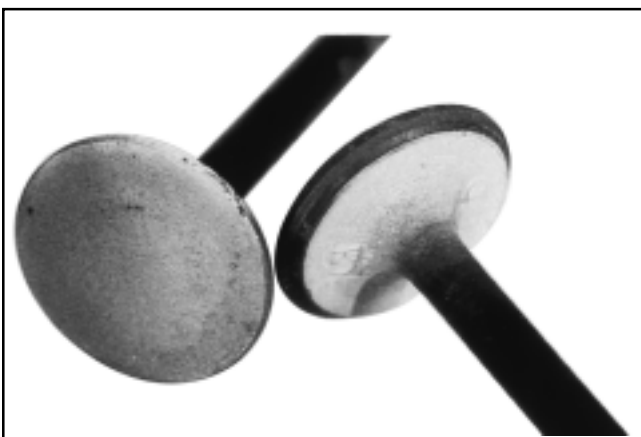
**Gum:** Gum deposits usually result from using stale gasoline. Gum is a prevalent cause of valve sticking. The cure is to ream the valve guides and clean or replace the valves, depending on their condition.



**Stem Corrosion:** Moisture in fuel or from condensation are the most common causes of valve stem corrosion. Condensation occurs from improper preservation during storage and when engine is repeatedly stopped before it has a chance to reach normal operating temperatures. Replace corroded valves.



**Coking:** Coking is normal on intake valves and is not harmful. If the seat is good, the valve could be reused after cleaning.



**Excessive Combustion Temperatures:** The white deposits seen here indicate very high combustion temperatures, usually due to a lean fuel mixture.



**Overheating:** An exhaust valve subject to overheating will have a dark discoloration in the area above the valve guide. Worn guides and faulty valve springs may cause this condition. Also check for clogged air intake, and blocked fins when this condition is noted.

### Valve Guides

If a valve guide is worn beyond specifications, it will not guide the valve in a straight line. This may result in burnt valve faces or seats, loss of compression, and excessive oil consumption.

To check valve guide-to-valve stem clearance, thoroughly clean the valve guide and, using a split-ball gauge, measure the inside diameter. Then, using an outside micrometer, measure the diameter of the valve stem at several points on the stem where it moves in the valve guide. Use the largest stem diameter to calculate the clearance. If the **intake** clearance exceeds **0.038/0.076 mm (0.0015/0.003 in.)** or the **exhaust** clearance exceeds **0.050/0.088 mm (0.0020/0.0035 in.)**, determine whether the valve stem or guide is responsible for the excessive clearance.

Maximum (I.D.) wear on the **intake** valve guide is **7.134 mm (0.2809 in.)** while **7.159 mm (0.2819 in.)** is the maximum allowed on the exhaust guide. The guides are not removable but can be reamed **0.25 mm (0.010 in.)** oversize with Tool No. **KO1026**. Valves with **0.25 mm** oversize stems must then be used.

If the guides are within limits but the valve stems are worn beyond limits, replace with new valves.

### Valve Seat Inserts

Hardened steel alloy intake and exhaust valve seat inserts are press fitted into the cylinder head. The inserts are not replaceable on the engines but can be reconditioned if not too badly pitted or distorted. If cracked or badly warped, the cylinder head should be replaced.

Recondition the valve seat inserts following the instructions provided with the valve seat cutter being used. A typical cutter is shown in Figure 10-6. The final cut should be made with an 89° cutter as specified for the valve seat angle in Figure 10-5. With the proper 45° valve face angle as specified in Figure 10-5 and the valve seat cut properly (44.5° as measured from centerline when cut 89°) this would result in the desired 0.5° (1.0° full cut) interference angle where the maximum pressure occurs on the outside diameters of valve face and seat.

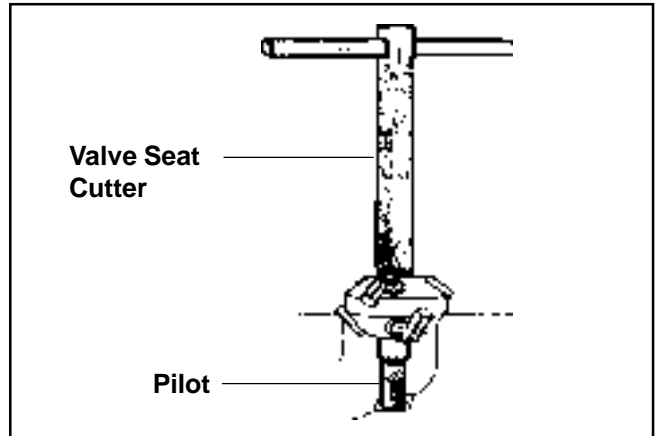


Figure 10-6. Typical Valve Seat Cutter.

### Lapping Valves

Reground or new valves must be lapped in, to provide fit. Use a hand valve grinder with suction cup for final lapping. Lightly coat valve face with "fine" grade of grinding compound, then rotate valve on seat with grinder. Continue grinding until smooth surface is obtained on seat and on valve face. Thoroughly clean cylinder head in soap and hot water to remove all traces of grinding compound. After drying cylinder head, apply a light coating of **SAE 10** oil to prevent rusting.

### Intake Valve Stem Seal

These engines use valve stem seals on the intake valves. Always use a new seal when valves are removed from cylinder head. The seals should also be replaced if deteriorated or damaged in any way. **Never reuse an old seal.**

## Section 10

# Inspection and Reconditioning

### Pistons and Rings

#### Inspection

Scuffing and scoring of pistons and cylinder walls occurs when internal temperatures approach the welding point of the piston. Temperatures high enough to do this are created by friction, which is usually attributed to improper lubrication, and/or overheating of the engine.

Normally, very little wear takes place in the piston boss-piston pin area. If the original piston and connecting rod can be reused after new rings are installed, the original pin can also be reused but new piston pin retainers are required. The piston pin is included as part of the piston assembly. If the pin bosses or the pin, are worn or damaged, a new piston assembly is required.

Ring failure is usually indicated by excessive oil consumption and blue exhaust smoke. When rings fail, oil is allowed to enter the combustion chamber where it is burned along with the fuel. High oil consumption can also occur when the piston ring

end gap is incorrect, because the ring cannot properly conform to the cylinder wall. Oil control is also lost when ring gaps are not staggered during installation.

When cylinder temperatures get too high, lacquer and varnish collect on pistons causing rings to stick which results in rapid wear. A worn ring usually takes on a shiny or bright appearance.

Scratches on rings and pistons are caused by abrasive material such as carbon, dirt, or pieces of hard metal. Detonation damage occurs when a portion of the fuel charge ignites spontaneously from heat and pressure shortly after ignition. This creates two flame fronts which meet and explode to create extreme hammering pressures on a specific area of the piston. Detonation generally occurs from using low octane fuels.

Preignition or ignition of the fuel charge before the timed spark can cause damage similar to detonation. Preignition damage is often more severe than detonation damage. Preignition is caused by a hot spot in the combustion chamber from sources such as glowing carbon deposits, improperly seated valve, or wrong spark plug. See Figure 10-7 for some common types of piston and ring damage.



Figure 10-7. Common Types of Piston and Ring Damage.

Replacement pistons are available in STD bore size, **0.08 mm (0.03 in.)**, **0.25 mm (0.010 in.)**, and **0.50 mm (0.20 in.)** oversizes. Replacement pistons include new piston ring sets and new piston pins. Service replacement piston ring sets are also available separately for STD, **0.08 mm (0.03 in.)**, **0.25 mm (0.010 in.)**, and **0.50 mm (0.020 in.)** oversized pistons. Always use new piston rings when installing pistons. **Never reuse old rings.**

Some important points to remember when servicing piston rings:

1. The cylinder bore must be deglazed before service ring sets are used.
2. If the cylinder bore does not need reboring and if the old piston is within wear limits and free of score or scuff marks, the old piston may be reused.
3. Remove old rings and clean up grooves. **Never reuse old rings.**
4. Before installing the new rings on the piston, place the top two rings, each in turn, in its running area in cylinder bore and check end gap (see Figure 10-8) against the listed specifications below.

### Top and Middle Compression Ring End Gap

#### LV560

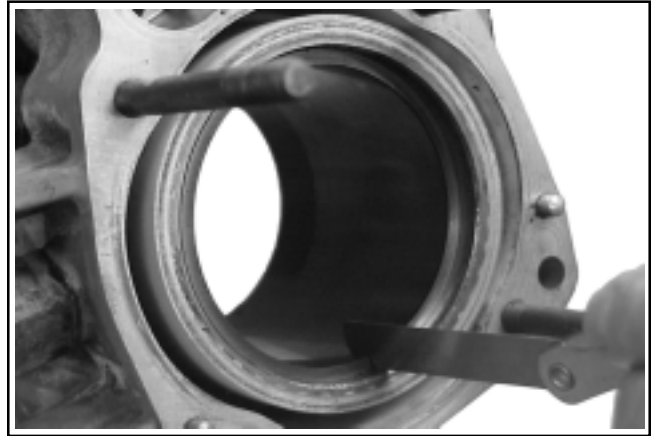
New Bore	
Top Ring .....	0.180/0.380 mm (0.0071/0.0150 in.)
Middle Ring .....	0.180/0.440 mm (0.0071/0.0173 in.)
Used Bore (Max.) 0.76 mm (0.029 in.)	

#### LV625

New Bore	
Top Ring .....	0.180/0.380 mm (0.0071/0.0150 in.)
Middle Ring .....	0.250/0.450 mm (0.0098/0.0177 in.)
Used Bore (Max.) 0.77 mm (0.030 in.)	

#### LV675

New Bore	
Top Ring .....	0.180/0.430 mm (0.0071/0.0169 in.)
Middle Ring .....	0.250/0.460 mm (0.0098/0.0181 in.)
Used Bore (Max.) 0.80 mm (0.0315 in.)	



**Figure 10-8. Measuring Piston Ring End Gap.**

5. After installing the new top and middle compression rings on piston, check piston-to-ring side clearance. Compare finding against the specifications listed below. If clearance is greater than specified, a new piston **must** be used. Refer to Figure 10-9.

#### Top Compression Ring-to-Groove Side Clearance

LV560 .....	0.040/0.096 mm (0.0015/0.0037 in.)
LV625 .....	0.040/0.086 mm (0.0015/0.0034 in.)
LV675 .....	0.050/0.096 mm (0.0019/0.0037 in.)

#### Middle Compression Ring-to-Groove Side Clearance

LV560 .....	0.030/0.080 mm (0.0012/0.0031 in.)
LV625 .....	0.040/0.086 mm (0.0015/0.0034 in.)
LV675 .....	0.030/0.076 mm (0.0012/0.0030 in.)



**Figure 10-9. Measuring Piston Ring Side Clearance.**

## Section 10

# Inspection and Reconditioning

### Install Piston Rings

To install piston rings, proceed as follows:

NOTE: Rings must be installed correctly. Ring installation instructions are usually included with new ring sets. Follow instructions carefully. Use a piston ring expander to install rings (see Figure 10-10). Install the bottom (oil control) ring first and the top compression ring last. Refer to Figure 10-11.



Figure 10-10. Installing Piston Rings With Expander.

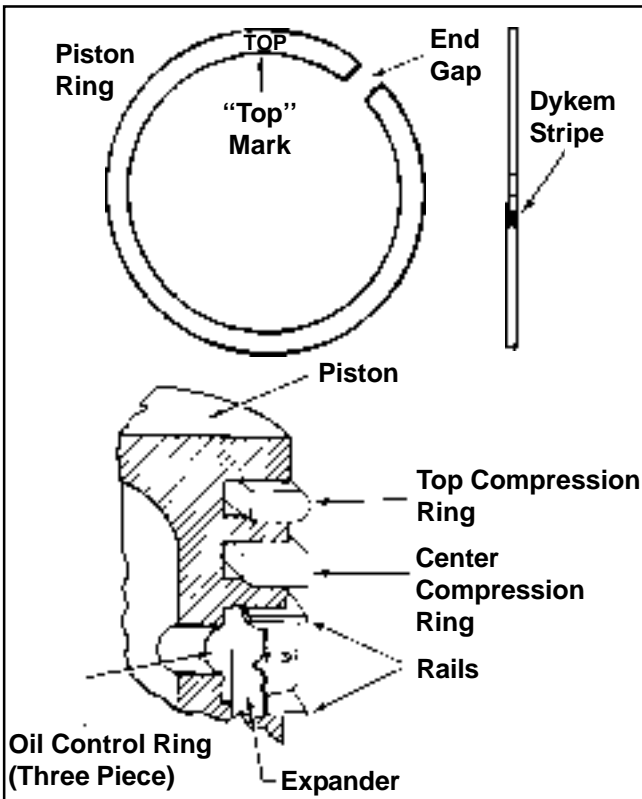


Figure 10-11. Piston Ring Installation.

1. Oil Control Ring (Bottom Groove): Install the expander and then the rails. Make sure the ends of expander are not overlapped.
2. Compression Ring (Center Groove): Install the center ring using a piston ring installation tool. Make sure the “pip” mark is up and the PINK dykem stripe is to the left of end gap.
3. Compression Ring (Top Groove): Install the top ring using a piston ring installation tool. Make sure the “pip” mark is up and the BLUE dykem stripe is to the left of end gap.

### Connecting Rods

Offset Stepped-Cap Connecting Rods are used in all these engines.

#### Inspection and Service

Check bearing area (big end) for excessive wear, score marks, running and side clearances (refer to Section 1, “Specifications, Tolerances, and Special Torque Values”). Replace rod and cap if scored or excessively worn.

Service replacement connecting rods are available in STD crankpin size and **0.25 mm (0.010 in.)** undersize. Always refer to the appropriate parts information to ensure that correct replacements are used.

### Oil Pan Assembly

#### Inspection

Inspect the oil seal in the oil pan and remove it if it is worn or damaged. The new oil seal is installed after the oil pan is assembled to the crankcase. See “Install Oil Seal in Oil Pan” in Section 11.

### Governor Assembly (Internal)

#### Inspection

Inspect the governor gear teeth. Replace the gear if it is worn, chipped, or if any teeth are missing.

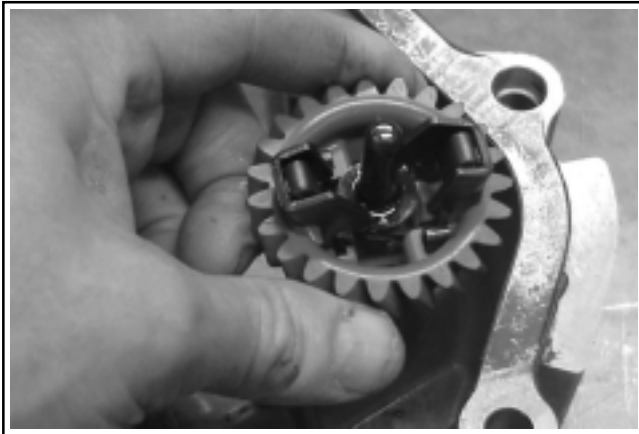
Inspect the governor weights. They should move freely in the governor gear.

#### Disassembly

The governor gear **must** be replaced once it is removed from the oil pan.

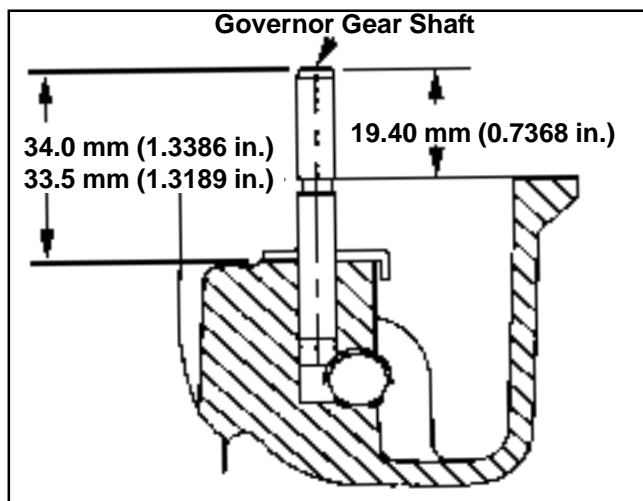
**NOTE:** The governor gear is held onto the shaft by small molded tabs in the gear. When the gear is removed from the shaft, these tabs are destroyed and the gear must be replaced. Therefore, remove the gear **only if** absolutely necessary.

1. Remove the regulating pin and governor gear assembly. See Figure 10-12.



**Figure 10-12. Removing Governor Gear.**

2. Remove the locking tab thrust washer located under the governor assembly.
3. Carefully inspect the governor gear shaft and replace it only if it is damaged. After pulling damaged shaft, press or lightly tap replacement shaft into closure plate to depth shown in Figure 10-13.



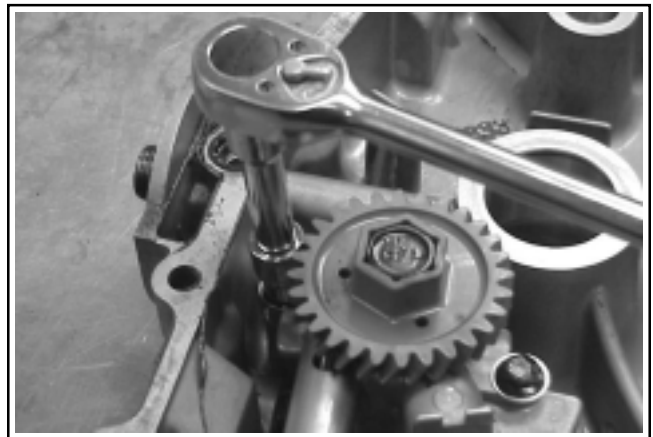
**Figure 10-13. Governor Shaft Press Depth. Reassembly.**

1. Install the locking tab thrust washer on the governor gear shaft with the tab down.
2. Position the regulating pin to the governor gear/flyweights assembly and slide both onto governor shaft.

### Oil Pump Assembly

#### Disassembly

1. Remove the two hex. flange screws.
2. Remove the oil pump assembly from the oil pan.



**Figure 10-14. Removing Oil Pump and Oil Pickup.**

#### Inspection

Inspect the oil pump housing, gear, and rotors for nicks, burrs, wear, or any visible damage. If any parts are worn or damaged, replace oil pump.

#### Reassembly

1. Install the oil pump body to the oil pan and secure with two hex. flange screws. Torque the hex. flange screws to **6.7 N-m (60 in. lb.)**.
2. After torquing, rotate gear for freedom of movement. Make sure there is no binding of pump. If binding occurs, loosen screws, reposition pump, retorque, and recheck movement.

#### Governor Cross Shaft Oil Seal

If the governor cross shaft seal is damaged and/or leaks, replace it using the following procedure.

Remove the oil seal from the crankcase and replace it with a new one. Install the new seal to depth shown in Figures 10-15, 10-16, and 10-17.

## Section 10 Inspection and Reconditioning

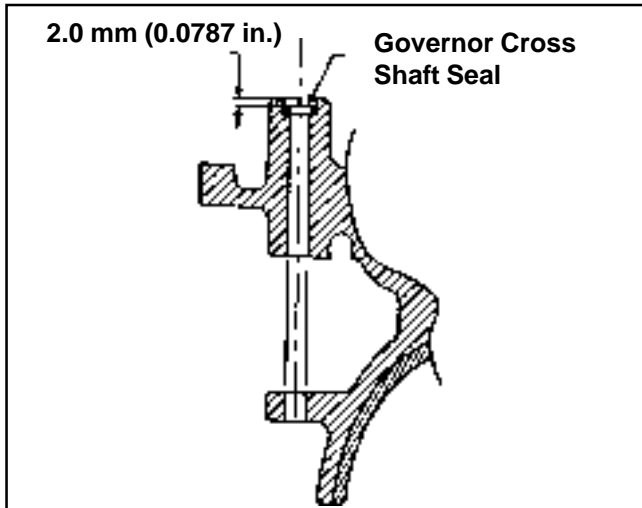


Figure 10-15. Installing Cross Shaft Oil Seal.

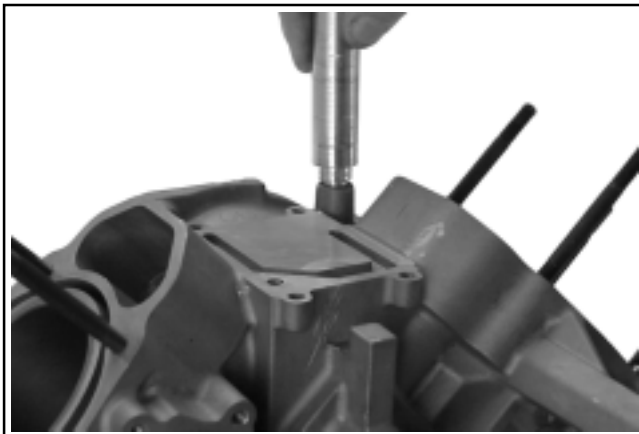


Figure 10-16. Governor Shaft Seal Installation.

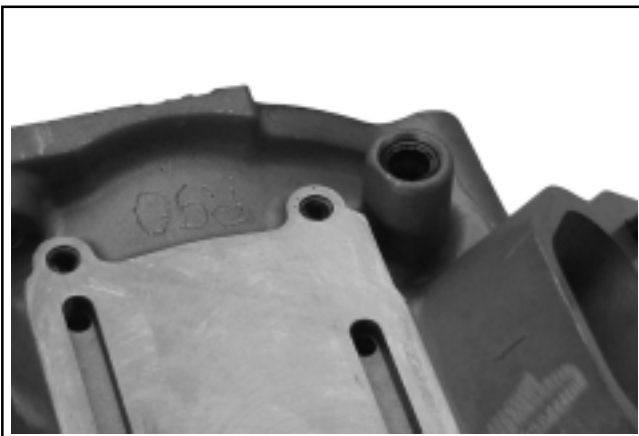


Figure 10-17. Governor Shaft Seal Position.

### Water Pump

The water/coolant pump consists of a sealed impeller assembly, which includes the outer cover and a cogged drive pulley. When the pump is mounted to the crankcase, the impeller fits into a cast recess, and the cover seals against an O-Ring outside the perimeter of the recess.



Figure 10-18. Water Pump.

The impeller assembly is not serviceable, but it should be inspected for wear or damage.

1. Inspect the impeller to make sure the blades are in good condition and free of any cracks, nicks, or damage.
2. The impeller shaft should rotate smoothly, without binding or wobbling, and there should be no sign that coolant has leaked past the shaft to the outer surface of the cover.
3. Check that the drive pulley is not cracked or damaged in any way.

If your inspection causes you to doubt its reliability, the impeller assembly should be replaced. Always use a new O-Ring whenever the water pump is removed. **Do not** reuse the old O-Ring or try to use RTV in its place.

# Section 11

## Reassembly

### General

**NOTE:** Make sure the engine is assembled using all specified torque values, tightening sequences, and clearances. Failure to observe specifications could cause severe engine wear or damage. Always use new gaskets, seals, and O-Rings.

Make sure all traces of any cleaner are removed before the engine is assembled and placed into operation. Even small amounts of these cleaners can quickly break down the lubricating properties of engine oil.

Check the oil pan and crankcase to be certain that all of the old RTV has been removed. Use gasket remover, lacquer thinner, or paint remover to remove any remaining traces.

### Typical Reassembly Sequence

The following sequence is suggested for complete engine reassembly. This procedure assumes that all components are new or have been reconditioned, and all component subassembly work has been completed. The sequence may vary to accommodate options or special equipment. Detailed procedures can be found in subsequent subsections.

1. Install flywheel end oil seal and camshaft seal.
2. Install crankshaft.
3. Install connecting rods with pistons and rings.
4. Install governor cross shaft.
5. Install camshaft.
6. Install oil seal in oil pan.
7. Install oil pan assembly.
8. Install cylinder studs.
9. Install hydraulic lifters.
10. Install cylinder heads and set valve lash.
11. Install breather cover.
12. Install oil fill/dipstick tube and lower blower housing.

13. Install intake manifold and coolant by-pass hose with wiring harness.
14. Install water pump, drive belt and transfer tube.
15. Install stator and rectifier-regulator.
16. Install radiators, cooling system and hoses.
17. Install electric starter.
18. Install ignition modules and flywheel.
19. Install spark plugs.
20. Install overflow reservoir.
21. Install blocking plates and fan.
22. Install valve covers.
23. Install carburetor.
24. Install external governor controls.
25. Install throttle controls.
26. Install fuel pump.
27. Install air cleaner base.
28. Install muffler.
29. Install oil filter.
30. Fill with oil.
31. Fill cooling system.
32. Reconnect battery and spark plug leads.

### Install Flywheel End Oil Seal and Camshaft Seal

1. Check to make sure that there are no nicks or burrs in the crankshaft and camshaft seal bores of the crankcase.
2. Apply a light coat of engine oil to the outside diameter of the oil seal.
3. Install the oil seals into the crankcase using a seal driver. Make sure the oil seals are installed straight and true in their respective bores.

The crankshaft seal should be installed so that the tool bottoms against the crankcase. See Figure 11-1.



## Section 11 Reassembly

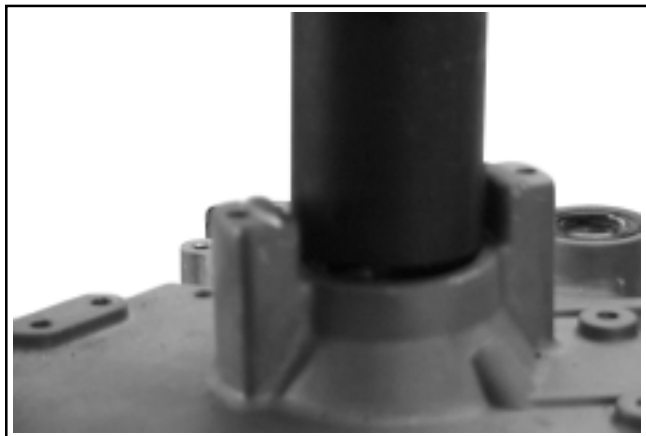


Figure 11-1. Installing Flywheel End Oil Seal in Crankcase.

The camshaft seal should be installed to a depth of **1-1.5 mm (.039-.059 in.)** below the top of the seal bore. See Figure 11-2. **Do not bottom** the seal in the bore or the oil passage may be obstructed.

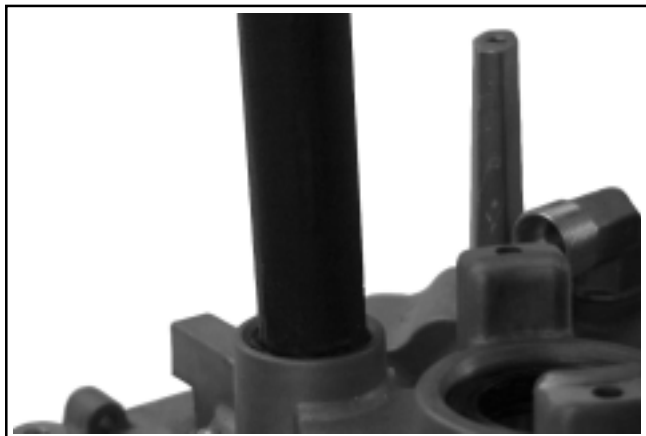


Figure 11-2. Installing Camshaft Seal.

### Install Crankshaft

1. Lubricate the bearing surfaces of the crankcase and crankshaft with engine oil.
2. Carefully slide flywheel end of crankshaft through the bearing bore in crankcase. See Figure 11-3.

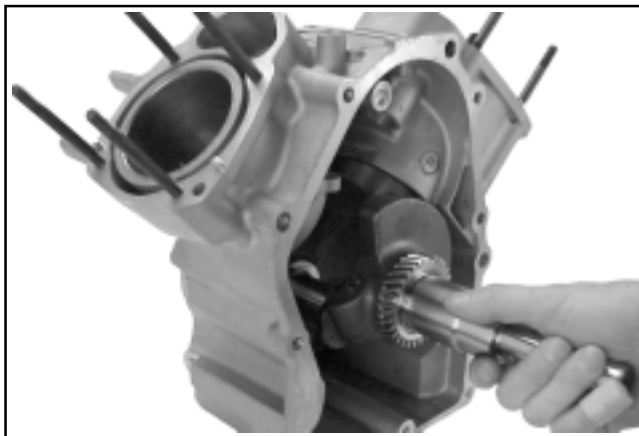


Figure 11-3. Installing Crankshaft.

### Install Connecting Rods with Pistons and Rings

**NOTE:** The cylinders are numbered on the crankcase. Make sure to install piston, connecting rod, and end cap into its appropriate cylinder bore as previously marked at disassembly. Do not mix end caps and connecting rods.

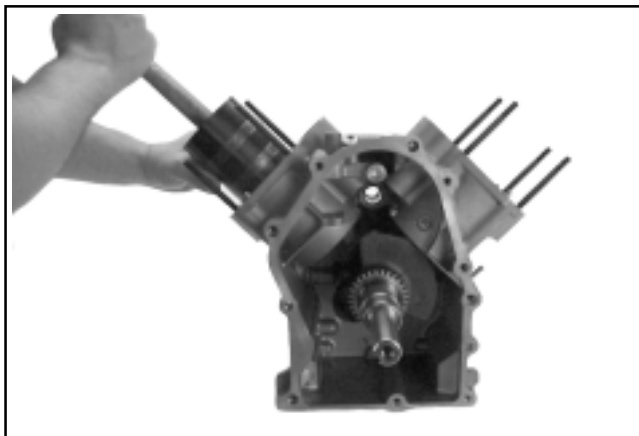
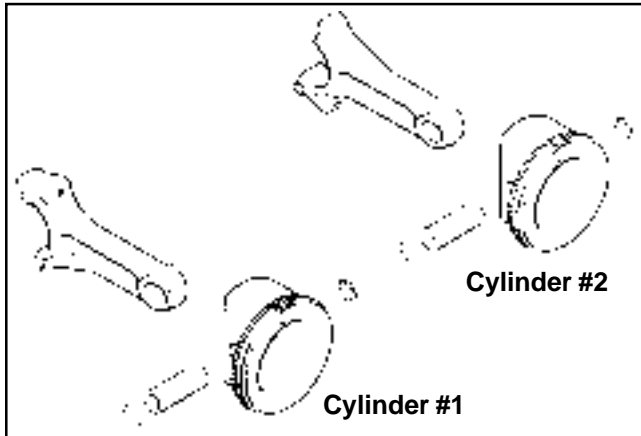


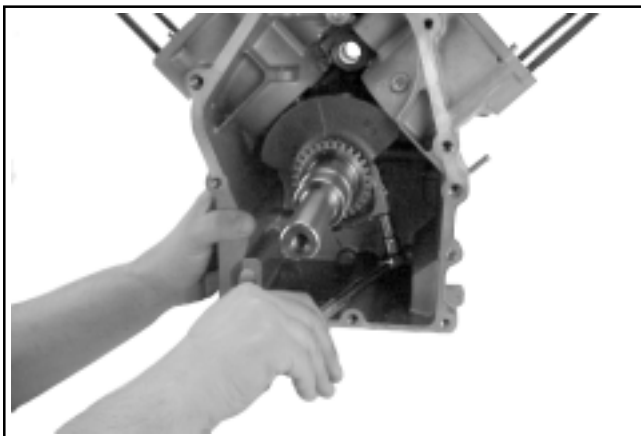
Figure 11-4. Installing Piston (#1) in Bore.

**NOTE:** Proper orientation of the piston/connecting rod assemblies inside the engine is extremely important. Improper orientation can cause extensive wear or damage. Be certain the pistons and connecting rods are assembled exactly as shown in Figure 11-5.



**Figure 11-5. Proper Piston Connecting Rod Orientation.**

1. Stagger the piston rings in the grooves. The end gaps of the top two rings should be 180° apart and perpendicular to the rail end gaps, which should also be 180° apart.
2. Lubricate cylinder bore, piston, and piston rings with engine oil. Compress the rings using a piston ring compressor.
3. Lubricate the crankshaft journals and connecting rod bearing surfaces with engine oil.
4. Make sure “Fly” stamping on piston is facing towards the flywheel side of the engine. Using the grip end of a rubber grip hammer, bump the piston down into the bore. **Do not pound on piston.**
5. Install the inner rod cap to the connecting rod using the two 6 mm straight shank hex. flange screws. Torque the screws in increments to **11.3 N·m (100 in. lb.)**. Illustrated instructions are also provided in the service rod package.



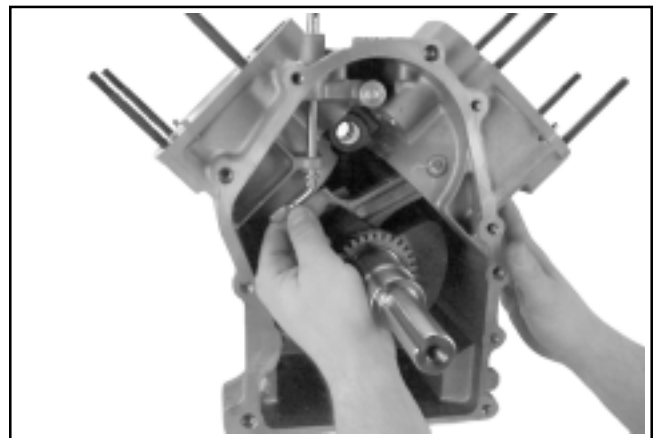
**Figure 11-6. Torquing Rod Cap Bolts.**

**NOTE:** Make sure to align the chamfer of the connecting rod with the chamfer of its mating end cap. The chamfer should be toward the outside.

6. Repeat the above procedure for the other connecting rod and piston assembly.

### Install Governor Cross Shaft

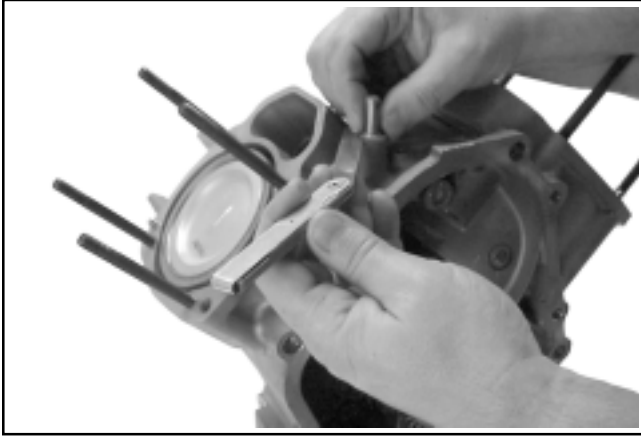
1. Lubricate the governor cross shaft bearing surfaces in the crankcase with engine oil.
2. Slide the small lower washer onto the governor cross shaft and install the cross shaft from the inside of the crankcase. See Figure 11-7.



**Figure 11-7. Installing Governor Cross Shaft from the Inside.**

3. Install the nylon washer onto the governor cross shaft, then start the push-on retaining ring. Hold the governor shaft up in position, place a **0.25 mm (0.010 in.)** feeler gauge on top of the nylon washer, and push the retaining ring down the shaft to secure. Remove the feeler gauge, which will have established the proper end play. See Figure 11-8.

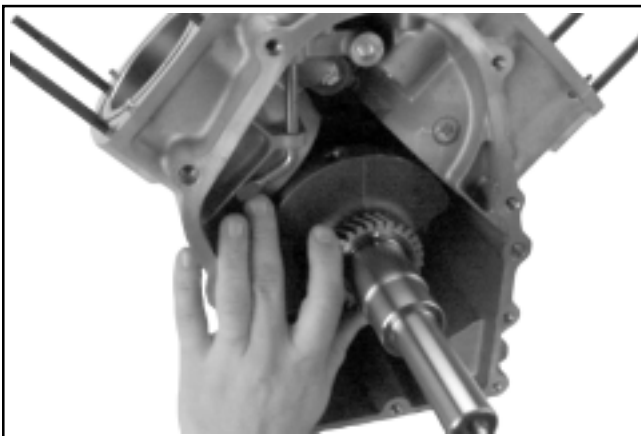
## Section 11 Reassembly



**Figure 11-8. Assembly of Nylon Washer, Retainer, and Setting the End play.**

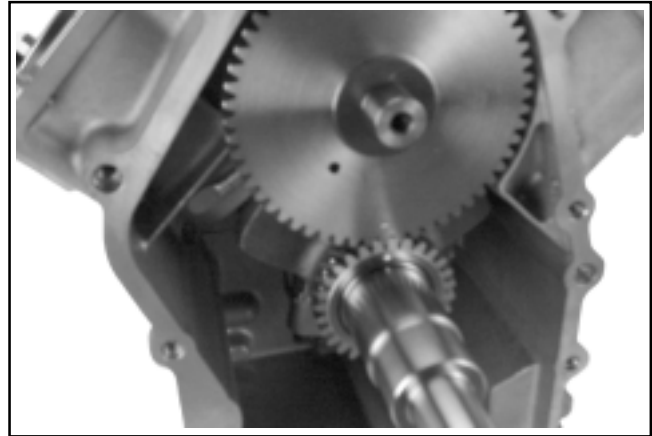
### Install Camshaft

1. Inspect the edges of the keyway in the end of camshaft and make sure they are not nicked or burred. Wrap this end using cellophane tape, so the keyway is covered, to protect the seal from being cut when the camshaft is installed.
2. Lubricate the camshaft bearing surfaces of the crankcase and camshaft with engine oil. Apply a small amount of grease to the lips of camshaft oil seal.
3. Position the timing mark of crankshaft gear at the 12 o'clock position.
4. Turn the governor cross shaft to the left until the lower end of the shaft contacts the crankcase. Make sure the cross shaft stays in this position while installing the camshaft. See Figure 11-9.

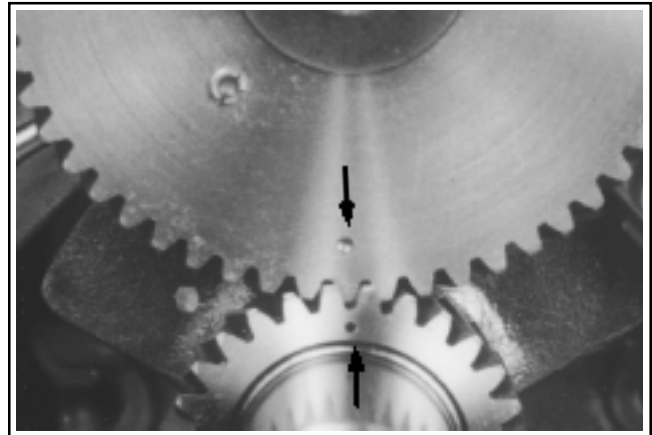


**Figure 11-9. Showing Cross Shaft Position.**

5. Carefully slide the keyway end of the camshaft through the seal and engage the camshaft into the bearing surface of the crankcase. Position the timing mark of camshaft gear at the 6 o'clock position matching the timing mark on the crankshaft. Make sure the camshaft gear and crankshaft gear mesh and the timing marks are aligned as shown in Figures 11-10 and 11-11.



**Figure 11-10. Alignment of Timing Marks.**



**Figure 11-11. Aligning Crankshaft and Camshaft Timing Marks.**

6. Leave the cellophane tape over the keyway until the water pump and drive parts are installed.

## Determining Camshaft End Play

1. Install the shim removed during disassembly onto the camshaft.
2. Position the camshaft end play checking tool on the camshaft. See Figure 11-12.

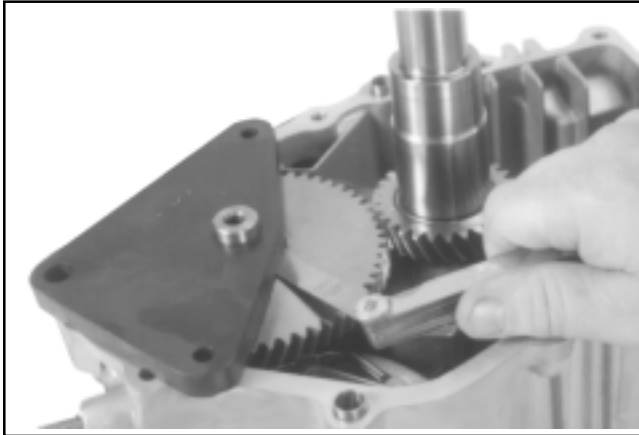


Figure 11-12. Checking Camshaft End Play.

3. Apply pressure on the end play tool, pushing the camshaft toward the crankshaft. Use a feeler gauge to measure the camshaft end play between the shim spacer and the end play tool. Camshaft end play should be **0.076/0.127 mm (0.003/0.005 in.)**.
4. If the camshaft end play is not within the specified range, remove the end play tool and replace shim as necessary.

Several color coded shims are available.

**White:** 0.69215/0.73025 mm (0.02725/0.02875 in.)

**Blue:** 0.74295/0.78105 mm (0.02925/0.03075 in.)

**Red:** 0.79375/0.83185 mm (0.03125/0.03275 in.)

**Yellow:** 0.84455/0.88265 mm (0.03325/0.03475 in.)

**Green:** 0.89535/0.99345 mm (0.03525/0.03675 in.)

**Gray:** 0.94615/0.98425 mm (0.03725/0.03875 in.)

**Black:** 0.99695/1.03505 mm (0.03925/0.04075 in.)

5. Reinstall the camshaft end play checking tool and recheck end play.
6. Repeat steps 4 and 5 until end play is within specified range.

## Oil Pump Assembly

The oil pump is mounted in the oil pan. If service was required, and the oil pump was removed, refer to the assembly procedures under “Oil Pump Assembly” in Section 10.

## Governor Assembly

The governor assembly is located inside the oil pan. If service was required, and the governor was removed, refer to the assembly procedures under “Governor Assembly” in Section 10.

## Install Oil Seal in Oil Pan

1. Check to make sure that there are no nicks or burrs in the crankshaft bore of the oil pan.
2. Apply a light coat of engine oil to the outside diameter of the oil seal.
3. Drive the oil seal into the oil pan using a seal driver. Make sure the oil seal is installed straight and true in bore and that the tool bottoms against the oil pan. See Figure 11-13.

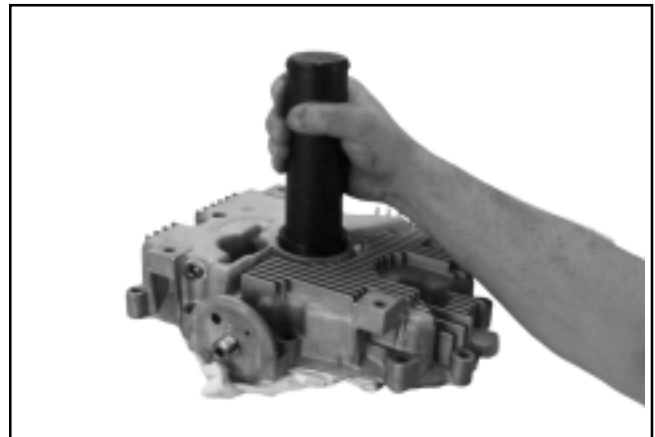


Figure 11-13. Installing Oil Pan Seal.

## Install Oil Pan Assembly

RTV silicone sealant is used as a gasket between the oil pan and the crankcase.

**NOTE:** Always use fresh sealant. Using outdated sealant can result in leakage.

1. Prepare the sealing surfaces of the crankcase and oil pan as directed by the sealant manufacturer.
2. Check to make sure that there are no nicks or burrs on the sealing surfaces of the oil pan or crankcase.

## Section 11 Reassembly

3. Install the O-Ring in groove as shown. See Figure 11-14. Apply a 1.5 mm (1/16 in.) bead of sealant to the sealing surface of the oil pan. See Figure 11-15 for the sealant pattern.

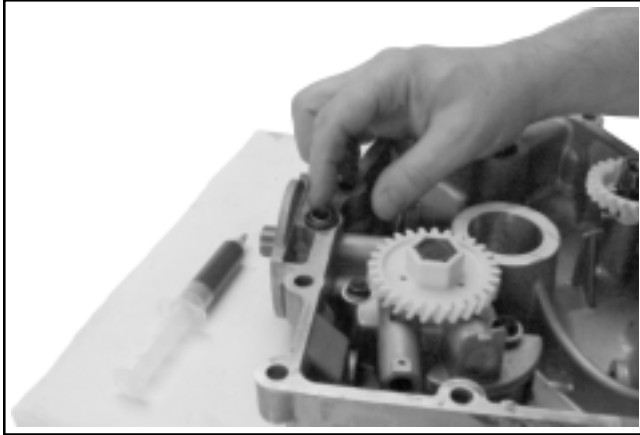


Figure 11-14. Installing O-Ring in Groove of Oil Pan.

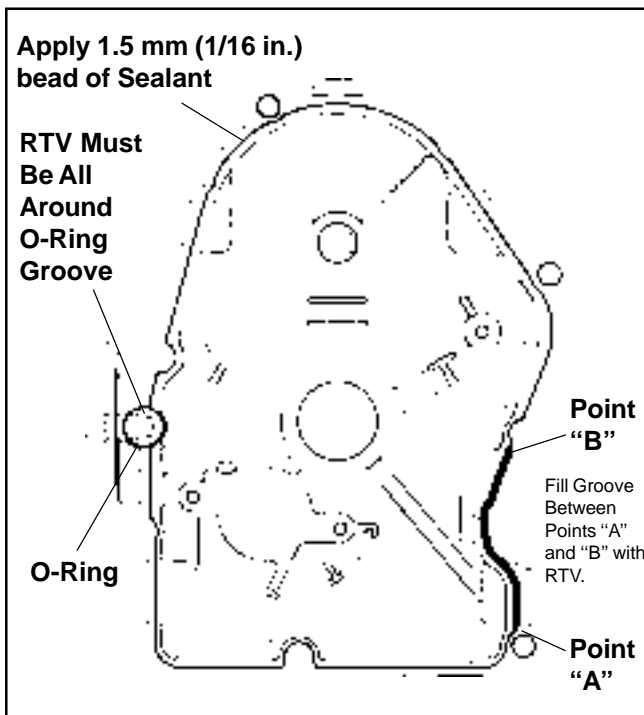


Figure 11-15. Oil Pan Sealant Pattern.

4. Make sure end of governor cross shaft is lying against the bottom of cylinder 2 inside the crankcase. See Figure 11-9.
5. Install oil pan to crankcase. Carefully seat the camshaft with shim and crankshaft into their mating bearings. Rotate the crankshaft to help engage oil pump and governor gear meshes.

6. Install the ten hex. flange screws securing the oil pan to the crankcase. Torque fasteners in the proper sequence to **24.4 N·m (216 in. lb.)**. See Figure 11-16 for the proper torque sequence. On some engines one of the ten mounting screws is plated. The plated screw should be installed in the #6 hole shown in Figure 11-16.

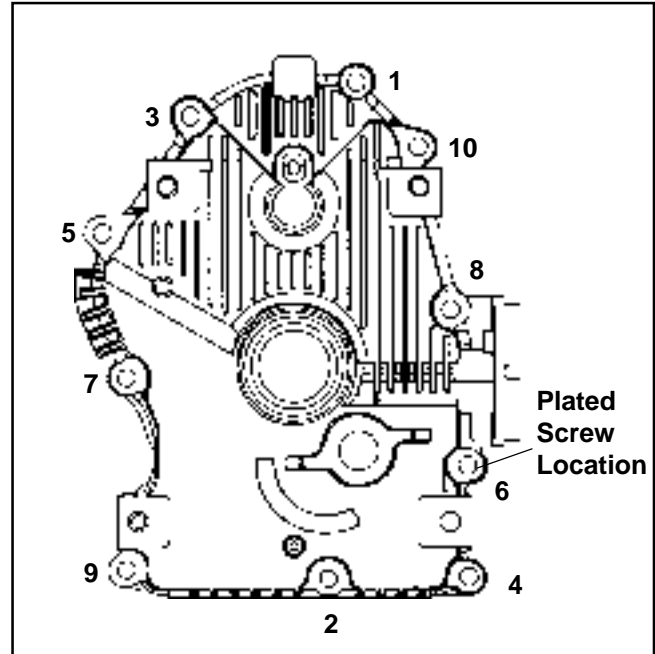


Figure 11-16. Oil Pan Torque Sequence.

### Install Cylinder Studs

NOTE: Do not reinstall or attempt to reuse any cylinder studs that have been removed. Discard any stud(s) removed. If any of the cylinder studs were removed from the crankcase, install **new** studs at this time as follows:

NOTE: Two different studs were used in production and **cannot** be interchanged or damage to the threads in the crankcase casting will occur. Use only the correct replacement stud(s). Refer to the parts manual for specific part number when ordering.

1. Identify the longer threaded end of new stud. See Figure 11-17. If Dri-Loc Loctite® is not visible, apply Loctite® No. 272 to 5-6 threads approximately 7 threads from the bottom. See Figure 11-17.

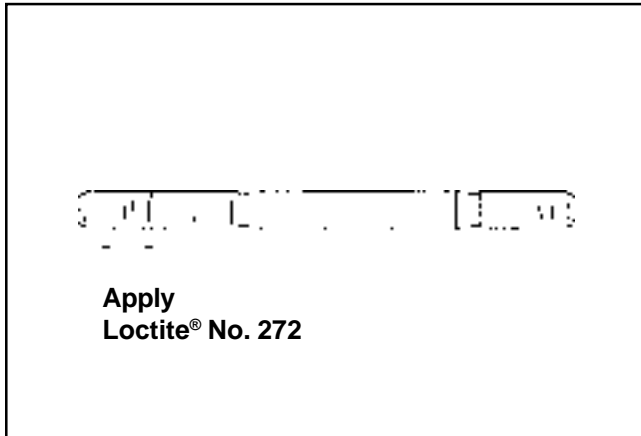


Figure 11-17. Applying Loctite to New Stud.

2. Tighten two nuts together on the shorter threaded section.
3. Thread the end of the stud with the Loctite® into the crankcase, until an exposed stud height of **75 mm (2.952 in.)** is obtained. The end with the dash mark must be out. See Figure 11-18. When threading in the studs, use a steady tightening motion without interruption until the proper height is obtained. The frictional heat from the engaging threads, may otherwise cause the locking compound to set up prematurely. Remove the two nuts.



Figure 11-18. Side View of Crankcase and Studs for Height Dimension/Reference.

4. Repeat Steps 1-3 for each of the studs.

### Install Hydraulic Lifters

1. Bleed the hydraulic lifters of internal oil so the plunger in the lifter can be depressed by hand. Use an old cutoff push rod mounted in a drill press, arbor press, or vice, and slowly apply pressure **two or three times** to bleed the lifters. See Figure 11-19. If a vice is used in bleeding the lifters, be sure to install protective coverings over the jaws to avoid damage to the base of the lifter(s).



Figure 11-19. Push Rod Tool.

NOTE: Another tool for bleeding may be made from an old tappet and ball bearing welded together. See Figure 11-20.



Figure 11-20. Tappet and Ball Bearing Welded Together.

2. Lightly lubricate the bottoms of the lifters with oil and install into their respective bores. **Do not prime the lifters.**

NOTE: Hydraulic lifters should always be installed in the same position as before disassembly.

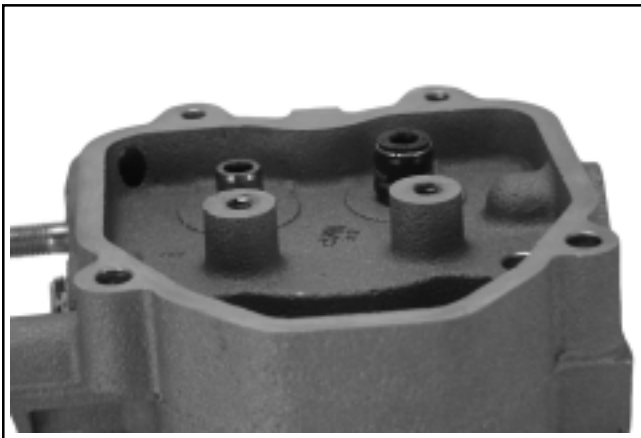
## Section 11 Reassembly

### Assemble Cylinder Heads

Prior to installation, lubricate all components with engine oil, paying particular attention to the lip of the valve stem seal, valve stems, and valve guides. Install the following items in the order listed below using a valve spring compressor. See Figures 11-21, 11-22, and 11-23.

- Valve stem seals (intake valve only)
- Intake and exhaust valves
- Valve spring caps
- Valve springs
- Valve spring retainers
- Valve spring keepers

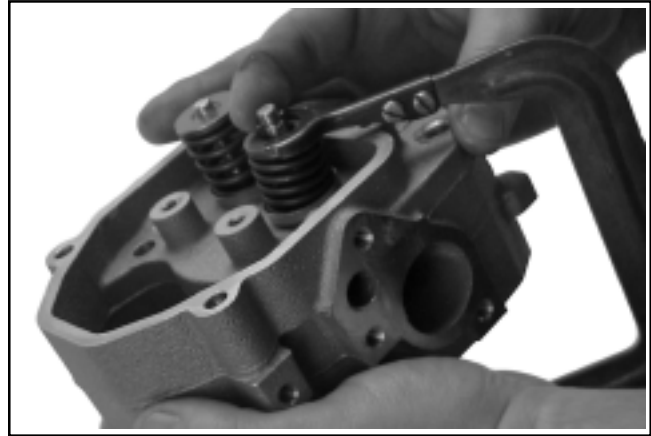
**NOTE:** These engines use valve stem seals on the intake valves. Always use a new seal when valves are installed in the cylinder head. Also, replace the seals if they are deteriorated or damaged in any way. Never reuse an old seal.



**Figure 11-21. Intake Seal.**



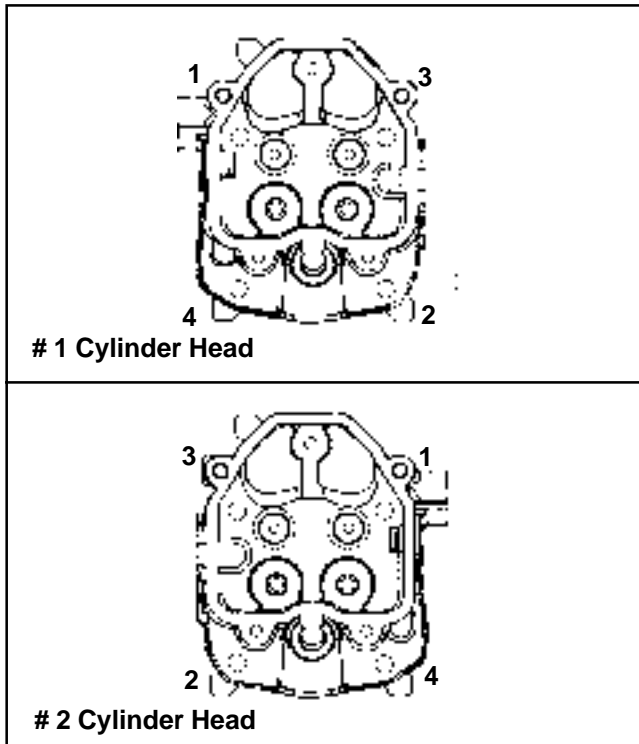
**Figure 11-22. Valve Components.**



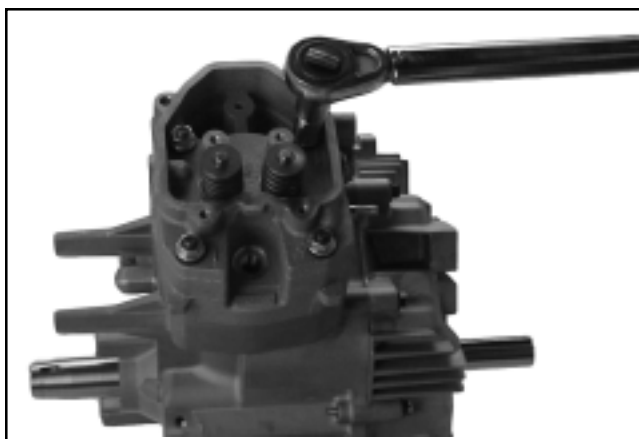
**Figure 11-23. Installing Valve with Spring Compressor.**

### Install Cylinder Heads

1. Check to make sure there are no nicks or burrs on the sealing surfaces of the cylinder heads or crankcase.
2. Install a new cylinder head gasket.  
  
**NOTE:** Match numbers embossed on cylinder heads and crankcase.
3. Install the #1 cylinder head onto the #1 side mounting studs. Do the same for the #2 head.
4. Install a plain washer onto each stud and secure with a hex. flange nut.
5. Initially torque the four hex. flange nuts in the proper sequence to **16.9 N·m (150 in. lb.)**. See Figure 11-24 for the correct torque sequence. Repeat the procedure, and torque the flange nuts to a final value of **33.9 N·m (300 in. lb.)**. See Figure 11-25.



**Figure 11-24. Cylinder Head Torque Sequence.**



**Figure 11-25. Torquing Cylinder Heads.**

6. Note the mark or tag identifying each push rod. Lightly apply assembly lubricant or grease to the ends of the push rods and install. Make sure that each push rod ball seats in its respective hydraulic lifter socket.

**NOTE:** Push rods must always be installed in the same position as before disassembly.

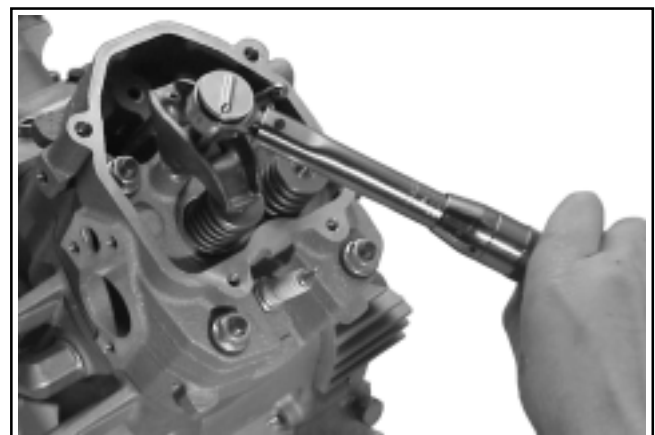
7. Rotate the crankshaft to align the keyway with the #1 cylinder. Rock the crankshaft and note whether the push rods/lifters on the #1 side are moving. If they are, rotate the crankshaft one full revolution. If the keyway is aligned with the cylinder, and rocking the crank produces no push rod/lifter movement, that cylinder is at TDC of the compression stroke.

### Valve Lash Setting Procedure Using a Dial Indicator

The preferred and recommended procedure for setting valve lash involves the use of a dial indicator. This is the most precise and accurate method, which should be utilized whenever possible. The lifters must be completely bled down (see “Install Hydraulic Lifters”) prior to performing this procedure. The Valve Lash Setting procedure not using a dial indicator starts on page 11.11.

8. Assemble the rocker arms and rocker arm pivots onto the #1 cylinder head. Position the rocker arm on the push rod and the end of the valve. Insert the hex. flange screw through the pivot, thread it onto the head, and torque it to **11.3 N·m (100 in. lb.)**. If the rocker arms are mounted with a stud and nut, instead of a hex. flange screw, torque the nut to **17.3 N·m (153 in. lb.)**. See Figure 11-26.

**NOTE:** Do not install any shims at this time.



**Figure 11-26. Torquing Rocker Arm.**



## Section 11 Reassembly

- Mount a dial indicator to touch the top of the valve retainer, of the valve to be set. See Figure 11-27.

NOTE: At this time, the valve will not be completely seated. **Do not rotate the crankshaft.**

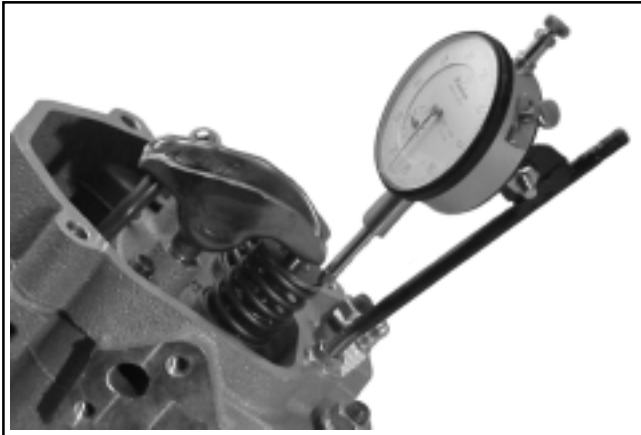


Figure 11-27. Mounted Dial Indicator.

- Rotate the face of the dial indicator to align the "0" with the needle. **Do not disturb the gauge position.** See Figure 11-28.



Figure 11-28. Align "0" with Needle.

- Carefully hold/prevent the rocker arm from turning and sliding off the end of the valve, but do not disturb the dial indicator setting. Slowly loosen the rocker arm mounting screw until the dial indicator needle movement stops. **Note and record this reading (from "zero") in thousandths.** See Figure 11-29. This was the distance the valve was being held open. The valve should now be completely closed.

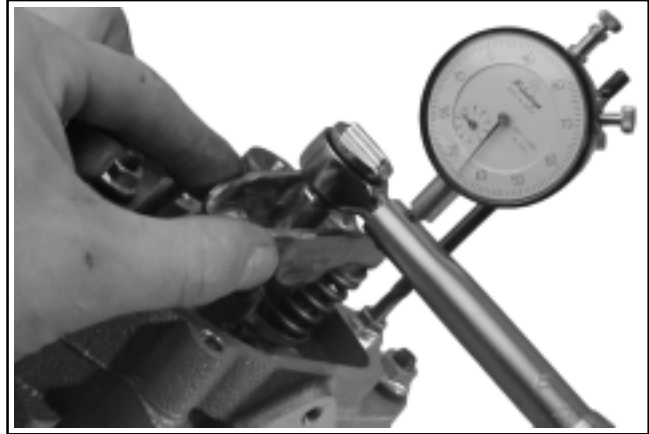


Figure 11-29. Back Off Screw Until Needle Stops.

- Using the reading from step 11, refer to the Shim Selection Chart below to determine what shim(s) will be required. If you need additional shims, beside those taken out during disassembly, refer to the parts manual and order the shim kit. The kit contains a sufficient assortment to cover all possible combinations on one engine.

### Available Shims & Identification:

.004 in. Shims contain a **Blue Line**  
 .008 in. Shims contain a **Red Dot**  
 .020 in. Shims contain a **Black Dot**

### Shim Selection Chart

Dial Indicator Reading	Required Shims		
	0.004 in.	0.008 in.	0.020 in.
0.000 in.-0.009 in.	1	-	-
0.010 in.-0.019 in.	-	1	-
0.020 in.-0.028 in.	1	1	-
0.029 in.-0.038 in.	-	2	-
0.039 in.-0.048 in.	-	-	1
0.049 in.-0.058 in.	1	-	1
0.059 in.-0.067 in.	-	1	1
0.068 in.-0.077 in.	1	1	1
0.078 in.-0.086 in.	-	2	1
0.087 in.-0.097 in.	-	-	2
0.098 in.-0.106 in.	1	-	2
0.107 in.-0.116 in.	-	1	2
0.117 in.-0.120 in.	1	1	2

- Remove the rocker arm assembly and place the required shim(s) on the screw/stud, below the pivot. Lightly lubricate all moving/contact surfaces with engine oil. See Figure 11-30.

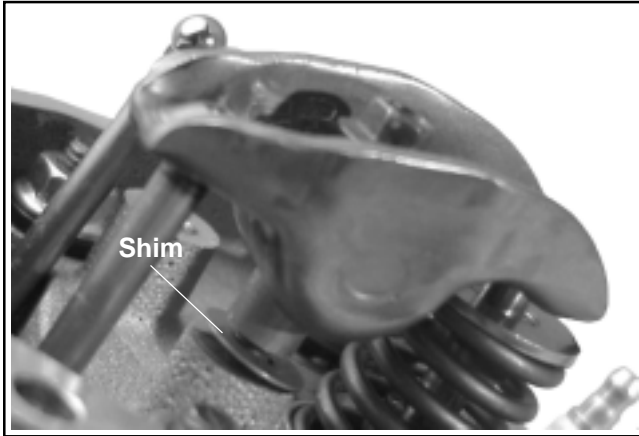


Figure 11-30. Installing Shim(s).

14. Reassemble the rocker arm and pivot assembly to the head and seat the push rod. See Figure 11-30. Torque the fastener; **11.3 N·m (100 in. lb.)** for a hex. flange screw, or **17.3 N·m (153 in. lb.)** for a lock nut. See Figure 11-31.
15. Hold down the push rod end of the rocker arm (step 9). Using a feeler gauge, check that there is **0.03-0.3 mm (0.001-0.010 in.)** clearance between the rocker arm and the end of the valve. See Figure 11-38.

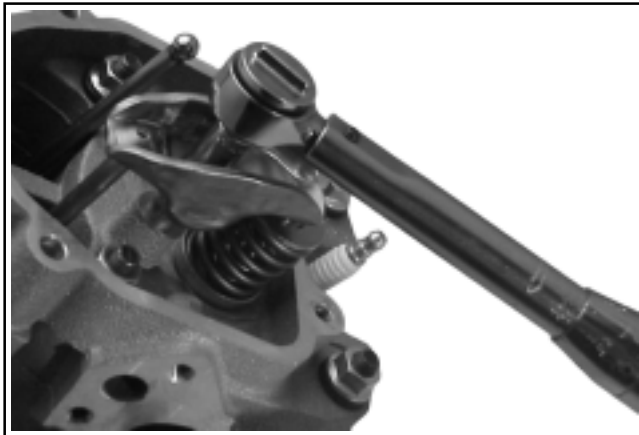


Figure 11-31. Torquing Rocker Arm.

16. Repeat the procedure for the other valve.
17. As viewed from the PTO end, rotate the crankshaft 3/4 turn (270°) counterclockwise and align the crankshaft keyway with the #2 cylinder, which now puts that cylinder at TDC on the compression stroke. Repeat steps 3-15 for the #2 head. **Do not** interchange parts from one cylinder head to the other.

### Valve Lash Setting Procedure Not Using a Dial Indicator

The following procedure may be used as an alternate method for setting the valve lash. Although not as precise as using the dial indicator method, a valve lash setting within 0.001 in. - 0.003 in. of the previous procedure is possible. It is imperative that the lifters be completely bled down (See “Install Hydraulic Lifters”) so they can be compressed by hand.

8. Assemble the rocker arms and rocker arm pivots onto the cylinder head. **Do not move or rotate the crankshaft.**

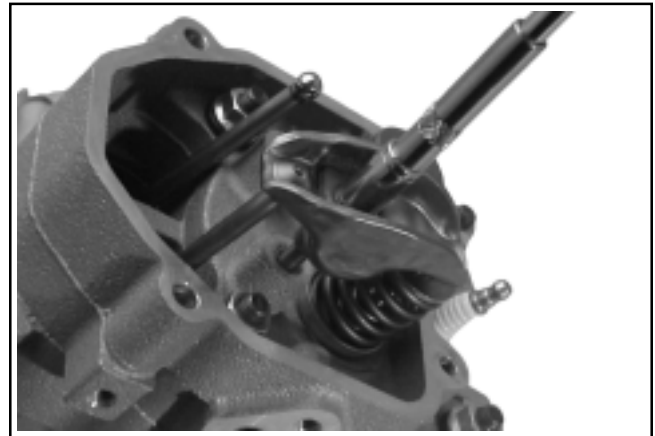


Figure 11-32. Mounting the Rocker Arm onto the Cylinder Head.

9. Manually depress the push rod end of the rocker arm to the bottom/limit of the lifter plunger travel. The opposite end of the rocker arm should be directly over the end of the valve. **Hold in this position for the next two steps (10, 11), do not release.** See Figure 11-33.

NOTE: If at any time during the setting procedure the lifter plunger cannot be depressed by hand or is very hard to move, STOP! Remove the lifter, re-bleed and reinstall.

## Section 11 Reassembly



Figure 11-33. Depressing To Bottom Limit of Lifter Plunger Travel.

10. **With the lifter still compressed**, slowly tighten the rocker arm fastener (clockwise) until the free end of the rocker arm just makes contact with the end of the valve. See Figure 11-34.

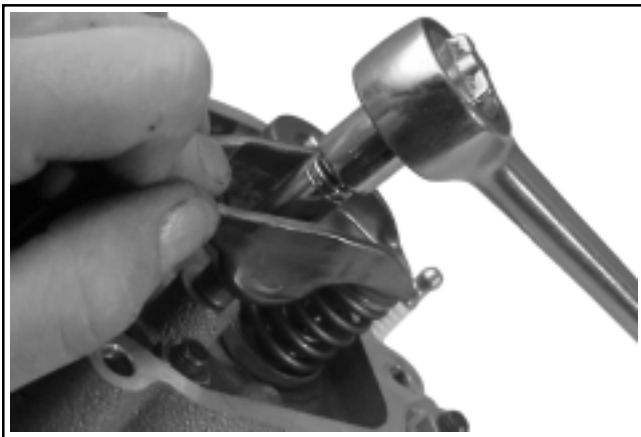


Figure 11-34. Establishing "0" Lash/ "0" Preload.

11. **While still maintaining pressure on rocker arm/lifter**, use a feeler gauge and determine the existing clearance between the base of the pivot and adjacent surface of the cylinder head. See Figure 11-35. Record this dimension.



Figure 11-35. Determining Clearance with Feeler Gauge.

12. Add 0.004" to the dimension from step 11 and record the total. This is the total shim thickness required for proper valve lash. Refer to the following table and determine which combination of shims will get you closest to that total. If you need additional shims, beside those taken out during disassembly, refer to the parts manual and order the shim kit. The kit contains a sufficient assortment to cover all possible combinations on one engine.

NOTE: Do not use the shim selection chart on page 11.10 when using this procedure.

### Available Shim Thickness & Identification:

.004 in. Shims contain a **Blue Line**  
.008 in. Shims contain a **Red Dot**  
.020 in. Shims contain a **Black Dot**

13. Remove the rocker arm assembly and place the selected shims on the screw/stud, below the pivot. Lightly lubricate all moving/contact surfaces with engine oil.
14. Reassemble the rocker arm and pivot assembly (with shims) to the head (see Figure 11-36) and seat the push rod. Torque the fastener; **11.3 N·m (100 in. lb.)** for a hex. flange screw, or **17.3 N·m (153 in. lb.)** for a lock nut. See Figure 11-37.

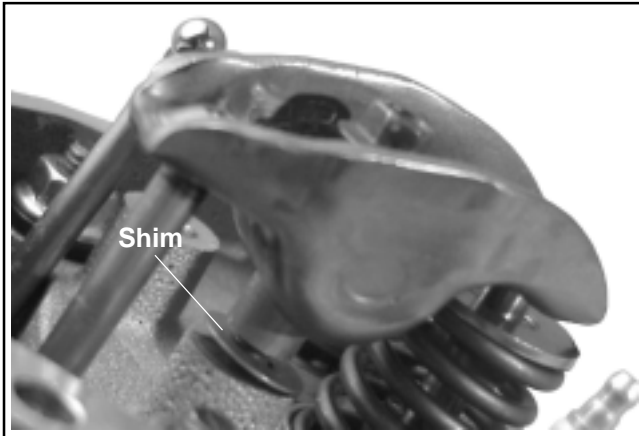


Figure 11-36. Installing Shim(s).

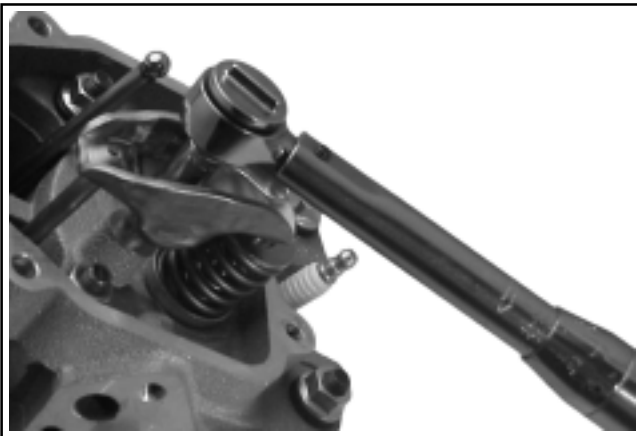


Figure 11-37. Torquing Rocker Arm.

15. Hold down the push rod end of the rocker arm (step 9). Using a feeler gauge, check that there is **0.03-0.3 mm (0.001 to 0.010 in.)** clearance between the rocker arm and the end of the valve. See Figure 11-38.

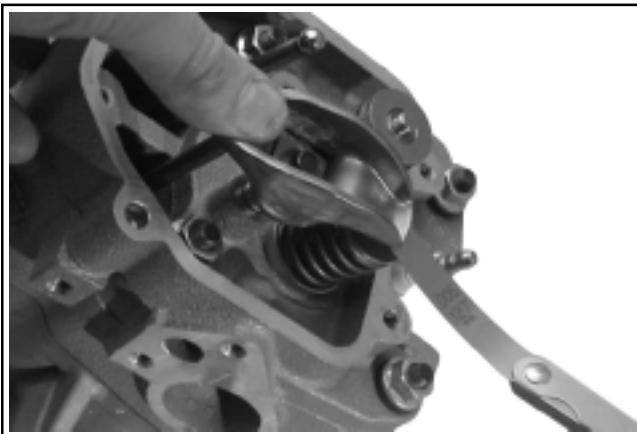


Figure 11-38. Checking for 0.001 in. - 0.010 in. Clearance.

16. Repeat the procedure for the other valve.
17. As viewed from the PTO end, rotate the crankshaft 3/4 turn (270°) counterclockwise and align the crankshaft keyway with the #2 cylinder, which now puts that cylinder at TDC on the compression stroke. Repeat steps 8-15 for the #2 head. **Do not** interchange parts from one cylinder head to the other.

### Reinstall Cylinder Drain Plugs

1. Reinstall the drain plugs into the cylinder heads if they were removed in the disassembly procedure. Apply pipe sealant with Teflon® (not Teflon® tape) to threads and reinstall the plugs. Torque the plugs to **13.6 N·m (120 in. lb.)**.

NOTE: Early production engines contained steel drain plugs. If encountered, replace with later production brass (soft) plugs, Kohler Part No. **66 139 01-S**.

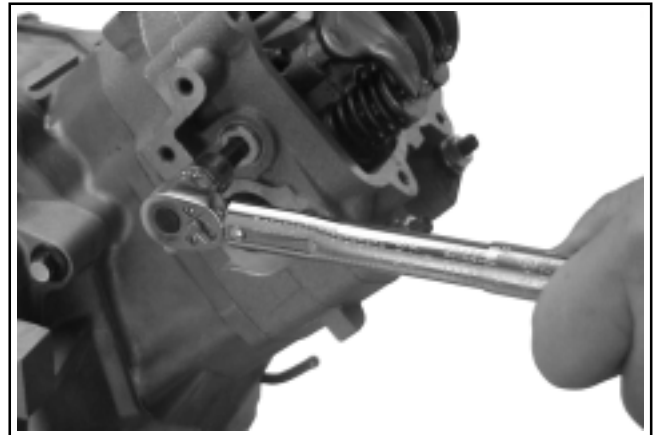


Figure 11-39. Torquing Drain Plug.

### Install Breather Cover and Gasket

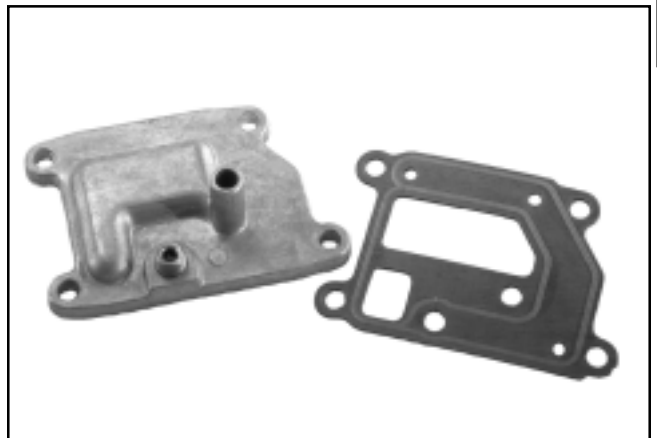
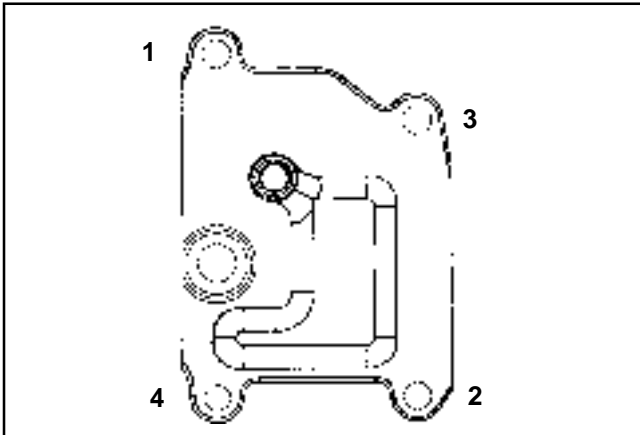


Figure 11-40. Breather Cover and Gasket.

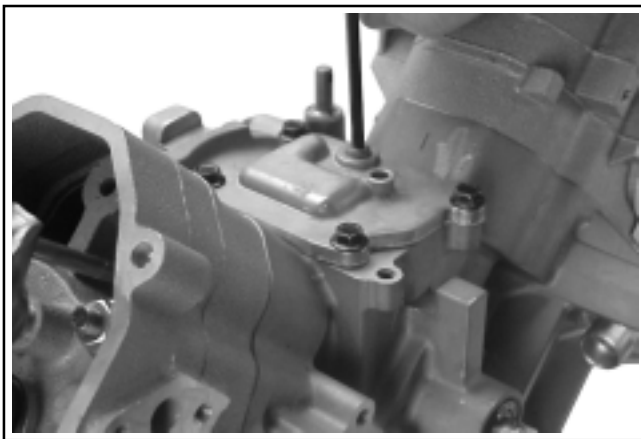
## Section 11 Reassembly

1. Make sure all sealing surfaces are clean and free of old gasket material.
2. Position a new breather cover gasket and the breather cover onto the crankcase. Install and finger tighten the four hex. flange mounting screws.
3. Torque the screws to **7.3 N·m (65 in. lb.)** in the sequence shown. See Figure 11-41.



**Figure 11-41. Breather Cover Fastener Torque Sequence.**

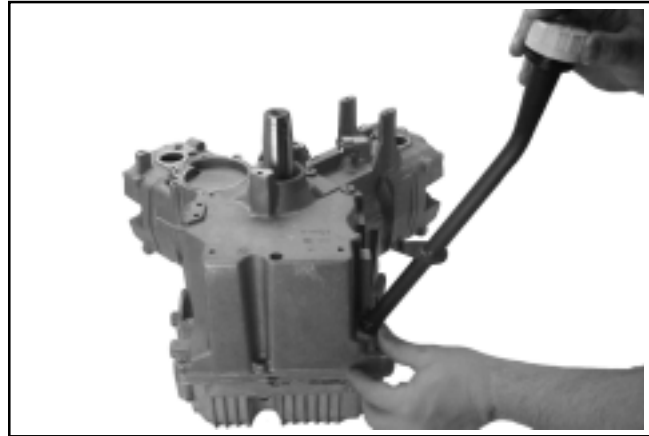
4. Apply pipe sealant with Teflon® (not Teflon® tape) to the threads of the 1/8" pipe plug or the Oil Sentry™ switch (if so equipped), and install into the breather cover. Torque to **4.5 N·m (40 in. lb.)**.



**Figure 11-42. Installing Pipe Plug.**

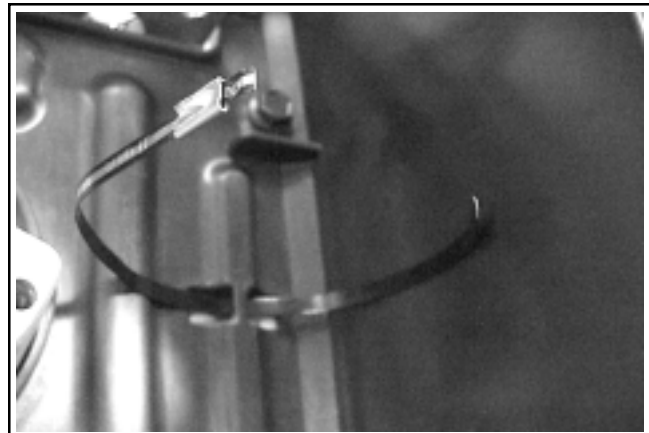
### Install Oil Fill/Dipstick Tube Assembly and Lower Blower Housing

1. Lubricate the O-Ring with engine oil, and install it on the lower end of the dipstick tube. Push the lower end of the tube assembly down into the crankcase until it seats into place. Orient the mounting tab so it faces towards the crankcase.



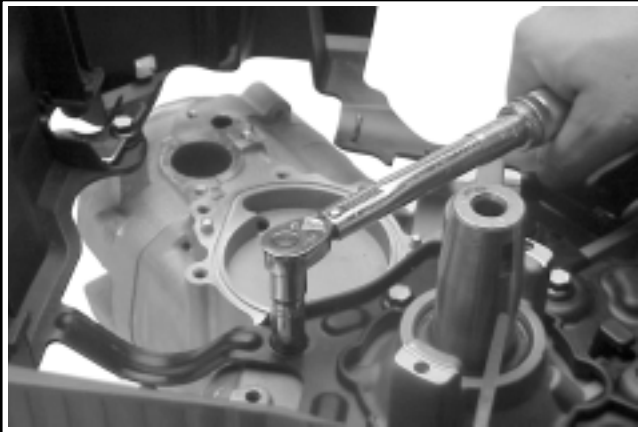
**Figure 11-43. Installing Dipstick Tube Assembly.**

2. Insert a new metal tie strap (Kohler Part No. 66 454 01-S) through the slotted opening in lower blower housing, as shown in Figure 11-44. This will restrain the lower hose/tube assembly. **Do not use plastic tie straps**, as adequate tension will not be maintained.



**Figure 11-44. Tie Strap in Lower Blower Housing.**

3. Set the lower blower housing down into position on the crankcase, and align the eight mounting screw locations. Insert the mounting tab of the oil fill/dipstick tube into the corresponding blower housing slot from the bottom.
4. Position the #2 side lifting bracket on top of the lower housing where it will be secured to the raised boss of the cylinder. Install the eight hex. head mounting screws. Torque the screws to **10.7 N·m (95 in. lb.)** if a first time/initial installation, or to **7.3 N·m (65 in. lb.)** anytime thereafter.



**Figure 11-45. Torquing Screws and Also Showing Lift Strap Mounted.**

5. Install safety interlock switch if removed from lower housing earlier.

### Install Intake Manifold

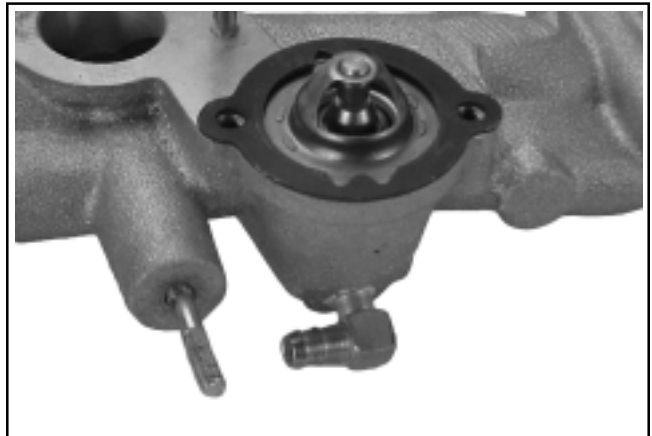
If the thermostat and thermostat housing were removed from the intake manifold, reassemble them at this time.

1. Make sure the sealing surfaces of housing and manifold are clean and free of nicks or damage.
2. Install the thermostat into the corresponding recess in opening of the intake manifold, so the larger spring end is down. Place a new thermostat housing gasket onto the manifold surface aligning the screw holes. **Do not use a substitute gasket.**

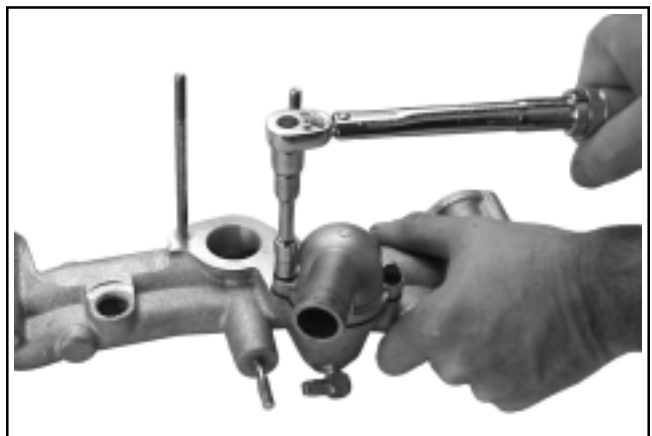


**Figure 11-46. Installing Thermostat in Manifold.**

3. Position the thermostat housing so the outlet faces away from the mounting surfaces of the intake manifold. The notch in manifold, gasket and thermostat housing must all be aligned. See Figure 11-47. Install and torque the two hex. flange screws to **9.9 N·m (88 in. lb.)**. See Figure 11-48.



**Figure 11-47. Gasket/Thermostat Notch Alignment.**



**Figure 11-48. Torquing Thermostat Housing Screws.**

4. Check that the gasket surfaces of the intake manifold and cylinder heads are clean and free of any nicks or damage.

## Section 11 Reassembly

5. Install new intake manifold gaskets onto the port surfaces of the cylinder heads. The use of gasket adhesive to prevent movement, will aid installation. Lower the intake manifold down and forward, into position on the gaskets and cylinder heads. Install and finger tighten the hex. flange screws in their appropriate locations to prevent the manifold from shifting, except for the two shorter length screws on the #1 side. These screws secure the wiring harness, the installation of which will follow, as well as the final torquing of the intake manifold.

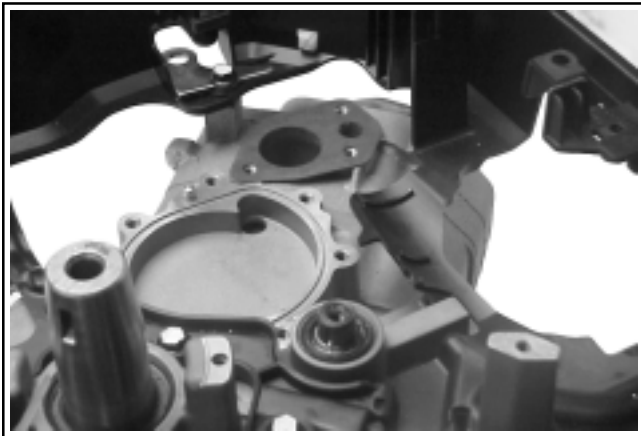


Figure 11-49. Intake Manifold Gasket in Place.

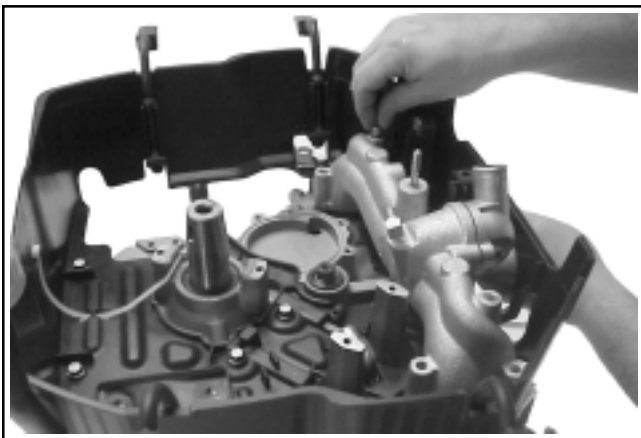


Figure 11-50. Intake Manifold in Place.

6. If the connector fitting for the by-pass hose was removed from the manifold previously, reinstall it at this time. Apply pipe sealant with Teflon® (not Teflon® tape) onto the threads and tighten so the fitting faces directly towards the long screw hole on the #2 side.

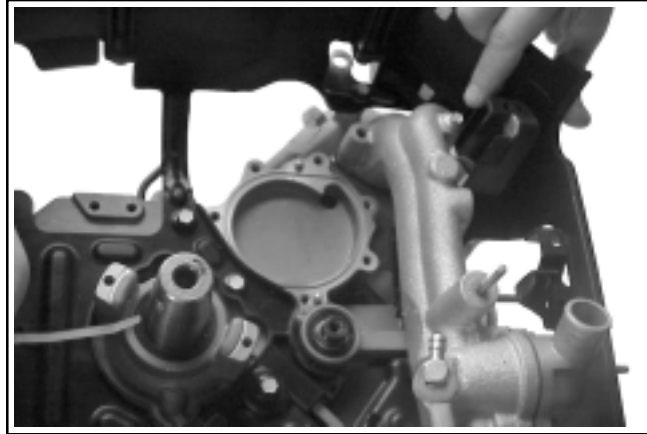


Figure 11-51. Connector Fitting Orientation with #2 Side Hole.

### Install Coolant By-pass Hose with Wiring Harness

1. Install the coolant by-pass hose, with the wiring harness attached, onto the fitting of the intake manifold. Secure with the hose clamp. Orient the tangs of the clamp so they face outward and slightly up, away from the flywheel.
2. Route the wiring harness as shown in Figure 11-52, and out through the openings in the blower housing. See Figure 11-53. Attach the clip encasing the wiring harness and the shorter ground lead to the #1 side, short screw location, closest to the crankshaft. Attach the remaining longer ground lead with the short screw furthest from the crankshaft. Orient the parts as shown in Figure 11-54 while tightening. Torque the six intake manifold mounting screws in two stages; initially to **7.4 N·m (66 in. lb.)** then to **9.9 N·m (88 in. lb.)** in the sequence shown in Figure 11-55.

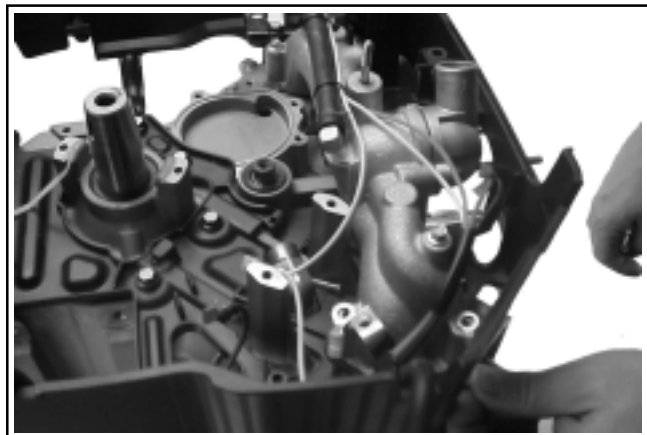


Figure 11-52. Wiring Harness (Top) Routing with Hose in Place on Fitting.



Figure 11-53. Wiring Harness out Through Openings in Lower Housing.

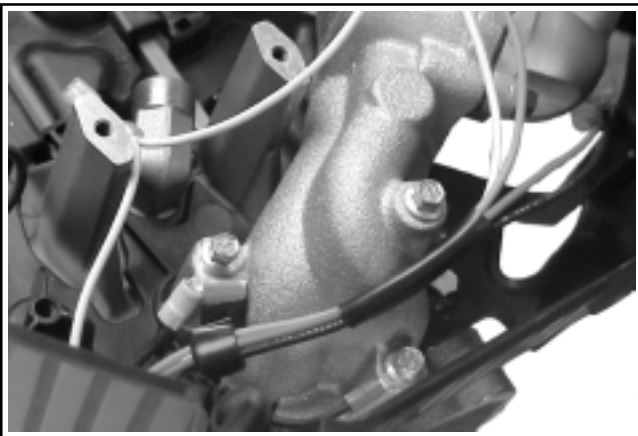


Figure 11-54. Ground Lead(s) Installation/Position.

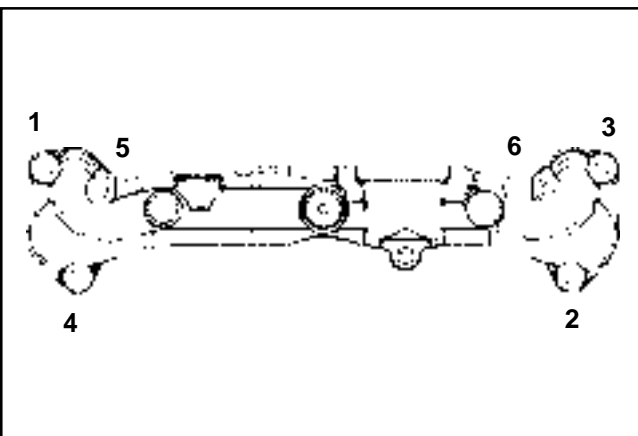


Figure 11-55. Intake Manifold Torque Sequence.

3. Install and tighten the pipe plug or temperature warning switch, if removed previously from the threaded port of the intake manifold. Use pipe sealant with Teflon® (not Teflon® tape) on the threads. Torque to **22.6 N-m (200 in. lb.)**. Connect the wire leads to the safety interlock switch and the temperature warning switch or audible alarm, as equipped.



Figure 11-56. Temperature Switch.

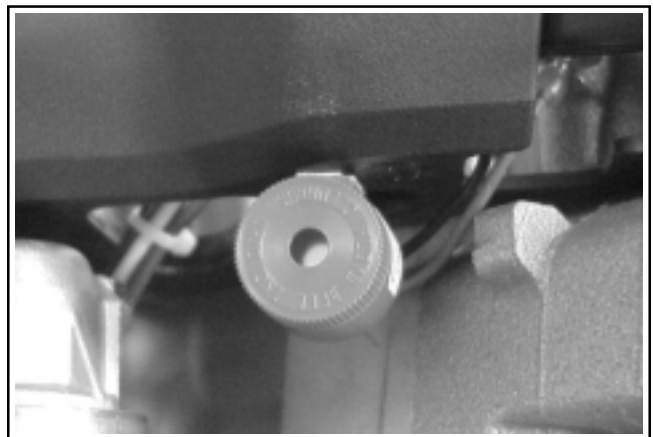


Figure 11-57. Audible Alarm.

### Install Water Pump, Drive Belt, and Transfer Tube Assembly

1. Remove the protective tape from over the keyway end of the camshaft. Make sure the keyway and the end of the camshaft are clean and free of any nicks or damage. Install and fully seat the key squarely into the keyway. Test fit the cam pulley onto the shaft and key; it must slide on **without force or restriction**. Remove the pulley.

NOTE: A mark or dot of paint applied to top of pulley indicating the keyway location will make installation easier.



## Section 11 Reassembly

2. If the fitting for the by-pass hose in the water pump was removed previously, apply pipe sealant with Teflon® (not Teflon® tape) on the threads and install onto the pump. Orient the fitting so the outlet points in the 10 o'clock position as shown in Figure 11-58.

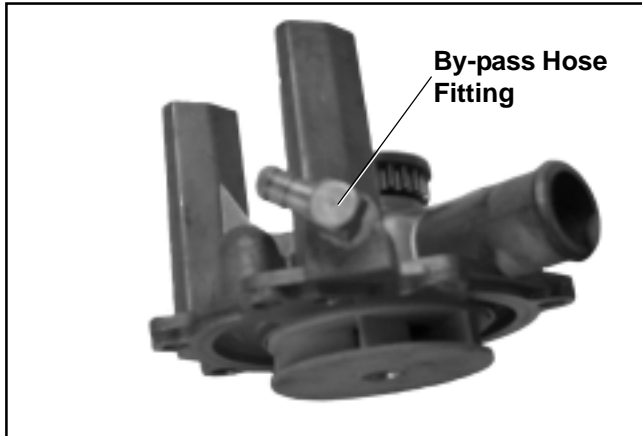


Figure 11-58. Fitting Position in Water Pump.

3. Check the sealing surfaces of the water pump and crankcase. They must be clean and free of any nicks or damage.
4. Place a new O-Ring in the groove of the crankcase, and apply a small amount of grease in several locations to hold it in place. See Figure 11-59. **DO NOT use RTV sealant in place of the O-Ring, or attempt to reinstall a used O-Ring.**

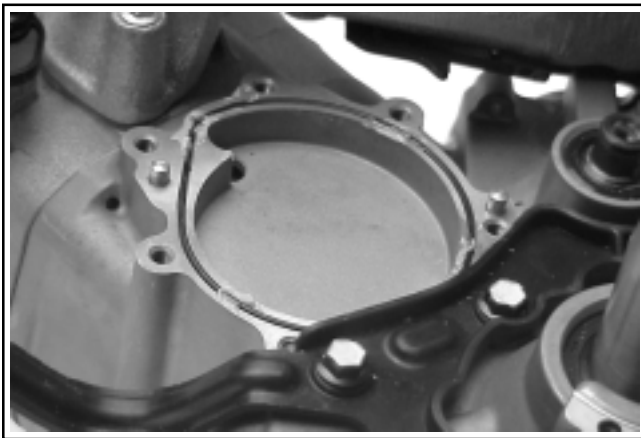


Figure 11-59. Installing O-Ring in Crankcase for Water Pump.

5. Apply rubber lubricant to the inner surface of the short hose section. Assemble the hose to the outlet of the water pump and secure with the larger diameter clamp. Orient the clamp so the tangs extend down in the 5 to 6 o'clock position, towards the impeller of the pump. See Figure 11-60.

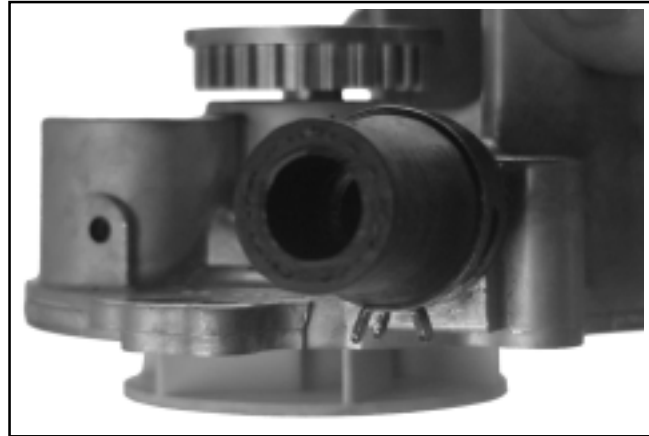


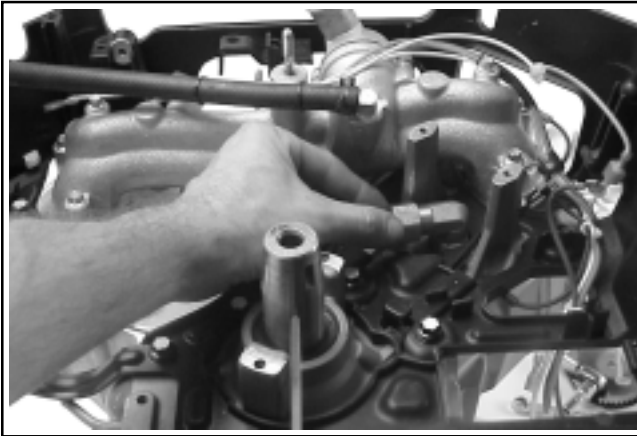
Figure 11-60. First Clamp and Hose Section Installation.

6. Slide the smaller diameter clamp onto the extruded end of the formed metal tube and insert this end of the tube into the hose section. Position the tube so its formed offset leads down and away from the outlet, perpendicular to the pump, as shown in Figure 11-61. Install the clamp onto the hose and position the tangs of the clamp parallel to those of the first clamp.



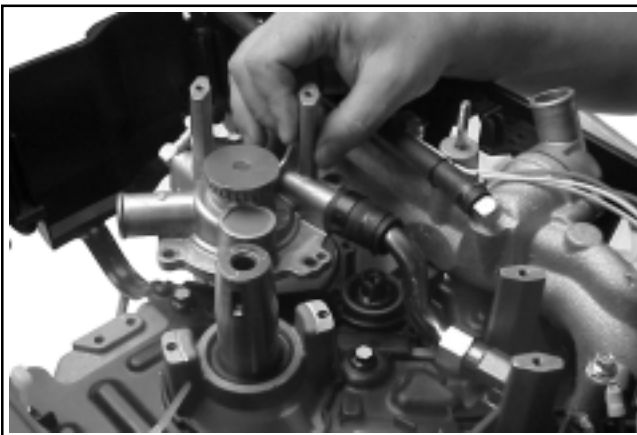
Figure 11-61. Tube and Second Clamp Installed.

7. Holding the water pump in a raised position, assemble the transfer tube to the 90° fitting in the crankcase as follows:
  - a. For new/first time tube installation, or if ferrule is loose on tube:
    - 1) Place a new ferrule/compression ring in the 90° fitting of crankcase and loosely install the hex. cap section onto the threads of the fitting. See Figure 11-62.



**Figure 11-62. Installing Ferrule and Hex. Cap onto Fitting.**

- 2) Insert the plain end of the transfer tube through the hex. cap and compression ring. See Figure 11-63.



**Figure 11-63. Inserting Tube into Ferrule and Hex. Cap.**

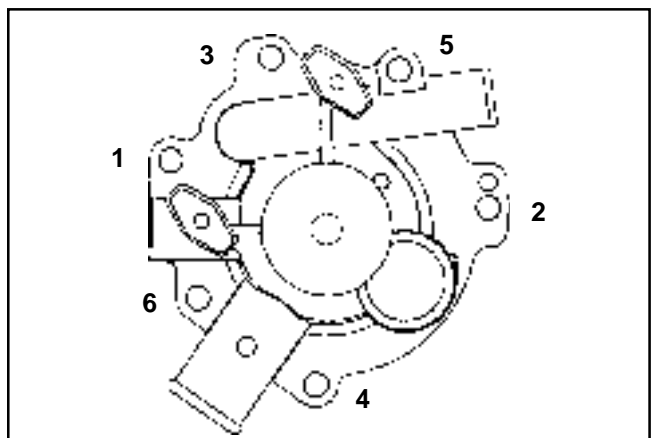
- b. For reinstallation of an existing tube or if ferrule is locked onto tube:
  - 1) Insert the end of transfer tube with the compression ring/ferrule into the 90° fitting of crankcase.
  - 2) Start and finger tighten the hex. cap onto the threaded section of the fitting.

**NOTE:** The 90° fitting in the crankcase to which the transfer tube is connected, is installed and sealed at the factory in a specific position. Special tools and procedures are involved. **DO NOT loosen, remove, or alter the mounting position of this fitting at any time.** Contact the Factory Service Department for specific instructions if the fitting is damaged, or its original mounting position is altered in any way.

8. Carefully push the water pump down from the raised position, rotating the tube 90° within the end connections. Guide the pump into position over the O-Ring; aligning the two mounting pins and five screw hole locations. See Figure 11-64. Start all of the screws, with the longer screw nearest the pump outlet. Torque the screws to **9.9 N·m (88 in. lb.)** in the sequence shown in Figure 11-65.



**Figure 11-64. Pushing Down on Pump and the Tube for Installation.**



**Figure 11-65. Water Pump Torque Sequence.**

## Section 11 Reassembly

NOTE: When installation is complete, the tangs of the two hose clamps must be down toward the crankcase, away from the flywheel and below the adjacent flange of the lower blower housing. See Figure 11-66.

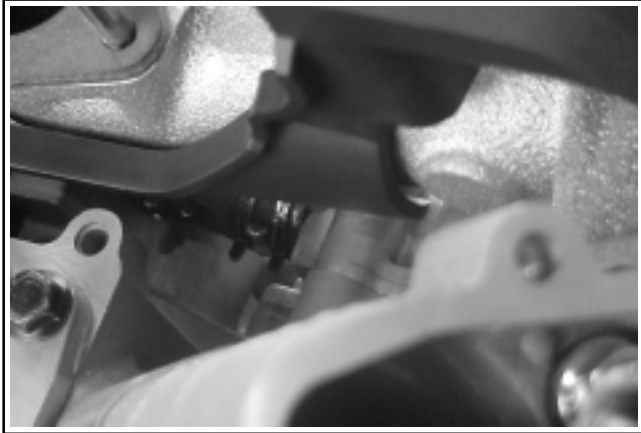


Figure 11-66. Tang Orientation of Clamps.

9. Push down on the formed tube and hold in this position to prevent it from pivoting upward when tightening the hex. cap. Torque the hex. cap portion of fitting to **22.6 N·m (200 in. lb.)**, to secure the joint connection and lock ferrule to tube. Support the fitting with a wrench while tightening the cap, to prevent applying unnecessary pressure on fitting and joint. See Figure 11-67. Check that the formed tube and hose section to pump have not been pulled up.

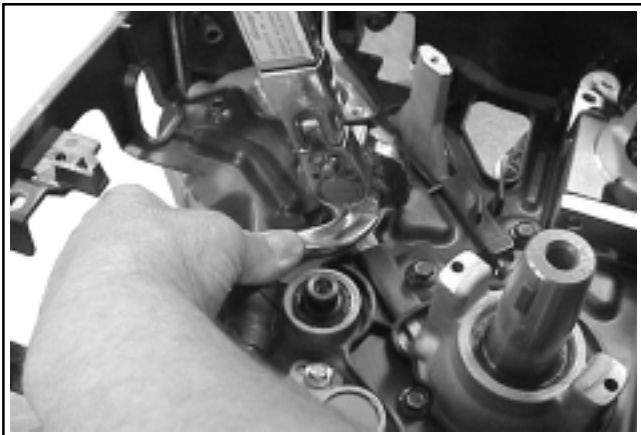


Figure 11-67. Torquing Cap Nut.

10. Install the drive belt onto the cogged pulley of the water pump, then around the cam pulley. Slide the cam pulley with the belt attached, down onto the keyway end of the camshaft. Be careful not to push the key out of the keyway, and/or into the seal, when installing the pulley.

NOTE: A mark or dab of paint applied to the top of pulley indicating the keyway location will aid installation.

11. Check that there is at least **3 mm (1/8 in.)** clearance between the underside of the pulley, and the hose, tube, clamp assembly. See Figure 11-68. Remove the pulley and reposition the tube or clamps if required. Install the flat washer and hex. flange screw to secure the pulley in place. Torque the screw to **9.9 N·m (88 in. lb.)**. See Figure 11-69.

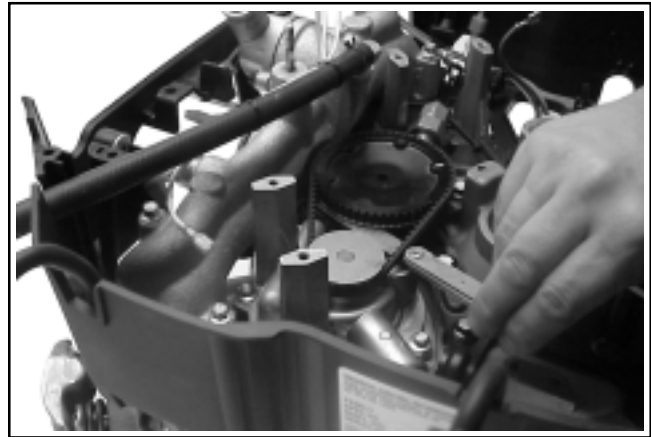


Figure 11-68. Checking Clearance of Pulley with Feeler Gauge.

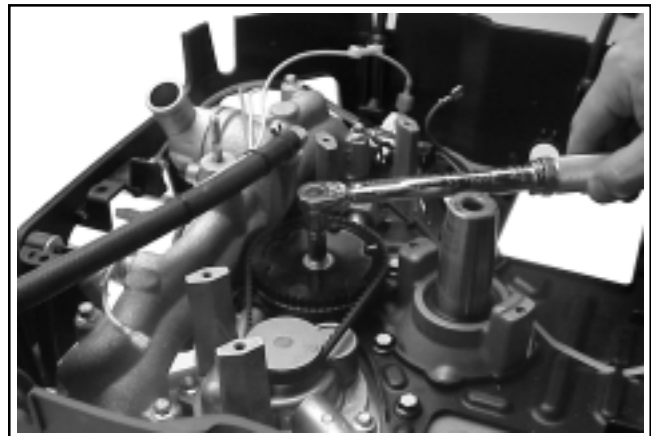


Figure 11-69. Torquing Mounting Screw of Cam Pulley.

12. Attach the by-pass hose to the fitting on the water pump and secure with the hose clamp. The tangs of the clamp should point outward. Completed installation should look as shown in Figure 11-70.

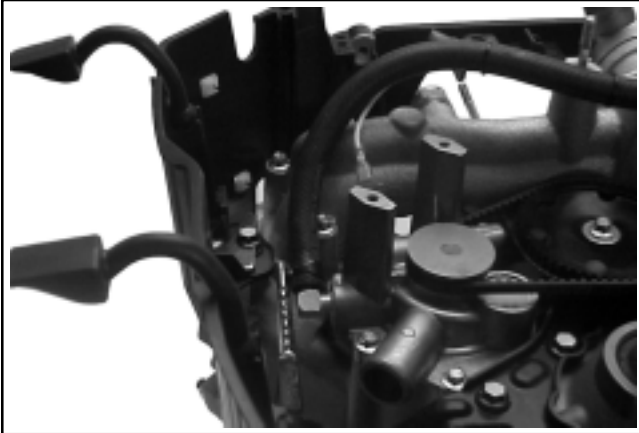


Figure 11-70. By-pass Hose Installation.

### Install Stator and Rectifier-Regulator

1. Position the stator onto the mounting bosses so the leads are at the bottom, and directed out toward the rectifier-regulator mount on the #1 side. Apply pipe sealant with Teflon<sup>®</sup> (not Teflon<sup>®</sup> tape) to the threads of the two stator mounting screws. Align the mounting holes and install the two hex. flange screws. Torque each screw to **6.2 N·m (55 in. lb.)**. See Figure 11-71.

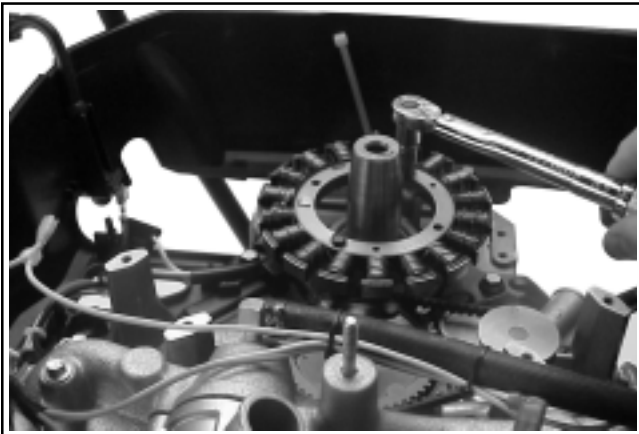


Figure 11-71. Torquing Stator Mounting Screw.

2. Check the terminal on the end of the violet B+ charging lead to be sure the locking tang is angled upward. Insert the terminal into the center location of the connector until it locks into place. Attach the connector assembly onto the terminals of the rectifier-regulator.

3. Position the rectifier-regulator onto the locating stud with its cooling fins “up”. Attach the ground lead to the mounting screw, install and torque the screw to **4.0 N·m (35 in. lb.)**.
4. Position the stator leads under the retaining tab, and down within the “channel” formed by the two raised ribs in the blower housing. See Figure 11-72.



Figure 11-72. Installed Rectifier-Regulator and Wire Routing.

### Install Radiators, Cooling System and Hoses

1. Install the hose clamps on the remaining hoses, inward from their respective mounting locations, but where the tangs will be accessible for final placement after the hose is in position.
2. Make sure new metal tie strap is still in position in the lower blower housing. See Figure 11-73.



Figure 11-73. Wire Tie Strap.

## Section 11

### Reassembly

- Place the small sleeve spacer onto the stud, in the center of the intake manifold. If the stud was removed from the manifold, apply Loctite® No. 290 to the lower set of threads and install until stud bottoms, or an exposed height of **32 mm (1.26 in.)** is obtained.
- Apply rubber lubricant to the inner surfaces of the disconnected hoses and mating surfaces on the thermostat housing and water pump.
- Set the radiators and cooling system, with the hoses attached, down into its general position. Connect the hoses to the inlet of the water pump, and the outlet of the thermostat housing. Secure each connection with the respective hose clamp. The tangs must be positioned outward. See Figure 11-74.

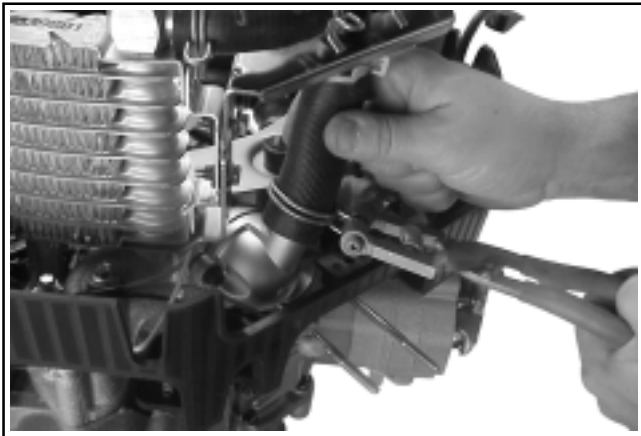


Figure 11-74. Installing Clamp on Thermostat.

- Position the rubber mount assembly over the stud with spacer on the intake manifold. Apply rubber lubricant to top of mount and install the flat washer and hex. flange nut. Torque the nut to **9.9 N·m (88 in. lb.)**. See Figure 11-75.

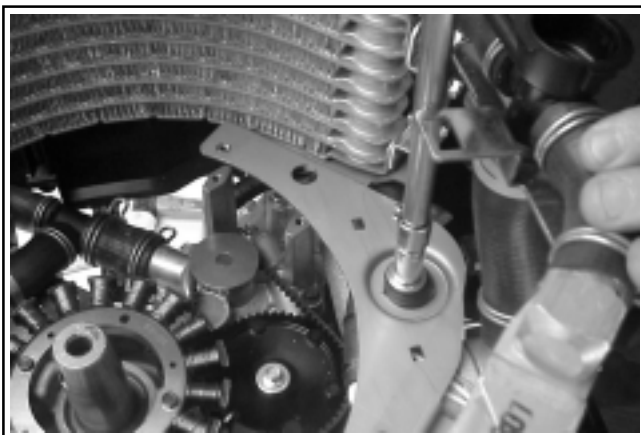


Figure 11-75. Torquing Center Nut.

- Align the rear mounting bracket with the corresponding set of holes in the crankcase. Position the half clamp over the hose and install the two hex. flange screws. See Figure 11-76. Allow the entire cooling system assembly to center itself within the constraints of the mounts, then torque the screws to **10.7 N·m (95 in. lb.)** if a first time/initial installation, or to **7.3 N·m (65 in. lb.)** anytime thereafter. Close, but do not tighten the metal tie strap around lower tube. See Figure 11-77. Tightening of tie strap assembly has been installed in the following sequence.

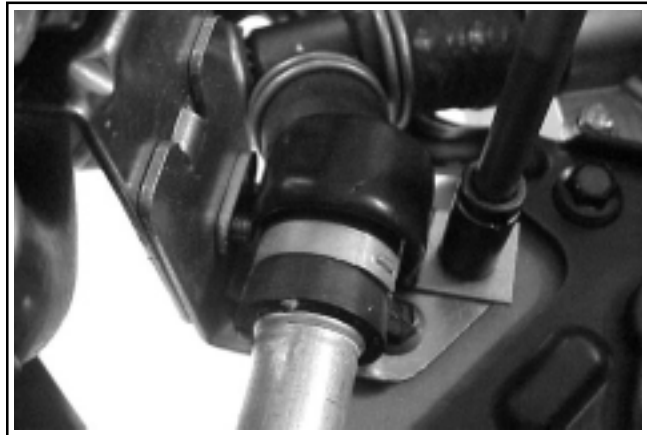


Figure 11-76. Rear Bracket/Clamp.

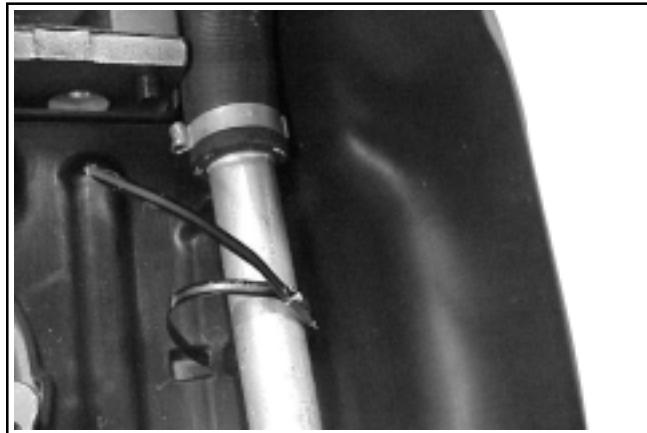


Figure 11-77. Tie Strap.

8. Lift the by-pass hose and secure it within the metal clip under the main support bracket. See Figure 11-78.

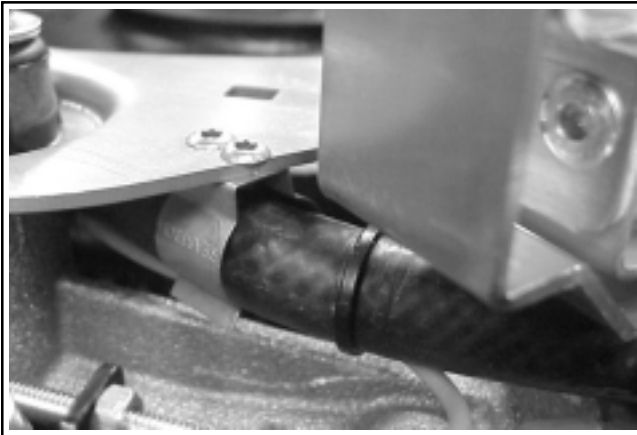


Figure 11-78. Seating By-pass Hose.

### Install Electric Starter

1. Position the starter mounting plate onto the crankcase so that the cutout is at the bottom, and the offset is toward the dipstick tube. Install and torque the two hex. flange mounting screws to **15.3 N·m (135 in. lb.)**. See Figure 11-79.

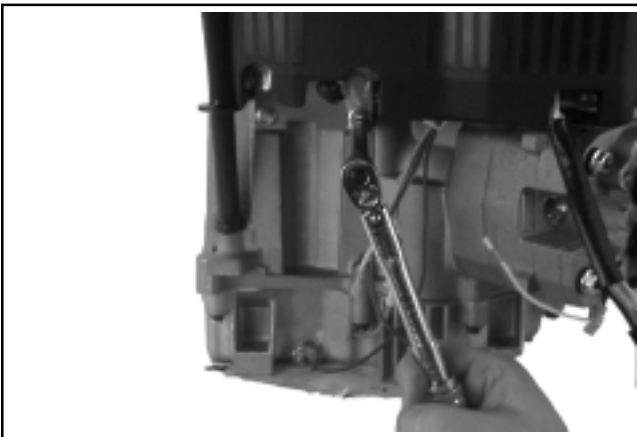


Figure 11-79. Torquing Adapter Plate Screws.

2. Mount the electric starter to the plate and **start** the two mounting bolts into the crankcase. The lifting bracket must be on the bolt closest to the solenoid, and should extend down and out.

3. Slide the adjacent radiator support bracket under the heads of the starter bolts and **behind** the lifting bracket. Check that the starter is square to the crankcase, then torque the mounting bolts to **15.3 N·m (135 in. lb.)**. See Figure 11-80.

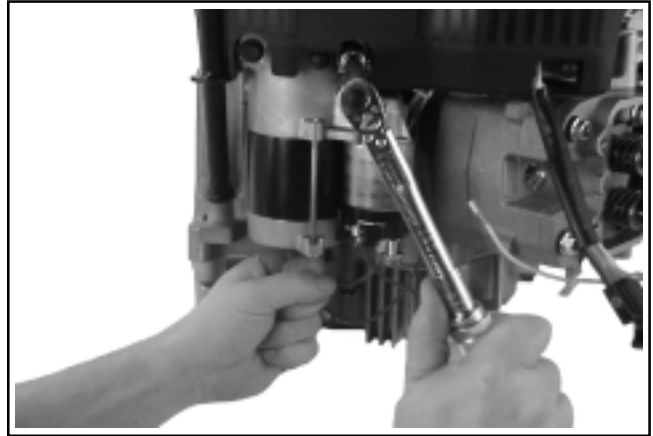


Figure 11-80. Torquing Starter Mounting Bolts.

4. Attach the leads to the solenoid and starter.
5. Push down on the lower tube/hose assembly and **securely tighten** the metal tie strap around the lower tube/hose assembly using a pliers. Make sure the head of tie strap is below the top of the tube where it will not be contacted by the flywheel. Cut off all excess strap material. See Figure 11-81.

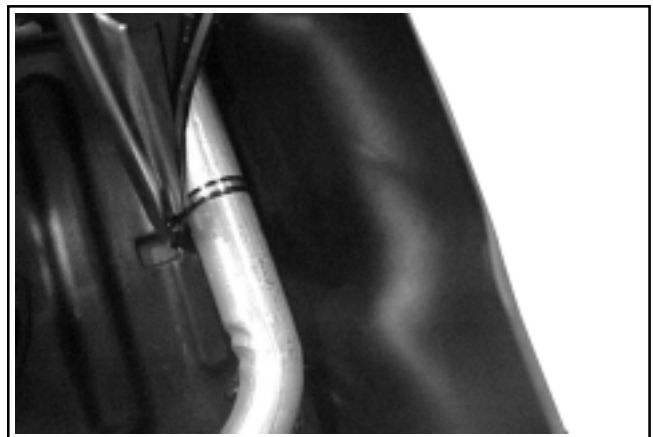


Figure 11-81. Tightening Tie Strap with Pliers.

## Section 11 Reassembly

### Install Ignition Modules and Flywheel

1. Route the spark plug leads of the ignition modules, out through the corresponding cutouts in the lower blower housing assembly.
2. Route the white kill leads from the wiring harness and connect them to the “kill” tabs of the ignition modules. See Figures 11-82 and 11-83.

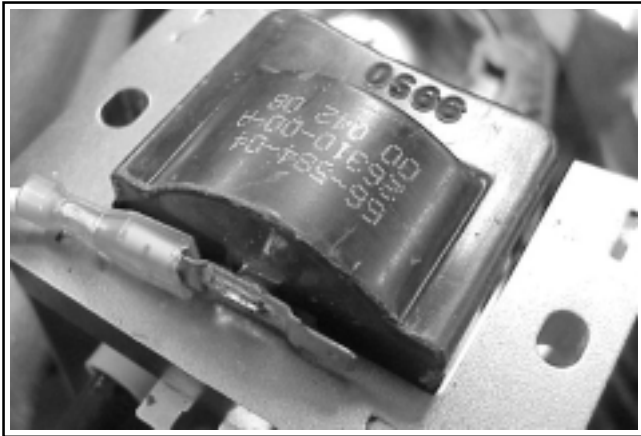


Figure 11-82. Ignition Module Kill Lead Mounting #2 Side.

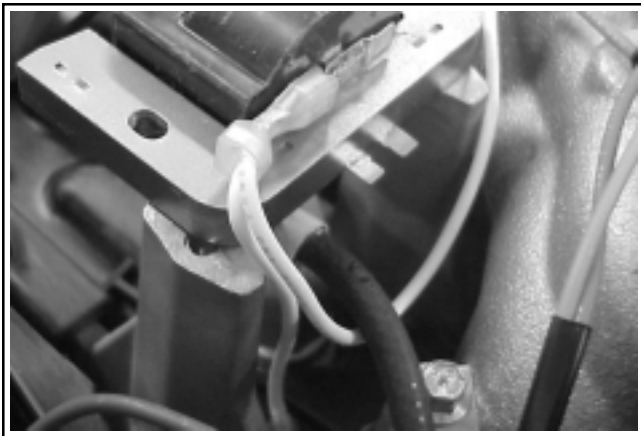


Figure 11-83. Ignition Module Kill Lead Mounting #1 Side.

3. Position the modules on top of the mounting bosses. Slide the ignition modules as far away from the crankshaft as possible. See Figure 11-84. Do not attempt to attach the modules onto the mounting bosses at this time.

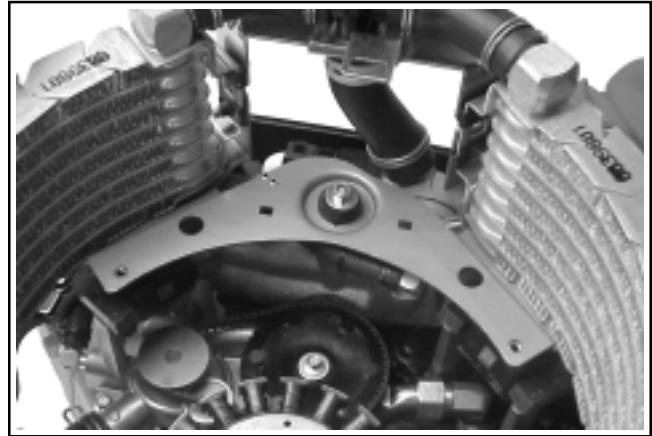


Figure 11-84. Ignition Modules “Back” as Far as Possible.

### Install the Flywheel



#### **Warning: Damaging Crankshaft and Flywheel Can Cause Personal Injury!**

*Using improper procedures to install the Flywheel can crack or damage the crankshaft and/or flywheel. This not only causes extensive engine damage, but can also cause personal injury, since broken fragments could be thrown from the engine. Always observe and use the following precautions and procedures when installing the flywheel.*

**NOTE:** Before installing the flywheel make sure the crankshaft taper and flywheel hub are clean, dry, and completely free of lubricants. The presence of lubricants can cause the flywheel to be overstressed and damaged when the hex. flange screw is torqued to specifications.

**NOTE:** Always use a flywheel strap wrench or holding tool to hold the flywheel when tightening the flywheel fastener. Do not use any type of bar or wedge to hold the flywheel, as component damage and personal injury could result.

1. Install the woodruff key into the keyway of the crankshaft. Make sure that the key is properly seated and parallel with the shaft.

**NOTE:** Make sure the flywheel key is installed properly in the keyway. The flywheel can become cracked or damaged if the key is improperly installed.

2. Thread two or three long bolts into the hub of the flywheel, or use the flywheel puller, to serve as a “handle” for setting the flywheel in place.

3. Lower the flywheel down into position on crankshaft and make sure the ring gear section is below the legs of the ignition modules. See Figure 11-85.



Figure 11-85. Lowering the Flywheel into Position.

4. Install the hex. flange screw and washer.
5. Use a flywheel holding tool to hold the flywheel and torque the screw to **66.4 N·m (49 ft. lb.)**. See Figure 11-86.

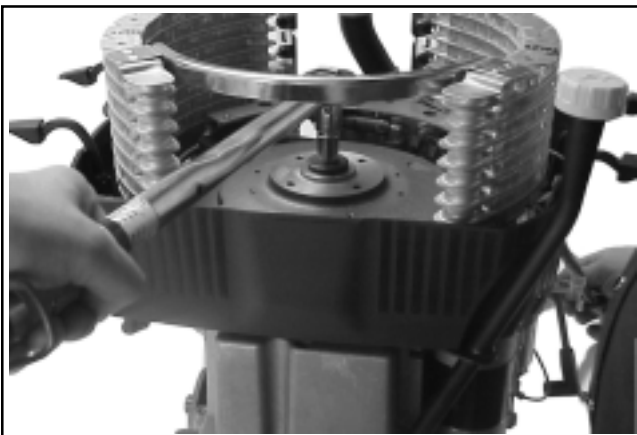


Figure 11-86. Torquing of the Flywheel Mounting Screw and Washer.

6. Using a light, visually check through the cutout opening in lower blower housing on the #2 side, that **3 mm (1/8")** clearance exists between the top of the lower hose/tube assembly and bottom of the flywheel, especially where the hose "turns up" and connects to the #1 side radiator.

If clearance is OK, continue with installation of the ignition modules. If clearance is insufficient or contact is noted; remove the flywheel and recheck the tension of the tie strap, the position of the lower hose and tube assembly, and the mounting of the cooling system. Readjust as required, remount the flywheel, and recheck for adequate clearance.

### Install the Ignition Modules

1. Rotate the flywheel to position the magnet away from the ignition modules. Two screws or the flywheel puller reinstalled onto the flywheel, makes rotation easy.
2. Install the ignition modules using the four hex. flange screws. Two of the mounting screws are accessed through holes in the main radiator support bracket. Slide the ignition modules away from the flywheel as far as possible, and tighten the four screws.
3. Rotate the flywheel to position the magnet directly under one of the ignition modules.
4. Insert a **0.36 mm (0.014 in.)** flat feeler gauge between the magnet and ignition module. See Figure 11-87. Loosen the hex. flange screws enough to allow the magnet to pull the module against the feeler gauge.

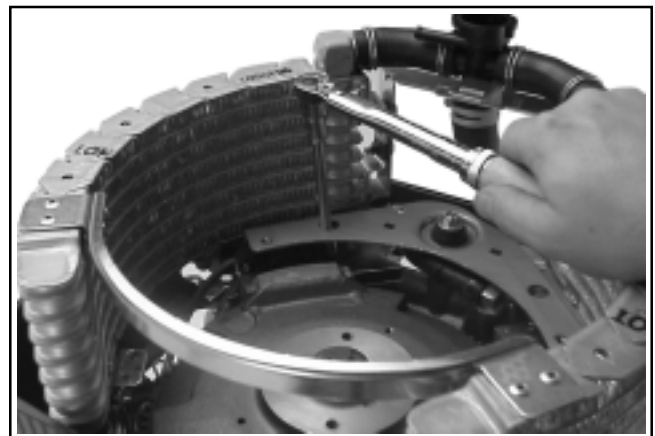


Figure 11-87. Setting Ignition Module Air Gap.

5. Torque the two hex. flange screws to **4.0 N·m (35 in. lb.)**.
6. Repeat steps 3 through 5 for the other ignition module.



## Section 11

### Reassembly

7. Rotate the flywheel back and forth checking for clearance between the magnet and ignition modules. Make sure the magnet does not strike the modules. Recheck the gap with a feeler gauge and readjust if necessary. Final Air Gap: **0.28/0.33 mm (0.011/0.013 in.)**.

#### Install Spark Plugs

1. Install the spark plugs into the cylinder heads and torque each to **24.4/29.8 N·m (18/22 ft. lb.)**. See Figure 11-88.

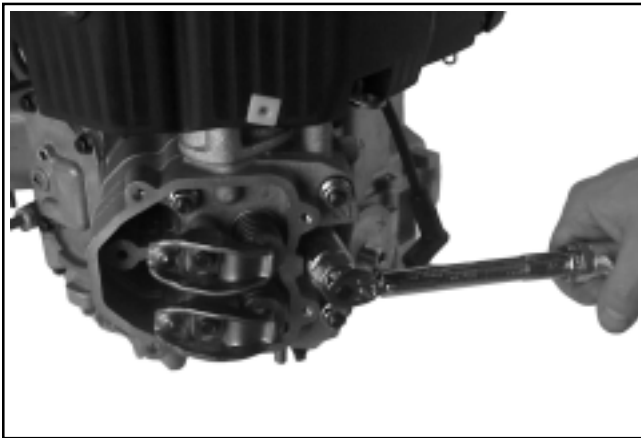


Figure 11-88. Torquing Spark Plugs.

#### Install Overflow Reservoir

1. Insert the two molded protrusions on the bottom of the overflow reservoir into the corresponding holes in the main bracket.
2. Lightly lift the top bracket and tilt the reservoir into place.
3. Torque the upper two mounting bracket screws to **5.5 N·m (49 in. lb.)**. See Figure 11-89.
4. Install the reservoir cap and hose. Make sure the hose is not kinked or pinched.

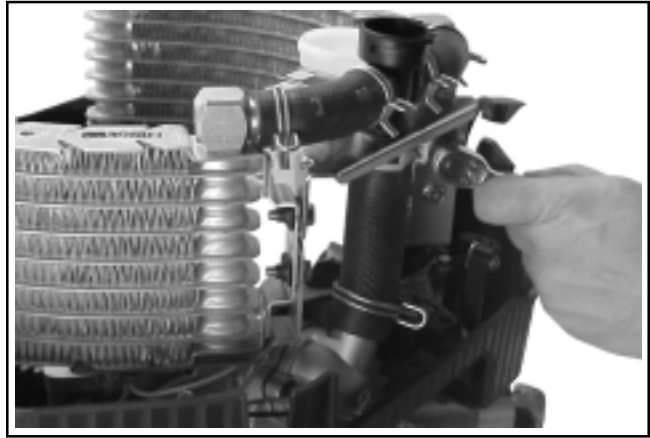


Figure 11-89. Tightening Upper Mounting Screws with Reservoir Installed.

#### Install Blocking Plates and Fan

1. Install the #1 and #2 blocking plates into the radiator supports as shown in Figure 11-90. If two different types of screws were used, install the two screws with the flanges in the locations **closest** to the intake manifold. Torque all screws to **3.9 N·m (35 in. lb.)**.

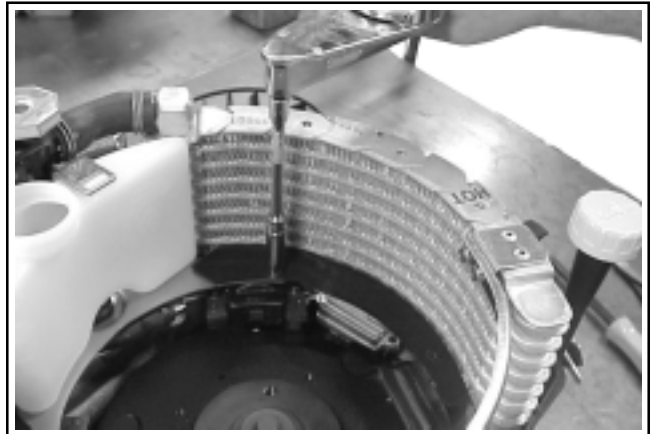


Figure 11-90. Installing Baffle Screws.

2. Position the fan on the flywheel. Align the cutout section over the corresponding magnet section, and engage the two locating studs into the corresponding holes in the flywheel.
3. Install and torque the four fan mounting screws to **9.9 N·m (88 in. lb.)**.
4. Rotate the flywheel and fan and recheck that adequate clearance exists to all surrounding parts.

### Checking Valve Train

1. Rotate engine to check for free operation of the valve train. Check the clearance between valve spring coils at full lift. Minimum allowable clearance is 0.25 mm (0.01 in.). If engine seems tight or spring coils do not have proper clearance, repeat the valve lash adjustment procedure.

### Install Valve Covers

1. Make sure the sealing surfaces of cylinder heads and valve covers are clean and free of all old gasket material.
2. Position new gaskets on the gasket surfaces of the valve covers and press them onto the molded locating pins.
3. Install the valve cover with the breather assembly on the #1 side, and finger tighten the four mounting screws. Make sure the gasket stays aligned. See Figure 11-91.



Figure 11-91. #1 Side Valve Cover.

4. Install the other cover on the #2 side in the same manner.
5. Torque the mounting screws of each cover in the sequence shown to **6.2 N-m (55 in. lb.)**. Do not overtighten. See Figure 11-92.
6. Route the breather tube through the opening in the lower blower housing, if it was removed from the breather fitting in the valve cover. Connect the tube to the outlet of the breather and secure with the clamp.

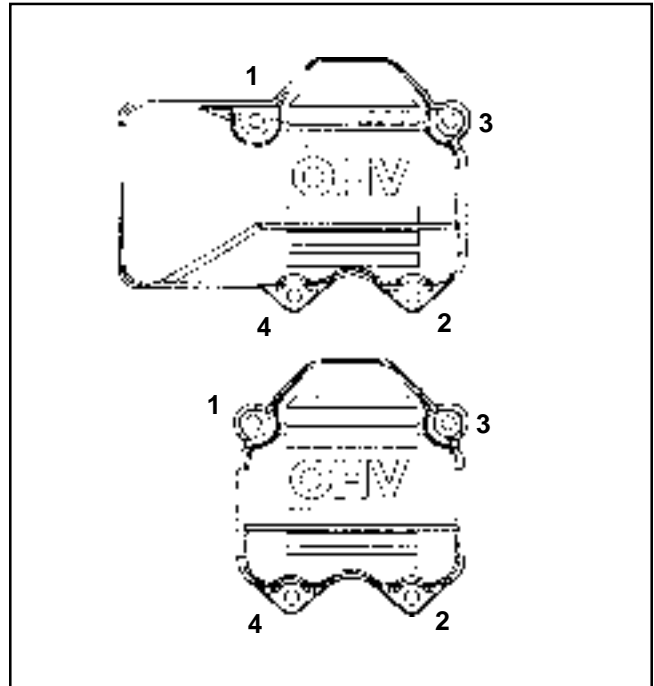


Figure 11-92. Valve Cover Torque Sequence.

### Install Carburetor



#### WARNING: Explosive Fuel!

Gasoline may be present in the carburetor and fuel system. Gasoline is extremely flammable and its vapors can explode if ignited. Keep sparks and other sources of ignition away from the engine.

1. Install the carburetor gasket. Make sure all holes are aligned and open.
2. Attach the choke linkage and the throttle linkage with dampening spring into their lever hole locations on the carburetor. See Figure 11-93.

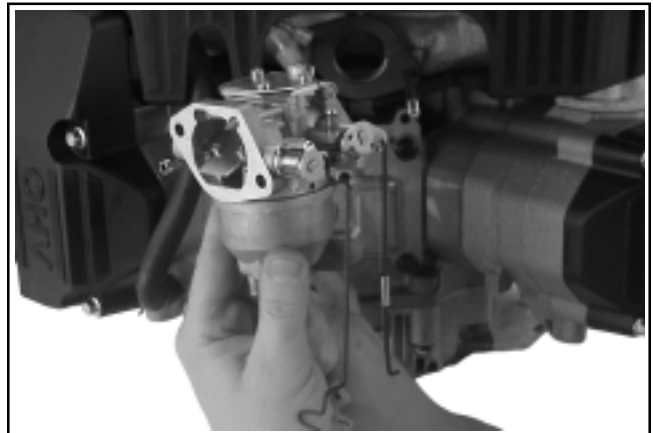


Figure 11-93. Attaching Linkages onto Carburetor.

## Section 11 Reassembly

---

3. Install the carburetor as an assembly, onto the carburetor studs. See Figure 11-94. Carefully lift up on the lower blower housing, directly above the carburetor, and slide the carburetor into place against the gasket and manifold.

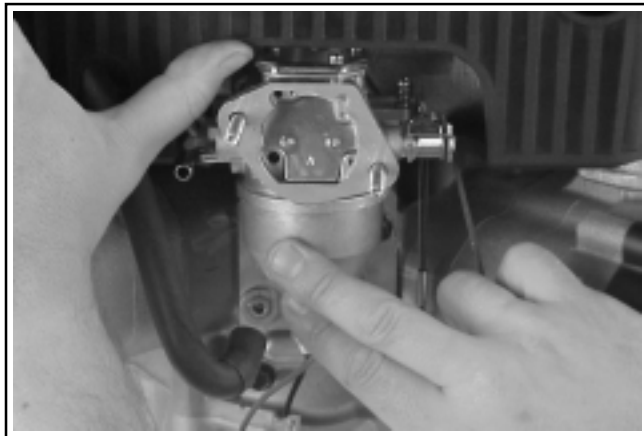


Figure 11-94. Installing Carburetor.

### Install External Governor Controls

1. Install the governor lever onto the governor cross shaft. See Figure 11-95.

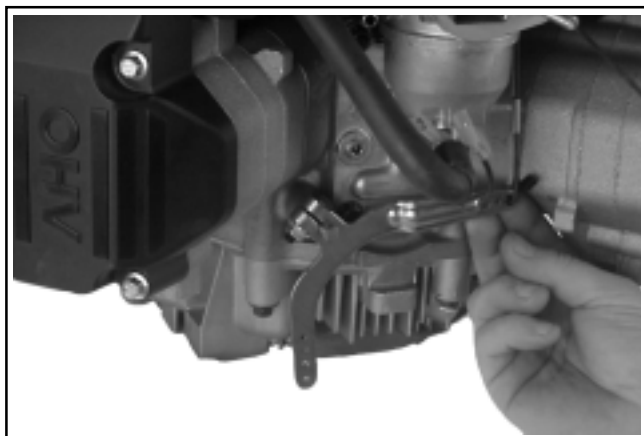


Figure 11-95. Installing Governor Lever onto Governor Shaft.

2. Insert the plastic bushing clip and connect the throttle linkage to the governor lever. Connect the dampening spring into the adjacent hole in the governor lever.

3. Pivot the governor lever **toward** the carburetor as far as it will move (wide-open throttle) and hold in position.
4. Insert a nail into the hole in the cross shaft and rotate the shaft **counterclockwise** as far as it will turn, then **torque** the hex. nut on the clamp screw to **9.9 N·m (88 in. lb.)**. See Figure 11-96. If, after torquing, no gap exists between the metal clamp surfaces, replace the governor lever.

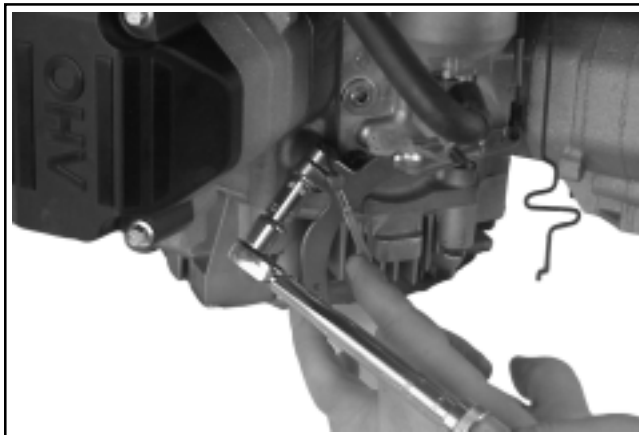


Figure 11-96. Torquing Governor Lever Clamp Hardware.

5. Connect the two wire leads for the fuel shut-off solenoid (if so equipped) to the wiring harness leads.

### Install Throttle Controls

1. Connect the choke linkage from the carburetor into the choke actuator lever on the speed control bracket assembly. See Figure 11-97.

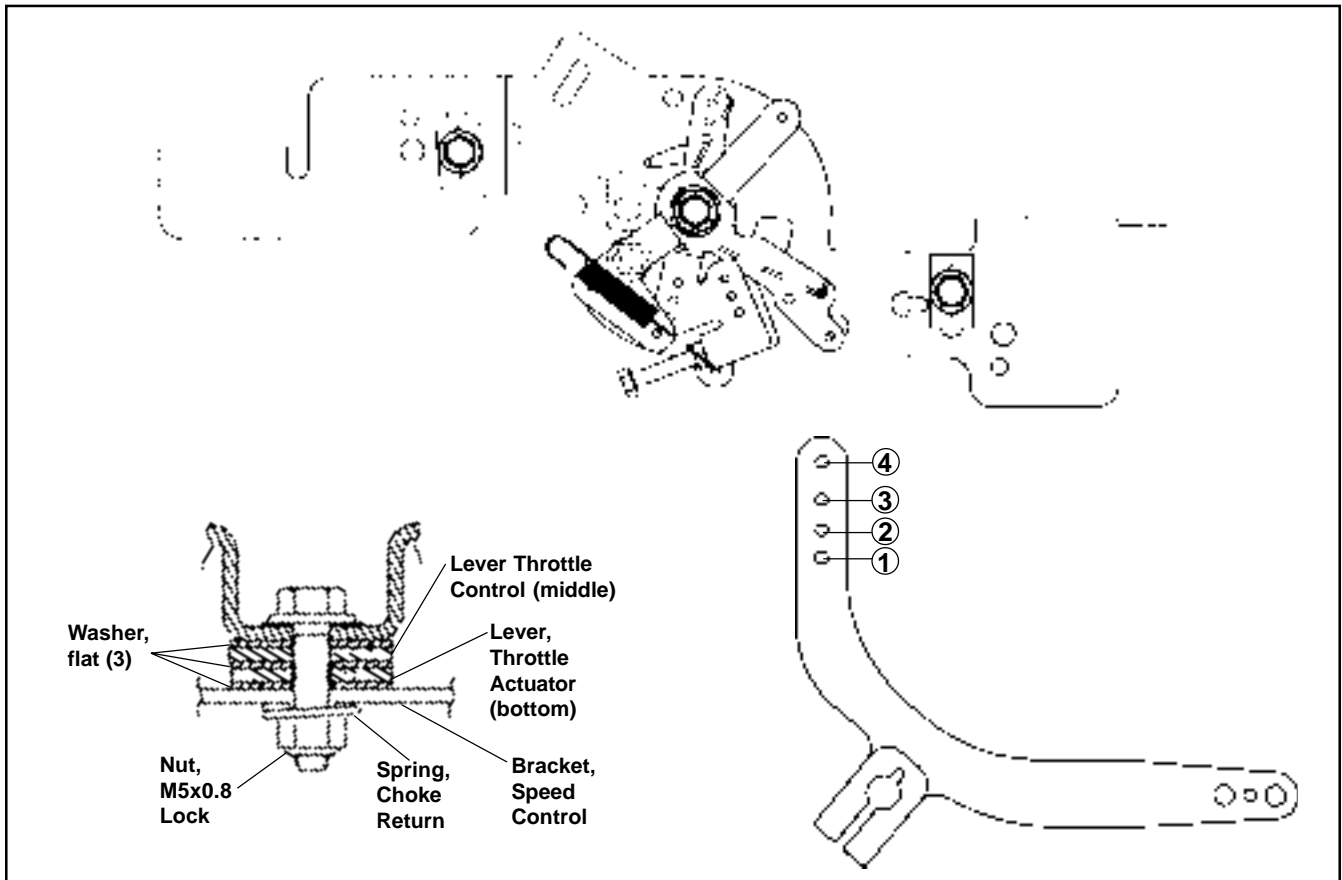


Figure 11-97. Throttle/Choke Control Bracket and Governor Lever Detail.

2. Connect the governor spring from the throttle control pivot lever on the main bracket to the appropriate hole in the governor lever, as indicated in the following chart. Note that the hole positions are counted outward from the governor shaft.
3. Attach the main control bracket to the cylinder heads using the four hex. flange screws. Torque the screws to **10.7 N·m (95 in. lb.)** if the heads are new, or to **7.3 N·m (65 in. lb.)** if the holes were used previously. See Figure 11-98.

### Governor Spring Chart

High Idle RPM	Governor Lever Hole No.	Governor Spring Color Code
3888	4	Red
3780	3	Purple
3672	3	Black
3564	3	Red
3456	2	Purple
3348	2	Green
3240	2	Red
3132	2	Clear
3024	1	Red

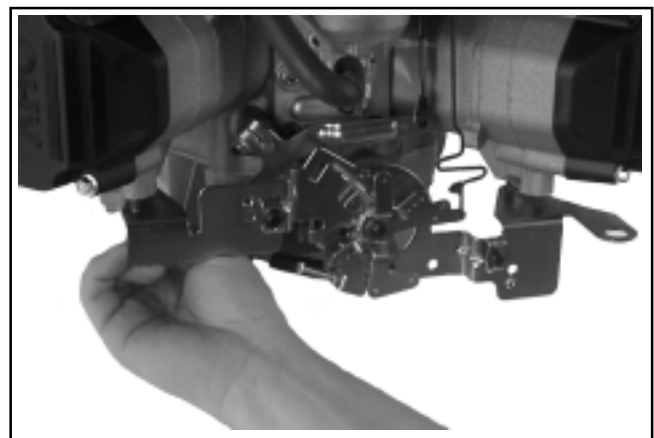


Figure 11-98. Attaching Main Bracket with Four Screws.

## Section 11

### Reassembly

#### Install Fuel Pump

1. Mount the fuel pump, with the lines attached, onto the blower housing, using the two hex. flange screws. Torque the screws to **2.3 N-m (20 in. lb.)**. See Figure 11-99.



Figure 11-99. Fuel Pump Mounting.

2. Slide the retaining clip (if removed previously) with the loop down and out, onto the fuel pump outlet hose for mounting later. Attach the outlet hose from the pump to the carburetor inlet, and the pulse hose to the crankcase fitting. See Figure 11-100. Secure on each end with the respective clamp. Connect the inlet line (with the fuel filter) after reassembly is completed.

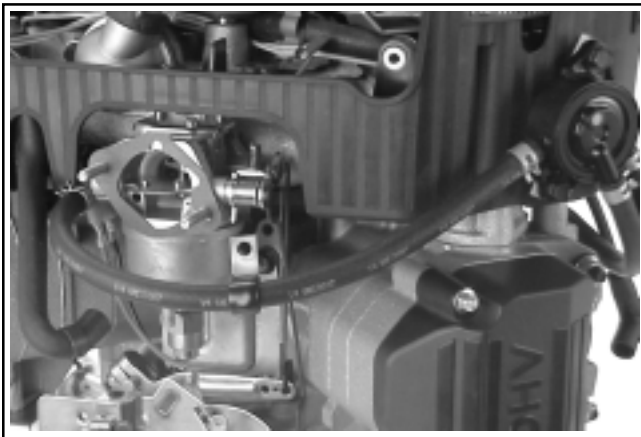


Figure 11-100. Hose Connected with Clip Loose.

#### Install Air Cleaner Base

1. Install a new air cleaner base gasket onto the carburetor studs.
2. Install the air cleaner base onto the carburetor studs. Attach the clip around the fuel line onto the right side stud and install the two hex. flange nuts onto the studs to secure. Torque the nuts to **9.9 N-m (88 in. lb.)**.
3. Connect the breather hose to the port fitting of the air cleaner base and secure with the clamp.
4. Install the air cleaner element onto the base and secure in place with the retainer strap. See Figure 11-101.

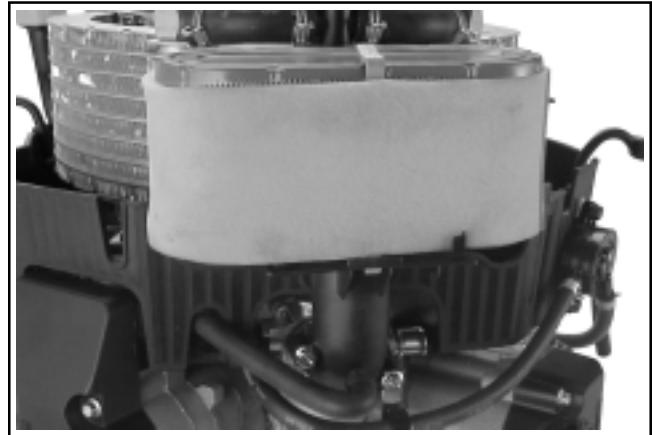


Figure 11-101. Completed Installation of Air Cleaner Parts.

5. Install the serviced precleaner around the air cleaner element, **outside** of the retainer. Completed installation is shown in Figure 11-101.

#### Recheck Governor Linkage Setting

1. Unhook the dampening spring and throttle linkage from the governor arm. Remove the black bushing.
2. Move the governor lever **towards** the carburetor as far as it will move and hold in position. Do not apply any extra pressure. Pivot the throttle linkage to the "full throttle" position.
3. Check how the end of the linkage aligns with the hole in the lever. The end of the linkage should be in the center of the hole. See Figure 11-102. If it is not the governor lever must be readjusted.

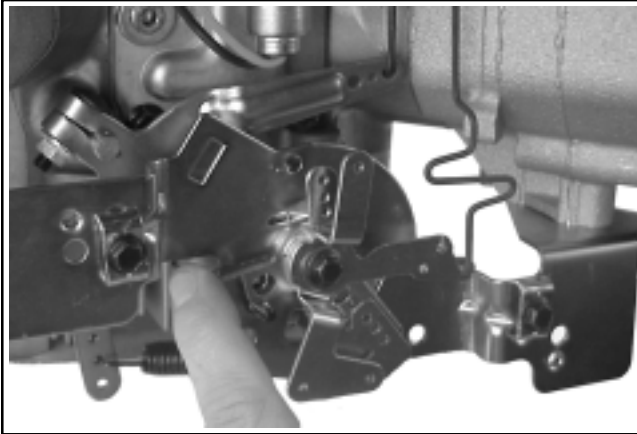


Figure 11-102. Rechecking Governor Linkage Adjustment.

4. After adjustment is correct, reinstall the black bushing and linkage into the governor lever.

### Install Muffler

1. Install the muffler or exhaust system to the exhaust port studs. Torque hex. flange nuts to **24.4 N·m (216 in. lb.)**. See Figure 11-103.



Figure 11-103. Installing Muffler.

### Install Oil Filter

1. Prefill the oil filter following the instructions in Section 6.
2. Apply a thin coating of engine oil to the rubber gasket of the oil filter and thread the filter onto the adapter nipple.
3. Hand tighten the filter until the rubber gasket contacts the adapter, then tighten the filter an additional 2/3-1 turn. See Figure 11-104.

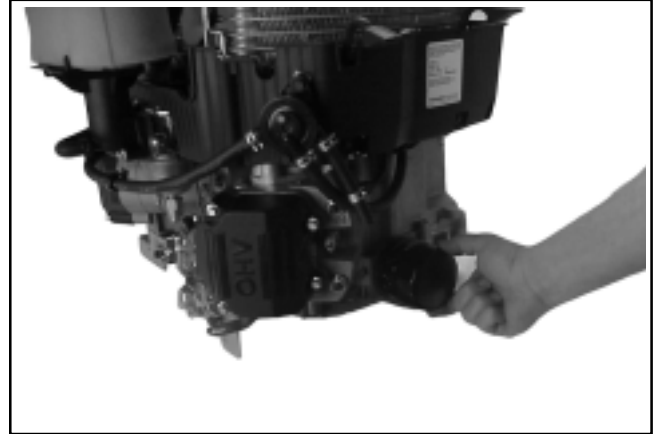


Figure 11-104. Installing Oil Filter.

### Fill Crankcase with Oil

1. Install the oil drain plug(s). See Figure 11-105. Torque the plug(s) to **13.6 N·m (120 in. lb.)**.

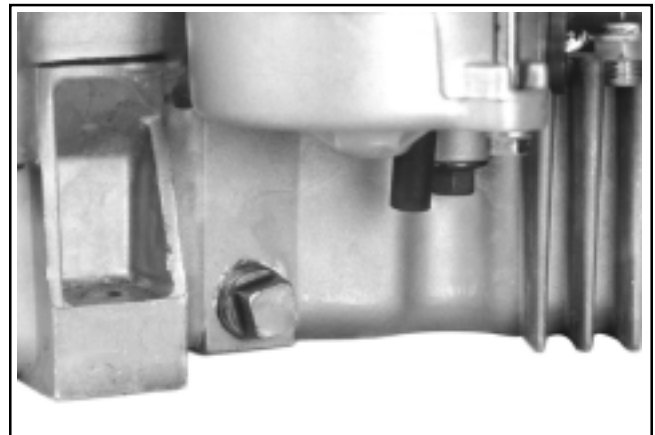


Figure 11-105. Install Oil Drain Plug(s).

NOTE: Make sure that both oil drain plugs are installed and torqued to the above specifications to prevent oil leakage.

2. Add oil of the proper viscosity to bring it up to the "Full" mark on the dipstick.
3. Install the dipstick into the tube.

### Fill Cooling System

NOTE: To prevent engine damage, **do not** use anti-freeze mixture with more than 70% ethylene glycol in the cooling system. **Do not** use anti-freeze with stop-leak additive(s) or mix/add other additives to the cooling system. Cooling system capacity is approximately 1.4 liters (1.47 qt.).

## Section 11 Reassembly

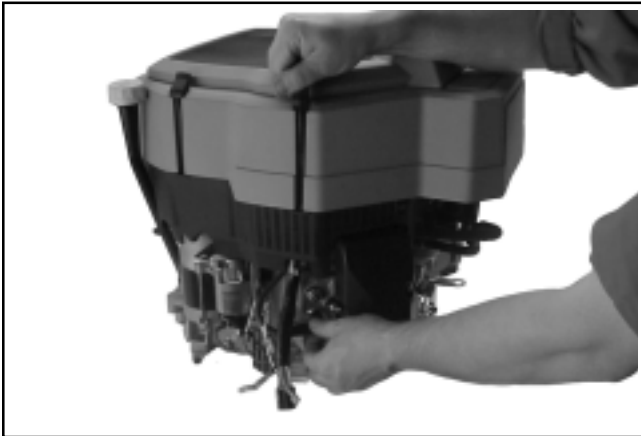
---

1. Use equal parts of ethylene glycol (anti-freeze) and water only. Distilled or deionized water is recommended, especially in areas where the water contains a high mineral content. Propylene glycol based anti-freeze is not recommended.
2. Fill the cooling system, through neck for radiator cap, with the coolant mix. Allow the coolant to drain into the lower areas. Fill the overflow reservoir midway between the “Min. Level” and “Max. Level” marks, then install the radiator and reservoir caps. See Figure 11-106.



**Figure 11-106. Reservoir Levels.**

3. Install the upper blower housing and screen assembly. Secure with the four retainer straps. See Figure 11-107.



**Figure 11-107. Securing Retainer Straps and Connecting Spark Plug Leads.**

### Reconnect Battery and Spark Plug Leads

Connect the leads to the spark plugs. Reconnect the positive battery lead first, and the negative (-) lead last when reconnecting the battery. See Figure 11-107.

### Testing the Engine

It is recommended that the engine be operated on a test stand or bench prior to installation in the application.

1. Make sure all hardware is tightened, and hose clamps are properly secured.
2. Set up the engine on a test stand. Install an oil pressure gauge (Kohler Part No. 25 761 06-S is recommended). Start the engine and check to be certain that oil pressure (20 psi or more) is present. Run for 5-10 minutes between idle and mid-range.
3. Check all cooling system components and joint connections for leaks.
4. Make sure the maximum engine speed does not exceed 3750 RPM (no load). Adjust the throttle, choke controls and high speed stop as necessary. Refer to the “Fuel System and Governor” section.
5. Place the throttle control into the “idle” or “slow” position and check the low idle speed (RPM). Refer to section 5 if adjustment is required.
6. Stop the engine.
7. Remove the blower housing and recheck coolant level in reservoir. Coolant level should be between the “Max. Level” and “Min. Level” marks. Add coolant if required. See Figure 11-106.
8. Reinstall the upper blower housing and screen assembly. Secure with the four retainer straps.

FOR SALES AND SERVICE INFORMATION  
IN U.S. AND CANADA, CALL  
**1-800-544-2444**

**KOHLER**engines  
**BORN TO RUN**

ENGINE DIVISION, KOHLER CO., KOHLER, WISCONSIN 53044

FORM NO.:	TP-2509
ISSUED:	9/01
REVISED:	
MAILED:	10/01

LITHO IN U.S.A.